

20
22

ORNO

more than
20
YEARS OF
Living **innovations**

home
automation

lighting

electric

Katalog produktów

PRODUCT CATALOGUE

Niniejszy materiał ma charakter wyłącznie informacyjny i nie stanowi oferty handlowej w rozumieniu Kodeksu Cywilnego. Zawarte w nim informacje były aktualizowane na dzień publikacji. W związku z nieustannym udoskonalaniem naszych produktów zastrzegamy sobie prawo do zmiany ich parametrów technicznych.

The present product catalogue is for guidance only and cannot be considered as a trade offer, within the meaning of the Polish Civil Code. All information presented herein has been updated as on its publishing date. In relation to a continuous development of our product portfolio, we reserve the right to change technical parameters of the products.



more than

20
YEARS OF

Living innovations

Jesteśmy polską, rodzinną firmą.
Od 2000 roku dostarczamy na rynek innowacyjne produkty,
a nasze nowe pomysły szybko przekuwamy w efektywne
i sprawdzone rozwiązania. Właśnie dlatego nasze produkty zyskały uznanie
i silną pozycję na rynku polskim i europejskim.

We are a Polish, family-owned company.
We have been supplying innovative products to the market since the year 2000,
and our new ideas are quickly converted into effective and proven solutions.
That is why our products have gained recognition
and a strong position on the Polish and European market.



> 100

Wykwalifikowanych
pracowników

DEDICATED AND QUALIFIED
EMPLOYEES

> 2400

Pozycji
asortymentowych

ITEMS IN PRODUCT RANGE

> 1700

Regularnych
klientów

REGULAR CLIENTS

> 1,8 mln

Produktów
sprzedawanych rocznie

PRODUCTS SOLD ANNUALLY

ORNO w liczbach

OUR NUMBERS

**Nie stoimy w miejscu.
Dzisiaj jesteśmy lepsi niż byliśmy wczoraj
- i robimy wszystko
by jutro móc powiedzieć to samo...**

Rafał Owczarek
Prezes zarządu / President

**We never stand still.
Today we are better than we were yesterday
- and we do everything
to be able to say the same thing tomorrow...**

Rafał Owczarek
Prezes zarządu / President

.....
Konsekwentna realizacja planów i strategii przyjętych w 2019 roku. Oferta firmy to ponad 1900 indeksów magazynowych.
.....
Uruchomienie dodatkowego magazynu o powierzchni 1800m², zlokalizowanego na terenie Parku Magazynowego Panattoni II w Gliwicach.

.....
Consistency in fulfilment of plans and strategies set for the year 2019. Company's offer includes over 1900 product indexes. Launching of the additional 1800m² warehouse situated in Panattoni II Park in Gliwice.



Poznaj nas bliżej.
GET TO KNOW US.



2019

2020

2021

vibell**NORGEN****Adviti****ViRONE**

.....
Reorganizacja struktury organizacyjnej firmy.
Utworzenie Działu Zarządzania Produktem. Intensywne prace nad rozwojem oferty produktowej. Zaprojektowanie nowej strategii dla portfela marek. Wydzielenie nowych marek produktowych: Vibell, Norgen, Adviti, Virone.

.....
Remodelling of organizational structure. Creation of Product Development Department. Intensive works aiming to develop product portfolio. Development of a new strategy for our product portfolio. Establishing new product brands: Vibell, Norgen, Adviti, Virone.



.....
Zakończenie realizacji etapu B inwestycji - budowy siedziby głównej wraz z centrum logistycznym.
Łączna powierzchnia obiektu wzrosła do 6000m² powierzchni magazynowej oraz 1700m² zaplecza biurowego.

.....
Completing phase B of the investment - construction of company's head office and its logistic hub.
Total area of the facility will increase to 6000m² of warehouse space and 1700m² of office space.



Przekształcenie jednoosobowej działalności w spółkę cywilną, której udziałowcami zostają Wiesław Owczarek oraz Rafał Owczarek. Następuje zmiana nazwy firmy na ORNO Export-Import oraz rozpoczęcie działalności importowej.

The company has been transformed from a one-man company to a partnership company with two shareholders: Wiesław Owczarek and Rafał Owczarek. The company's name was changed to "ORNO Export-Import" and the company started operating as a small importer.

Zakończenie inwestycji i przeprowadzka firmy do nowego obiektu biurowo - magazynowego w Mikołowie o powierzchni 1600 m².

Completion of the investment and moving the company into a new office and warehouse facility in Mikołów with an area of 1600 m².



1991

Wiesław Owczarek zakłada mały zakład poligraficzny, funkcjonujący pod nazwą Zakład Poligraficzny ORNO.

Wiesław Owczarek sets up a small company operating in printing branch, named Zakład Poligraficzny ORNO.

2000

2007



Zakończenie inwestycji i przeprowadzka firmy do nowego obiektu biurowego w Łaziskach Górnych o powierzchni biurowej 320 m² z przyległym magazynem o powierzchni 400 m². Zmiana nazwy firmy na „ORNO-POLSKA”.

Completing the investment and relocation to a new modern office building in Łaziska Górne with the office area of 320 m² and 400 m² storehouse. At that time the company's name was changed again to "ORNO-POLSKA".

2010

2012

Umożliwienie naszym Partnerom Handlowym współpracy z ORNO za pośrednictwem dedykowanej platformy B2B.

Allowing our Partners to cooperate with ORNO through the dedicated B2B platform.



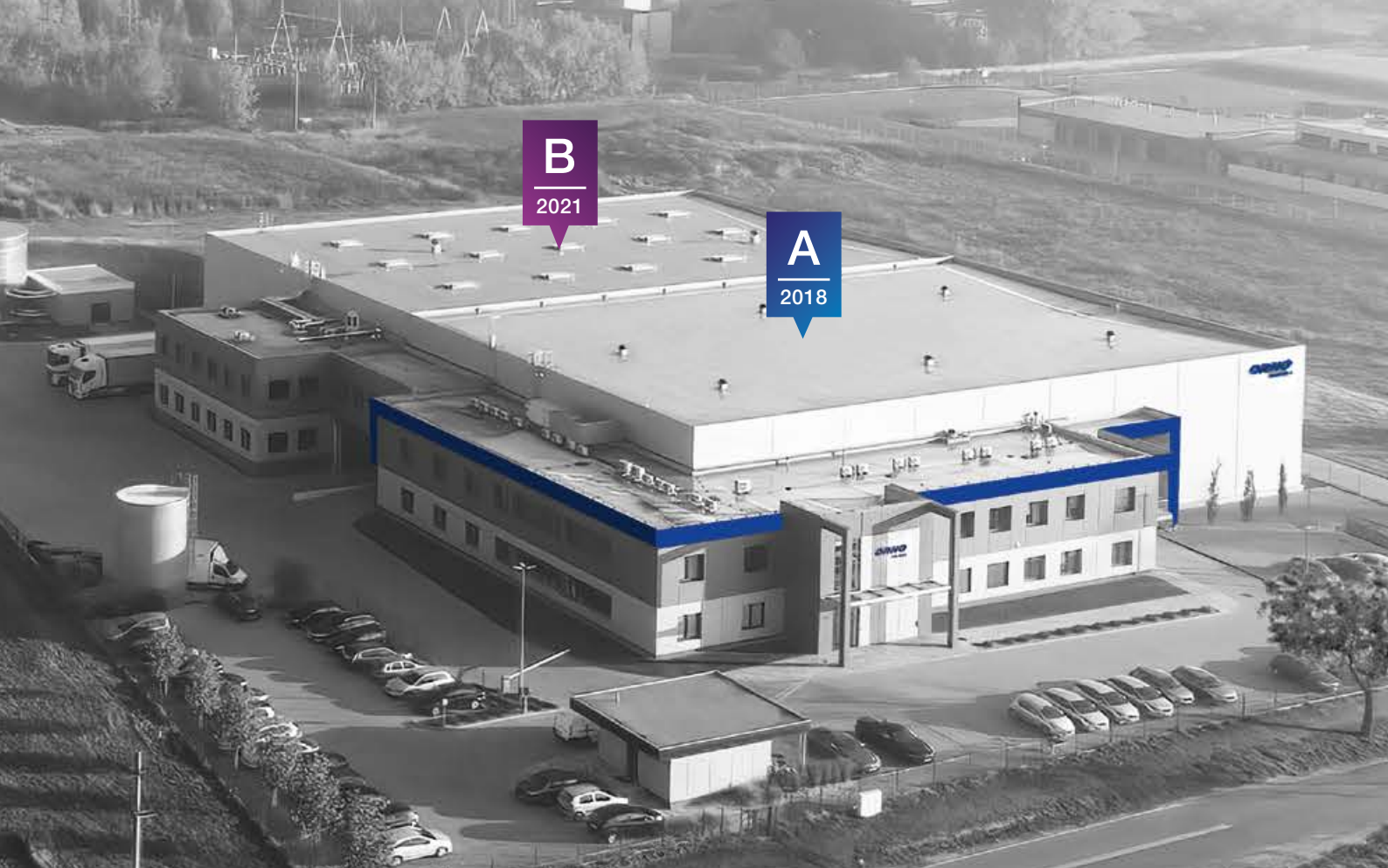

B
2021

A
2018

Stworzenie Działu Jakości oraz procedur związanych z procesem produkcji naszych produktów.

Creating a Quality Department and developing procedures to control production of our products.



Wybudowanie drugiego magazynu o powierzchni 1000 m².

Building a second storehouse with the area of 1000m².



Ukończenie inwestycji oraz przeprowadzka do nowej siedziby firmy zlokalizowanej w Gliwicach przy ul. Rolników. Nowy obiekt posiada 3000 m² magazynu wysokiego składowania oraz 1200 m² powierzchni biurowych.

Completing the investment and relocating to the new head office located in Gliwice, ul. Rolników. The new facility has 3000 m² of high-bay warehouse and 1200 m² of office space.



2013

2014

2015

2017

2018



Utworzenie Działu Eksportu. Rozpoczęcie ekspansji na rynkach zagranicznych. Pozyskanie pierwszych klientów z Niemiec, Francji, Ukrainy, Czech oraz Rumunii.

Creation of Export Department. Start of expansion into foreign markets. Acquiring first customers from Germany, France, Ukraine, Czech Republic and Romania.

Welcome in our world of
LIVING INNOVATIONS



Aktualizacja strategii handlowej firmy. Wyróżnienie 4 głównych linii produktowych. Zaprojektowanie i wdrożenie odświeżonego wizerunku opakowań produktów, nawiązujących do nowej strategii firmy.

Updating the company's business strategy. Distinction of 4 main product lines. Implementing a refreshed design of product packaging related to the company's new strategy.

Struktura portfela marek

BRAND PORTFOLIO STRUCTURE



nasze marki

OUR BRANDS

Welcome in our world.
World of living innovations.

Oferta podstawowa | Basic offer

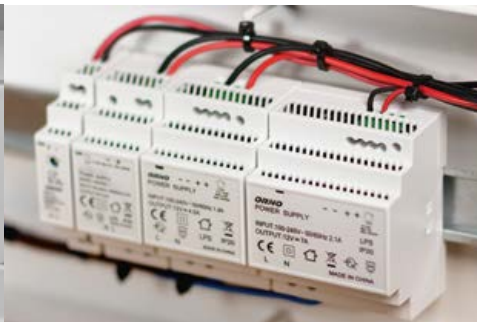

Experts for Professionals.
Electric equipment for Professionals.

Oferta podstawowa | Basic offer

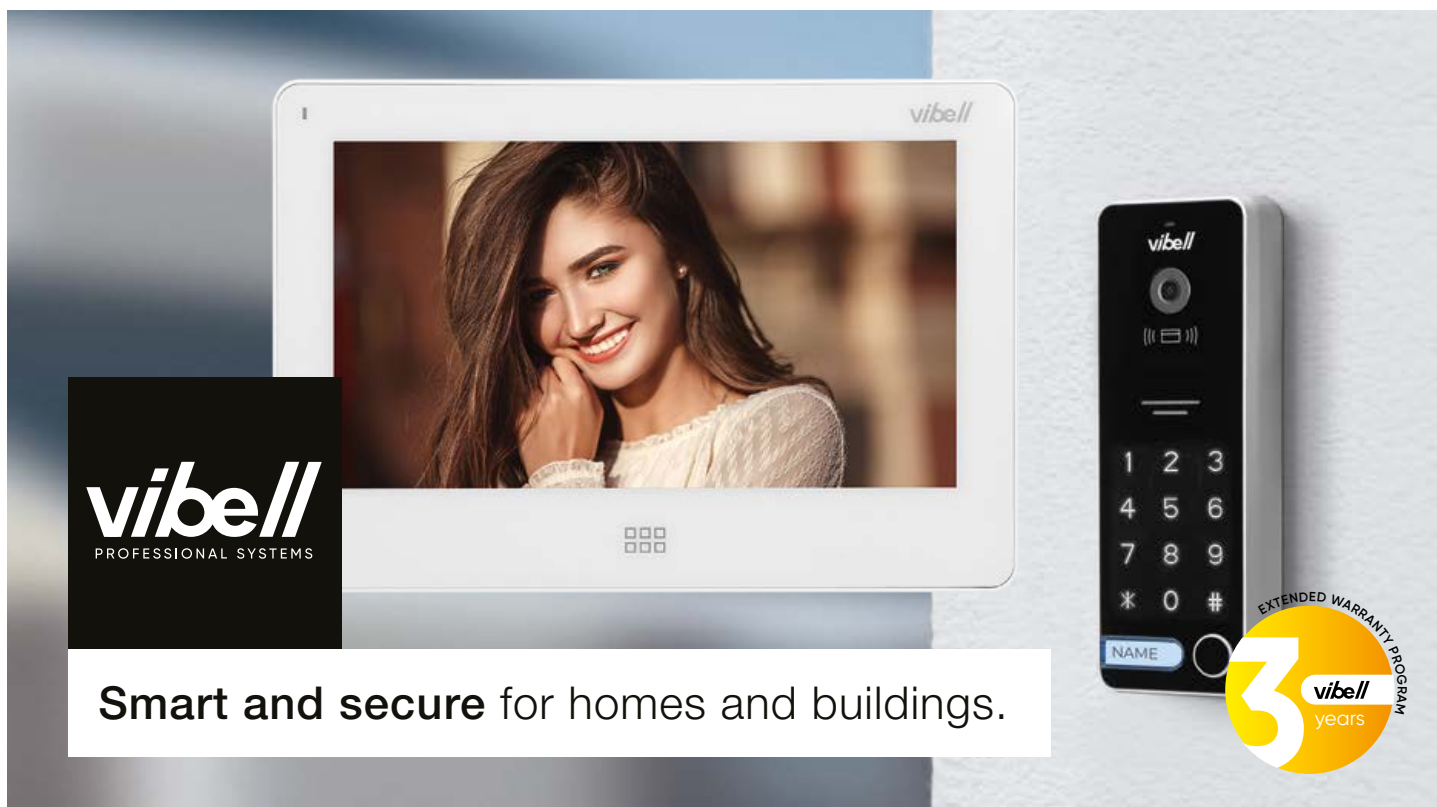

The advertisement features a white Vibell smart door lock with a large display screen showing a smiling woman. To the right is a black keypad with a numeric keypad and a 'NAME' button. A yellow circular badge in the bottom right corner contains the number '3' and the text 'vibell years' and 'EXTENDED WARRANTY PROGRAM'. The Vibell logo is in the bottom left.

vibell
PROFESSIONAL SYSTEMS

Smart and secure for homes and buildings.

EXTENDED WARRANTY PROGRAM
3 vibell years

Oferta podstawowa | Basic offer



The advertisement shows a wall with several black, cube-shaped recessed lights that cast a warm, yellow glow. The Adviti logo is in the bottom left, and a white text box at the bottom contains the slogan 'Adorn your home with light.'.

Adviti
LIGHTING SOLUTIONS

Adorn your home with light.

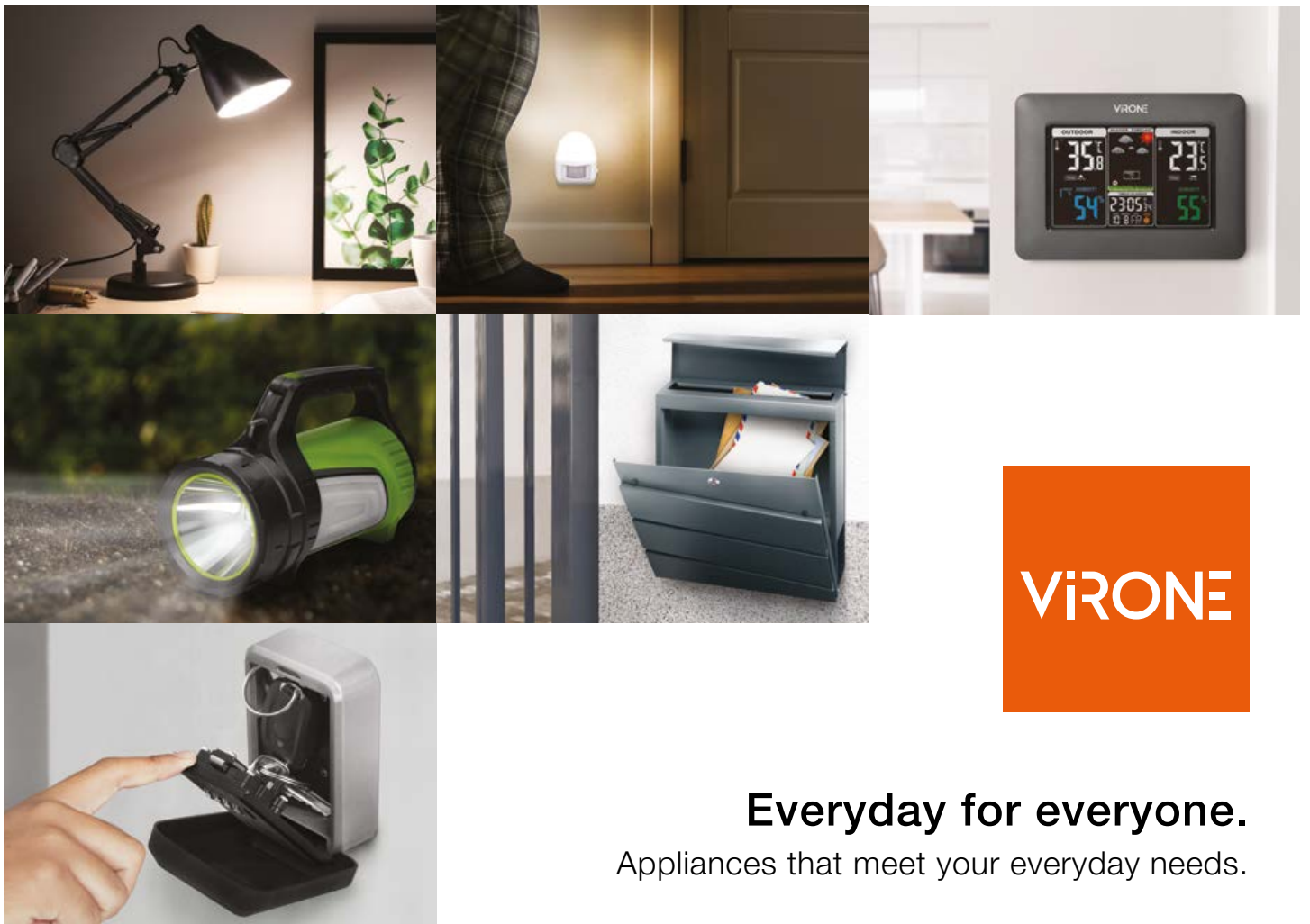

Oferta uzupełniająca | External offer



Pozostałe marki | other brands

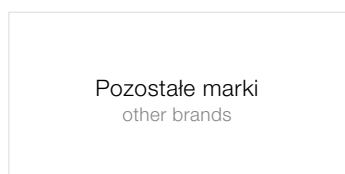

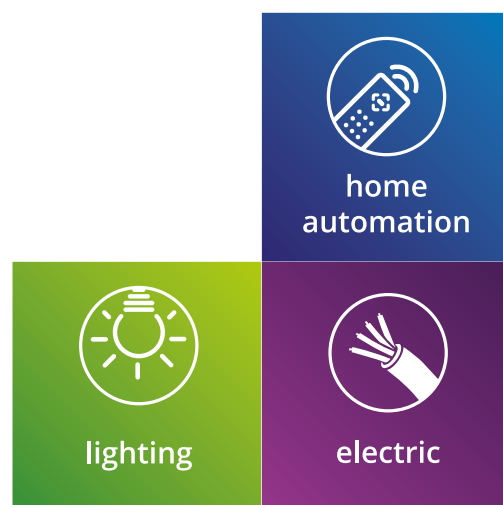

Spis treści

TABLE OF CONTENTS

20

Domotyka HOME AUTOMATION

Dzwonki przewodowe WIRED DOORBELLS	20
Dzwonki bezprzewodowe WIRELESS DOORBELLS	32
Domofony DOORPHONES	42
Wideodomofony VIDEODOORPHONES	52
Systemy wideodomofonowe VIDEODOORPHONE SYSTEMS	61
Wizjery elektroniczne DOOR VIEWERS	68
Zestaw interkomowy INTERCOM KIT	71

72

Kontrola dostępu ACCESS CONTROL

Kontrola dostępu ACCESS CONTROL	72
Elektrozaczepy ELECTRIC STRIKES	84

86

Alarmy i monitoring ALARMS AND MONITORING

Mini alarmy MINI ALARMS	86
Atrapy kamer CCTV DUMMY SECURITY CCTV CAMERAS	90

Detektory DETECTORS

Detektory DETECTORS	92
------------------------------	----

Czujniki ruchu MOTION SENSORS

Czujniki ruchu MOTION SENSORS	97
--	----

Sterowanie bezprzewodowe WIRELESS CONTROL

Sterowanie bezprzewodowe WIRELESS CONTROL	104
--	-----

116

Oprawy architektoniczne ARCHITECTURAL LIGHTING

Oprawy oświetleniowe LED LED LUMINAIRES	116
Oprawy downlight LED DOWNLIGHT.....	123
Oprawy decor DECOR LUMINAIRES.....	137
Oprawy liniowe BATTEN LIGHTS.....	141
Oprawy schodowe STAIRCASE LUMINAIRE.....	143
Naświetlacze LED LED FLOODLIGHTS.....	145
Oprawy ogrodowe GARDEN LUMINAIRES.....	150

Oświetlenie robocze WORK LIGHTING

Oświetlenie robocze WORK LIGHTING	160
--	-----

Highbay HIGHBAY

Highbay HIGHBAY.....	164
-------------------------	-----

Źródła światła LIGHT SOURCES

Źródła światła LIGHT SOURCES	165
---------------------------------------	-----

Pozostałe oświetlenie OTHER LIGHTING

Pozostałe oświetlenie OTHER LIGHTING.....	168
--	-----

172

Aparatura modułowa MODULAR DEVICES

Liczniki energii POWER METERS	172
Zasilacze POWER SUPPLY UNITS	174
Listwy zaciskowe BRASS BUSBARS	178
Bloki rozdzielcze DISTRIBUTION BLOCKS	180

184

Zasilacze POWER SUPPLY UNITS

Zasilacze modułowe MODULAR POWER SUPPLY UNITS	184
Zasilacze open frame OPEN FRAME POWER SUPPLY UNITS	184
Zasilacze LED do puszki LED POWER SUPPLY UNITS, FLUSH-MOUNTED	185
Zasilacze do LED LED POWER SUPPLY UNITS	185

191

Osprzęt elektroinstalacyjny ELECTRICAL INSTALLATION EQUIPMENT

Watomierze POWER METERS	191
Programatory czasowe TIMERS	192
Gniazda i wtyczki SOCKETS AND PLUGS	193
Przełączniki SWITCHES	194
Rozgałęźniki POWER SOCKET SPLITTERS	196
Gniazda i wtyczki warsztatowe WORKSHOP SOCKETS AND PLUGS	198
Rozgałęźniki bryzgoszczelne HEAVY-DUTY EXTENSION SOCKETS	200
Gniazda i wtyczki przyczepy TRAILER PLUGS AND SOCKETS	201
Inne MISCELLANEOUS	202

206

Przedłużacze EXTENSION CORDS

Przedłużacze domowe HOME CABLE REELS	206
Przedłużacze bębnowe, domowe HOME CABLE REELS	212
Przedłużacze ogrodowe GARDEN EXTENSION CORDS	213
Przedłużacze warsztatowe WORKSHOP EXTENSION SOCKETS	217
Przedłużacze bębnowe, warsztatowe WORKSHOP CABLE REELS	220

224

Gniazda meblowe FURNITURE SOCKETS

Gniazda wpuszczane FLUSH MOUNTED SOCKETS	224
Gniazda nabladowe COURTERTOP SOCKETS	246
Gniazda podszaikowe UNDER-CABINET SOCKETS	248

254

Technika łaczeniowa CONNECTION TECHNIQUE

Konektory kablowe CABLE CONNECTORS	254
Konektory fotowoltaiczne PHOTOVOLTAIC CONNECTORS	256
Szybkozłaczki SPLICING CONNECTORS	257
Puszki żelowe GEL BOXES	259
Końcówki kablowe CABLE LUGS	260

268

Akcesoria elektroinstalacyjne ELECTRICAL INSTALLATION ACCESSORIES

Puszki podtynkowe IN-WALL JUNCTION BOXES	268
Taśmy izolacyjne INSULATION TAPES	269
Opaski kablowe CABLE TIES	270
Koszulki termokurczliwe HEAT SHRINKABLE TUBES	272
Testery napięcia VOLTAGE TESTERS	273

Wentylatory łazienkowe BATHROOM FANS

Wentylatory łazienkowe BATHROOM FANS	274
---	-----

home automation line



20

Domotyka

HOME AUTOMATION

Dzwonki przewodowe WIRED DOORBELLS	20
Dzwonki bezprzewodowe WIRELESS DOORBELLS	32
Domofony DOORPHONES	42
Wideodomofony VIDEODOORPHONES	52
Systemy wideodomofonowe VIDEODOORPHONE SYSTEMS	61
Wizjery elektroniczne DOOR VIEWERS	68
Zestaw interkomowy INTERCOM KIT	71

72

Kontrola dostępu

ACCESS CONTROL

Kontrola dostępu ACCESS CONTROL	72
Elektrozaczepy ELECTRIC STRIKES	84

86

Alarmy i monitoring

ALARMS AND MONITORING

Mini alarmy MINI ALARMS	86
Atrapy kamer CCTV DUMMY SECURITY CCTV CAMERAS	90

Detektory

DETECTORS

Detektory DETECTORS	92
------------------------------	----

Czujniki ruchu

MOTION SENSORS

Czujniki ruchu MOTION SENSORS	97
--	----

Sterowanie bezprzewodowe

WIRELESS CONTROL

Sterowanie bezprzewodowe WIRELESS CONTROL	104
--	-----

DZWONKI PRZEWODOWE

WIRED DOORBELLS



BREVIS MAXI AC

Dzwonek elektromechaniczny dwutonowy
Electromechanical two-tone doorbell

Warianty produktu / Available options



OR-DP-MR-150/W



OR-DP-MR-150/PW

Główne cechy / Main features

Funkcja przeciwblokady łącznika
Switch anti-blocking function



2 tony DING-DONG
Two DING-DONG ringtones



Symbol Product no.	EAN	Zasilanie Power supply	Typ Type	Stopień ochrony Protection rating	Kolor Color	Wymiary (szer./wys./gt. [mm]) Dimensions (W/H/D [mm])
OR-DP-MR-150/W	5908254800641	230V~, 50Hz	elektromechaniczny electromechanical	IP20	biały white	105 / 162 / 36
OR-DP-MR-150/PW	5908254803642	230V~, 50Hz	elektromechaniczny electromechanical	IP20	śnieżno biały pure white	105 / 162 / 36

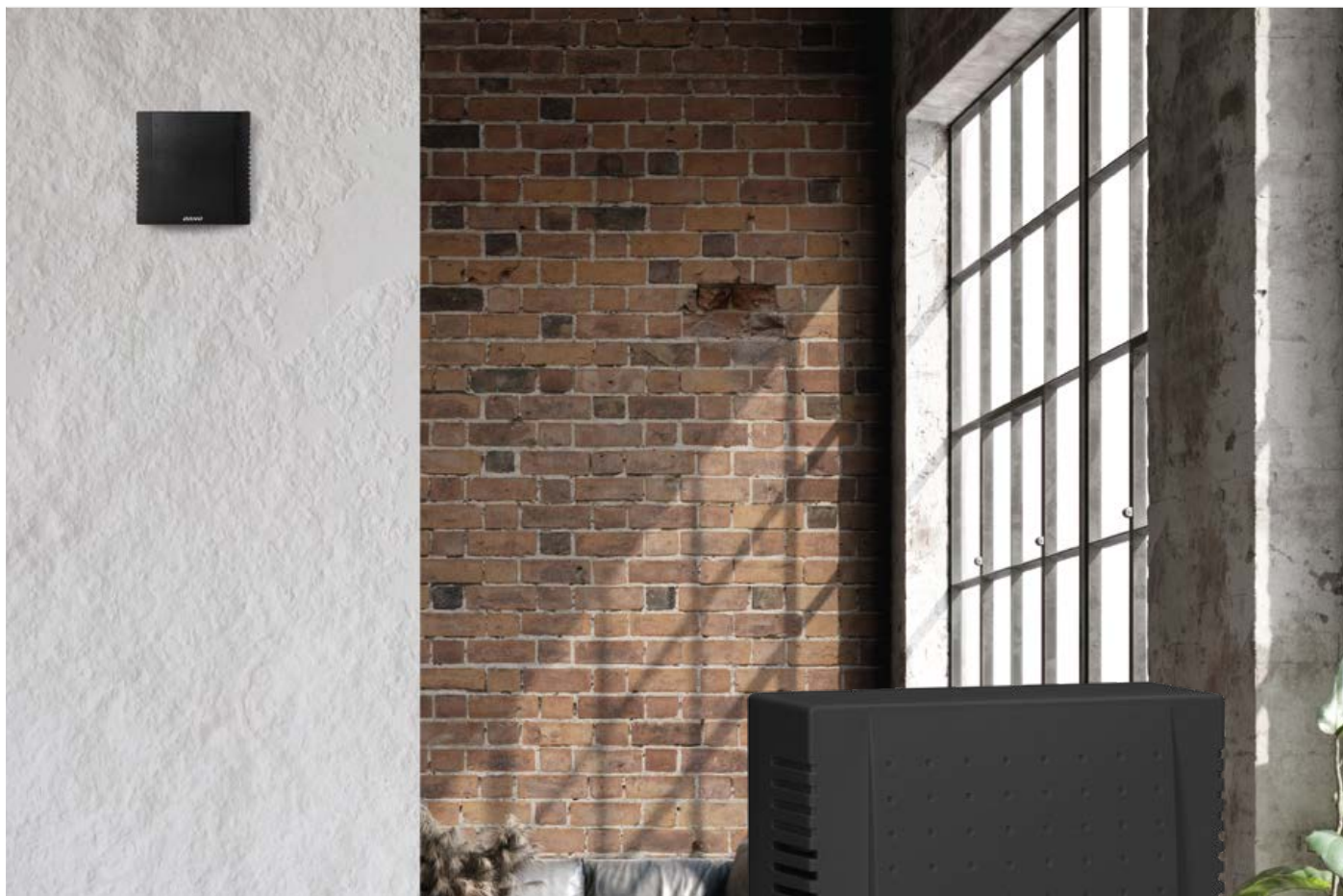

QUARTO AC

Dzwonek elektromechaniczny dwutonowy
Electromechanical two-tone doorbell



Warianty produktu / Available options

Główne cechy / Main features



Funkcja przeciwblokady łącznika
Switch anti-blocking function



2 tony DING-DONG
Two DING-DONG ringtones



OR-DP-MR-149/W



OR-DP-MR-149/PW



OR-DP-MR-149/B

Symbol Product no.	EAN	Zasilanie Power supply	Typ Type	Stopień ochrony Protection rating	Kolor Color	Wymiary (szer./wys./gł. [mm]) Dimensions (W/H/D [mm])
OR-DP-MR-149/W	5908254800658	230V~, 50Hz	elektromechaniczny electromechanical	IP20	biały white	110 / 110 / 39
OR-DP-MR-149/PW	5908254803635	230V~, 50Hz	elektromechaniczny electromechanical	IP20	śnieżno biały pure white	110 / 110 / 39
OR-DP-MR-149/B	5908254820229	230V~, 50Hz	elektromechaniczny electromechanical	IP20	czarny black	110 / 110 / 39

BREVIS MINI AC

Dzwonek elektromechaniczny dwutonowy
Electromechanical two-tone doorbell



Główne cechy / Main features

Funkcja przeciwblokady łącznika
Switch anti-blocking function



2 tony DING-DONG
Two DING-DONG ringtones



Warianty produktu / Available options



OR-DP-MR-148/W



OR-DP-MR-148/PW



OR-DP-MR-148/B

Symbol Product no.	EAN	Zasilanie Power supply	Typ Type	Stopień ochrony Protection rating	Kolor Color	Wymiary (szer./wys./gt. [mm]) Dimensions (W/H/D [mm])
OR-DP-MR-148/W	5908254800634	230V~, 50Hz	elektromechaniczny electromechanical	IP20	biały white	70 / 120 / 38
OR-DP-MR-148/PW	5908254821561	230V~, 50Hz	elektromechaniczny electromechanical	IP20	śnieżno biały pure white	70 / 120 / 38
OR-DP-MR-148/B	5908254820212	230V~, 50Hz	elektromechaniczny electromechanical	IP20	czarny black	70 / 120 / 38

RINGIL MINI AC

Dzwonek elektroniczny jednotonowy
Electronic one-tone doorbell



Główne cechy / Main features

1 pulsujący ton
One pulsating ringtone



Regulacja głośności
Volume adjustment



Warianty produktu / Available options



OR-DP-MR-160/W



OR-DP-MR-160/PW

Symbol Product no.	EAN	Zasilanie Power supply	Typ Type	Stopień ochrony Protection rating	Kolor Color	Wymiary (szer./wys./gt. [mm]) Dimensions (W/H/D [mm])
OR-DP-MR-160/W	5908254814532	230V~, 50Hz	elektroniczny electronic	IP20	biały white	109 / 109 / 39
OR-DP-MR-160/PW	5908254814679	230V~, 50Hz	elektroniczny electronic	IP20	śnieżno biały pure white	109 / 109 / 39

LARK MAXI ACDzwonek elektroniczny jednotonowy
Electronic one-tone doorbell**Główne cechy / Main features**1 pulsujący ton
One pulsating ringtoneRegulacja głośności
Volume adjustment**Warianty produktu / Available options**

OR-DP-MR-161/W



OR-DP-MR-161/PW



OR-DP-MR-161/B

Symbol Product no.	EAN	Zasilanie Power supply	Typ Type	Stopień ochrony Protection rating	Kolor Color	Wymiary (szer./wys./gl. [mm]) Dimensions (W/H/D [mm])
OR-DP-MR-161/W	5908254814549	230V~, 50Hz	elektroniczny electronic	IP20	biały white	105 / 163 / 37
OR-DP-MR-161/PW	5908254814686	230V~, 50Hz	elektroniczny electronic	IP20	śnieżno biały pure white	105 / 163 / 37
OR-DP-MR-161/B	5908254820601	230V~, 50Hz	elektroniczny electronic	IP20	czarny black	105 / 163 / 37

PLUSDzwonek elektromechaniczny dwutonowy
Electromechanical two-tone doorbell**Główne cechy / Main features**2 tony BIM-BAM
Two BIM-BAM ringtonesDwa warianty zasilania
Two power variants**Warianty produktu / Available options**OR-DP-VD-139/W
OR-DP-VD-139/W/8VOR-DP-VD-139/BG
OR-DP-VD-139/BG/8V

Symbol Product no.	EAN	Zasilanie Power supply	Typ Type	Stopień ochrony Protection rating	Kolor Color	Wymiary (szer./wys./gl. [mm]) Dimensions (W/H/D [mm])
OR-DP-VD-139/W	5900378654032	230V~, 50Hz	elektromechaniczny electromechanical	IP20	biały white	100 / 135 / 42
OR-DP-VD-139/BG	5900378654049	230V~, 50Hz	elektromechaniczny electromechanical	IP20	beżowy beige	100 / 135 / 42
OR-DP-VD-139/W/8V	5900378654056	8V~, 50Hz	elektromechaniczny electromechanical	IP20	biały white	100 / 135 / 42
OR-DP-VD-139/BG/8V	5900378654063	8V~, 50Hz	elektromechaniczny electromechanical	IP20	beżowy beige	100 / 135 / 42

STANDARD BIS

Dzwonek elektromechaniczny jednotonowy
Electromechanical one-tone doorbell



Główne cechy / Main features

Dwa warianty zasilania
Two power variants



Regulacja głośności
Volume adjustment



Warianty produktu / Available options

Symbol Product no.	EAN	Zasilanie Power supply	Typ Type	Stopień ochrony Protection rating	Kolor Color	Wymiary (szer./wys./gt. [mm]) Dimensions (W/H/D [mm])
OR-DP-VD-143/W	5900378654070	230V~, 50Hz	elektromechaniczny electromechanical	IP20	biały white	68 / 125 / 50
OR-DP-VD-143/W/8V	5900378654087	8V~, 50Hz	elektromechaniczny electromechanical	IP20	biały white	68 / 125 / 50

STANDARD

Dzwonek elektromechaniczny jednotonowy
Electromechanical one-tone doorbell



Główne cechy / Main features

Dwa warianty zasilania
Two power variants



Regulacja głośności
Volume adjustment



Warianty produktu / Available options

Symbol Product no.	EAN	Zasilanie Power supply	Typ Type	Stopień ochrony Protection rating	Kolor Color	Wymiary (szer./wys./gt. [mm]) Dimensions (W/H/D [mm])
OR-DP-VD-140/W	5900378654094	230V~, 50Hz	elektromechaniczny electromechanical	IP20	biały white	68 / 125 / 50
OR-DP-VD-140/W/8V	5900378654100	8V~, 50Hz	elektromechaniczny electromechanical	IP20	biały white	68 / 125 / 50

Dzwonek elektromechaniczny dwutonowy

Electromechanical two-tone doorbell

Główne cechy / Main features



2 tony BIM-BAM
Two BIM-BAM ringtones



Dwa warianty zasilania
Two power variants



Warianty produktu / Available options



OR-DP-VD-142/W
OR-DP-VD-142/W/8V



OR-DP-VD-142/BG
OR-DP-VD-142/BG/8V

Symbol Product no.	EAN	Zasilanie Power supply	Typ Type	Stopień ochrony Protection rating	Kolor Color	Wymiary (szer./wys./gt. [mm]) Dimensions (W/H/D [mm])
OR-DP-VD-142/W	5900378654179	230V~, 50Hz	elektromechaniczny electromechanical	IP20	biały white	100 / 135 / 42
OR-DP-VD-142/BG	5900378654186	230V~, 50Hz	elektromechaniczny electromechanical	IP20	beżowy beige	100 / 135 / 42
OR-DP-VD-142/W/8V	5900378654193	8V~, 50Hz	elektromechaniczny electromechanical	IP20	biały white	100 / 135 / 42
OR-DP-VD-142/BG/8V	5900378654209	8V~, 50Hz	elektromechaniczny electromechanical	IP20	beżowy beige	100 / 135 / 42

Dzwonek elektroniczny dwutonowy

Electronic two-tone doorbell

Główne cechy / Main features



2 tony BIM-BAM
Two BIM-BAM ringtones



Dwa warianty zasilania
Two power variants



Warianty produktu / Available options

Symbol Product no.	EAN	Zasilanie Power supply	Typ Type	Stopień ochrony Protection rating	Kolor Color	Wymiary (szer./wys./gt. [mm]) Dimensions (W/H/D [mm])
OR-DP-VD-147/W	5900378654377	230V~, 50Hz	elektroniczny electronic	IP20	biały white	65 / 125 / 50
OR-DP-VD-147/W/8V	5900378654384	8V~, 50Hz	elektroniczny electronic	IP20	biały white	65 / 125 / 50

Dzwonek elektroniczny dwutonowy

Electronic two-tone doorbell



Główne cechy / Main features

2 tony BIM-BAM
Two BIM-BAM ringtones



Dwa warianty zasilania
Two power variants



Warianty produktu / Available options

Symbol Product no.	EAN	Zasilanie Power supply	Typ Type	Stopień ochrony Protection rating	Kolor Color	Wymiary (szer./wys./gt. [mm]) Dimensions (W/H/D [mm])
OR-DP-VD-162/W	5908254815027	230V~, 50Hz	elektroniczny electronic	IP20	biały white	65 / 50 / 125
OR-DP-VD-162/W/8V	5908254815034	8V~, 50Hz	elektroniczny electronic	IP20	biały white	65 / 50 / 125

SONIC

Dzwonek elektroniczny dwutonowy

Electronic two-tone doorbell



Główne cechy / Main features

2 tony BIM-BAM
Two BIM-BAM ringtones



Dwa warianty zasilania
Two power variants



Warianty produktu / Available options

Symbol Product no.	EAN	Zasilanie Power supply	Typ Type	Stopień ochrony Protection rating	Kolor Color	Wymiary (szer./wys./gt. [mm]) Dimensions (W/H/D [mm])
OR-DP-VD-145/W	5900378654292	230V~, 50Hz	elektroniczny electronic	IP20	biały white	92 / 92 / 35
OR-DP-VD-145/W/8V	5900378654308	230V~, 50Hz	elektroniczny electronic	IP20	biały white	92 / 92 / 35

Główne cechy / Main features



Dwa warianty zasilania
Two power variants



2 tony BIM-BAM
Two BIM-BAM ringtones

Warianty produktu / Available options



OR-DP-VD-141/W
OR-DP-VD-141/W/8V



OR-DP-VD-141/BG
OR-DP-VD-141/BG/8V



OR-DP-VD-141/B
OR-DP-VD-141/B/8V

Dzwonek elektromechaniczny dwutonowy
Electromechanical two-tone doorbell

Symbol Product no.	EAN	Zasilanie Power supply	Typ Type	Stopień ochrony Protection rating	Kolor Color	Wymiary (szer./wys./gł. [mm]) Dimensions (W/H/D [mm])
OR-DP-VD-141/W	5900378654117	230V~, 50Hz	elektromechaniczny electromechanical	IP20	biały white	100 / 135 / 42
OR-DP-VD-141/BG	5900378654124	230V~, 50Hz	elektromechaniczny electromechanical	IP20	beżowy beige	100 / 135 / 42
OR-DP-VD-141/B	5900378654131	230V~, 50Hz	elektromechaniczny electromechanical	IP20	czarny black	100 / 135 / 42
OR-DP-VD-141/W/8V	5900378654148	8V~, 50Hz	elektromechaniczny electromechanical	IP20	biały white	100 / 135 / 42
OR-DP-VD-141/BG/8V	5900378654155	8V~, 50Hz	elektromechaniczny electromechanical	IP20	beżowy beige	100 / 135 / 42
OR-DP-VD-141/B/8V	5900378654162	8V~, 50Hz	elektromechaniczny electromechanical	IP20	czarny black	100 / 135 / 42

Główne cechy / Main features



Dwa warianty zasilania
Two power variants



2 tony BIM-BAM
Two BIM-BAM ringtones

Warianty produktu / Available options



OR-DP-VD-146/W
OR-DP-VD-146/W/8V



OR-DP-VD-146/BG
OR-DP-VD-146/BG/8V



OR-DP-VD-146/B
OR-DP-VD-146/B/8V

Dzwonek elektromechaniczny dwutonowy
Electromechanical two-tone doorbell

Symbol Product no.	EAN	Zasilanie Power supply	Typ Type	Stopień ochrony Protection rating	Kolor Color	Wymiary (szer./wys./gł. [mm]) Dimensions (W/H/D [mm])
OR-DP-VD-146/W	5900378654315	230V~, 50Hz	elektromechaniczny electromechanical	IP20	biały white	100 / 135 / 42
OR-DP-VD-146/BG	5900378654322	230V~, 50Hz	elektromechaniczny electromechanical	IP20	beżowy beige	100 / 135 / 42
OR-DP-VD-146/B	5900378654339	230V~, 50Hz	elektromechaniczny electromechanical	IP20	czarny black	100 / 135 / 42
OR-DP-VD-146/W/8V	5900378654346	8V~, 50Hz	elektromechaniczny electromechanical	IP20	biały white	100 / 135 / 42
OR-DP-VD-146/BG/8V	5900378654353	8V~, 50Hz	elektromechaniczny electromechanical	IP20	beżowy beige	100 / 135 / 42
OR-DP-VD-146/B/8V	5900378654360	8V~, 50Hz	elektromechaniczny electromechanical	IP20	czarny black	100 / 135 / 42

BITON PLUS

Dzwonek elektromechaniczny dwutonowy
Electromechanical two-tone doorbell



Główne cechy / Main features

2 tony BIM-BAM
Two BIM-BAM ringtones



Dwa warianty zasilania
Two power variants



Warianty produktu / Available options

Symbol Product no.	EAN	Zasilanie Power supply	Typ Type	Stopień ochrony Protection rating	Kolor Color	Wymiary (szer./wys./gl. [mm]) Dimensions (W/H/D [mm])
OR-DP-VD-138/W	5900378654018	230V~, 50Hz	elektromechaniczny electromechanical	IP20	biały white	100 / 135 / 42
OR-DP-VD-138/W/8V	5900378654025	8V~, 50Hz	elektromechaniczny electromechanical	IP20	biały white	100 / 135 / 42

KAMELEON

Dzwonek elektromechaniczny dwutonowy
Electromechanical two-tone doorbell



Główne cechy / Main features

2 tony BIM-BAM
Two BIM-BAM ringtones



Dwa warianty zasilania
Two power variants



Warianty produktu / Available options



OR-DP-VD-163/W-G
OR-DP-VD-163/W-G/8V

OR-DP-VD-163/W-C
OR-DP-VD-163/W-C/8V

Symbol Product no.	EAN	Zasilanie Power supply	Typ Type	Stopień ochrony Protection rating	Kolor Color	Wymiary (szer./wys./gl. [mm]) Dimensions (W/H/D [mm])
OR-DP-VD-163/W-G	5908254815041	230V~, 50Hz	elektromechaniczny electromechanical	IP20	biało-srebrny silver-white	140 / 145 / 40
OR-DP-VD-163/W-C	5908254815102	230V~, 50Hz	elektromechaniczny electromechanical	IP20	biało-złoty gold-white	140 / 145 / 40
OR-DP-VD-163/W-G/8V	5908254815058	8V~, 50Hz	elektromechaniczny electromechanical	IP20	biało-srebrny silver-white	140 / 145 / 40
OR-DP-VD-163/W-C/8V	5908254815119	8V~, 50Hz	elektromechaniczny electromechanical	IP20	biało-złoty gold-white	140 / 145 / 40

Główne cechy / Main features



2 tony BIM-BAM
Two BIM-BAM ringtones



Dwa warianty zasilania
Two power variants

Warianty produktu / Available options



OR-DP-VD-164/W
OR-DP-VD-164/W/8V



OR-DP-VD-164/B
OR-DP-VD-164/B/8V

Dzwonek elektromechaniczny dwutonowy
Electromechanical two-tone doorbell

Symbol Product no.	EAN	Zasilanie Power supply	Typ Type	Stopień ochrony Protection rating	Kolor Color	Wymiary (szer./wys./gł. [mm]) Dimensions (W/H/D [mm])
OR-DP-VD-164/W	5908254815065	230V~, 50Hz	elektromechaniczny electromechanical	IP20	biały white	125 / 155 / 40
OR-DP-VD-164/B	5908254815089	230V~, 50Hz	elektromechaniczny electromechanical	IP20	czarny black	125 / 155 / 40
OR-DP-VD-164/W/8V	5908254815072	8V~, 50Hz	elektromechaniczny electromechanical	IP20	biały white	125 / 155 / 40
OR-DP-VD-164/B/8V	5908254815096	8V~, 50Hz	elektromechaniczny electromechanical	IP20	czarny black	125 / 155 / 40

Główne cechy / Main features



Uszlachetniona, głęboka barwa dźwięku
Refined, deep sound



2 tony BIM-BAM
Two BIM-BAM ringtones



Dwa warianty zasilania
Two power variants

Warianty produktu / Available options



OR-DP-VD-144/W
OR-DP-VD-144/W/8V



OR-DP-VD-144/W-G
OR-DP-VD-144/W-G/8V



OR-DP-VD-144/B-G
OR-DP-VD-144/B-G/8V



TON COLOR

Dzwonek elektromechaniczny dwutonowy
Electromechanical two-tone doorbell

Symbol Product no.	EAN	Zasilanie Power supply	Typ Type	Stopień ochrony Protection rating	Kolor Color	Wymiary (szer./wys./gł. [mm]) Dimensions (W/H/D [mm])
OR-DP-VD-144/W	5900378654216	230V~, 50Hz	elektromechaniczny electromechanical	IP20	biały white	136 / 193 / 60
OR-DP-VD-144/W-G	5900378654230	230V~, 50Hz	elektromechaniczny electromechanical	IP20	biało-srebrny silver-white	136 / 193 / 60
OR-DP-VD-144/B-G	5900378654247	230V~, 50Hz	elektromechaniczny electromechanical	IP20	czarno-srebrny silver-black	136 / 193 / 60
OR-DP-VD-144/W/8V	5900378654254	8V~, 50Hz	elektromechaniczny electromechanical	IP20	biały white	136 / 193 / 60
OR-DP-VD-144/W-G/8V	5900378654278	8V~, 50Hz	elektromechaniczny electromechanical	IP20	biało-srebrny silver-white	136 / 193 / 60
OR-DP-VD-144/B-G/8V	5900378654285	8V~, 50Hz	elektromechaniczny electromechanical	IP20	czarno-srebrny silver-black	136 / 193 / 60



BELIS

Dzwonek elektromechaniczny dwutonowy
z wbudowanym transformatorem

Electromechanical two-tone doorbell
with built-in transformer

Główne cechy / Main features

Wbudowany transformator 8V
Built-in 8V transformer



2 tony BIM-BAM
Two BIM-BAM ringtones



Symbol Product no.	EAN	Zasilanie Power supply	Typ Type	Stopień ochrony Protection rating	Kolor Color	Wymiary (szer./wys./gt. [mm]) Dimensions (W/H/D [mm])
OR-DP-BD-157	5908254810268	230V~, 50Hz	elektromechaniczny electromechanical	IP20	biały white	106 / 170 / 50

Dzwonek szkolny
Alarm bell

Główne cechy / Main features

Lakierowana na czerwono stalowa czasza
Red-lacquered steel housing

Warianty produktu / Available options

Symbol Product no.	EAN	Zasilanie Power supply	Typ Type	Stopień ochrony Protection rating	Kolor Color	Wymiary (szer./wys./gł. [mm]) Dimensions (W/H/D [mm])
OR-DP-ML-131	5902560324082	230V~, 50Hz	elektromechaniczny electromechanical	IP44	czerwony red	Ø150 / 58

Dzwonek przewodowy na szynę DIN-1 moduł
Wired doorbell for DIN rail, single-track

Główne cechy / Main features

Montowany na szynie DIN
Mounted on a DIN rail

Warianty produktu / Available options

Symbol Product no.	EAN	Zasilanie Power supply	Typ Type	Stopień ochrony Protection rating	Kolor Color	Wymiary (szer./wys./gł. [mm]) Dimensions (W/H/D [mm])
OR-DP-SB-133	5902560329582	230V~, 50Hz	elektromechaniczny electromechanical	IP20	biały white	18 / 79 / 67

Przycisk dzwonekowy przewodowy
Wired doorbell button

Główne cechy / Main features

Miejsce na nazwisko
Nameplate

Warianty produktu / Available options

Symbol Product no.	EAN	Zasilanie Power supply	Typ Type	Stopień ochrony Protection rating	Kolor Color	Wymiary (szer./wys./gł. [mm]) Dimensions (W/H/D [mm])
OR-DP-VD-138PD1	5900378655350	z instalacji dzwonekowej from the doorbell installation	-	IP44	biały white	80 / 35 / 15

DZWONKI BEZPRZEWODOWE

WIRELESS DOORBELLS



LONGA AC

Dzwonek bezprzewodowy, sieciowy z funkcją learning system

Wireless doorbell, 230V with learning system

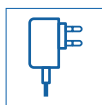

Zasilanie sieciowe
Mains powered



Regulacja głośności
Volume adjustment



Możliwość rozbudowy
Possibility of extension



Wymiary (szer./wys./gl. [mm]):
Odbiornik: 54 / 115 / 66, Nadajnik: 29 / 78 / 17,5
Dimensions (W/H/D [mm]):
Receiver: 54 / 115 / 66, Transmitter: 29 / 78 / 17,5



36 dźwięków dzwonka
36 ringtones



Wodoodporny przycisk
Weatherproof button



Funkcja learning system
Learning system

Symbol Product no.	EAN	Zasilanie (odbiornik) Power supply (receiver)	Zasilanie (nadajnik) Power supply (transmitter)	Zasięg Range	Stopień ochrony Protection rating	Kolor Color
OR-DB-QX-155	5908254805141	230V~, 50Hz	1xCR2032 (3V)	300m	IP44	biały white

DISCO DC

Dzwonek bezprzewodowy, bateryjny z funkcją learning system
Wireless, battery powered doorbell with learning system



Zasilanie bateryjne
Battery powered



Regulacja głośności
Volume adjustment



Wodoodporny przycisk
Weatherproof button



Możliwość rozbudowy
Possibility of extension



Funkcja learning system
Learning system



Wymiary (szer./wys./gt. [mm]):
Odbiornik: 60 / 120 / 32, Nadajnik: 45 / 103 / 20
Dimensions (W/H/D [mm]):
Receiver: 60 / 120 / 32, Transmitter: 45 / 103 / 20



Symbol Product no.	EAN	Zasilanie (odbiornik) Power supply (receiver)	Zasilanie (nadajnik) Power supply (transmitter)	Zasięg Range	Stopień ochrony Protection rating	Kolor Color
OR-DB-KH-122	5901752486973	3 x AA (4,5V)	1 x CR2032 (3V)	80m	IP44	biały white

DISCO AC

Dzwonek bezprzewodowy, sieciowy z funkcją learning system
Wireless doorbell, 230V with learning system

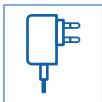

Zasilanie sieciowe
Mains powered



Wodoodporny przycisk
Weatherproof button



Możliwość rozbudowy
Possibility of extension



Funkcja learning system
Learning system



Wymiary (szer./wys./gt. [mm]):
Odbiornik: 75 / 120 / 65, Nadajnik: 45 / 103 / 20
Dimensions (W/H/D [mm]):
Receiver: 75 / 120 / 65, Transmitter: 45 / 103 / 20



Symbol Product no.	EAN	Zasilanie (odbiornik) Power supply (receiver)	Zasilanie (nadajnik) Power supply (transmitter)	Zasięg Range	Stopień ochrony Protection rating	Kolor Color
OR-DB-KH-123	5901752486980	230V~, 50Hz	1 x CR2032 (3V)	80m	IP44	biały white

FADO DC

Dzwonek bezprzewodowy, bateryjny z funkcją learning system
Wireless, battery powered doorbell with learning system



Zasilanie bateryjne
Battery powered



Regulacja głośności
Volume adjustment



Wodoodporny przycisk
Weatherproof button



Możliwość rozbudowy
Possibility of extension



Funkcja learning system
Learning system



36 dźwięków dzwonka
36 ringtones



Wymiary (szer./wys./gł. [mm]):
Odbiornik: 67 / 102 / 27, Nadajnik: 36 / 88 / 16
Dimensions (W/H/D [mm]):
Receiver: 67 / 102 / 27, Transmitter: 36 / 88 / 16



Symbol Product no.	EAN	Zasilanie (odbiornik) Power supply (receiver)	Zasilanie (nadajnik) Power supply (transmitter)	Zasięg Range	Stopień ochrony Protection rating	Kolor Color
OR-DB-KF-134	5902560328417	2 x AA (3V)	1 x CR2032 (3V)	80m	IP44	biały white

FADO AC

Dzwonek bezprzewodowy, sieciowy z funkcją learning system
Wireless doorbell, 230V with learning system



Zasilanie sieciowe
Mains powered

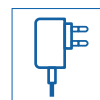

Regulacja głośności
Volume adjustment



Wodoodporny przycisk
Weatherproof button



Możliwość rozbudowy
Possibility of extension



Funkcja learning system
Learning system



36 dźwięków dzwonka
36 ringtones



Wymiary (szer./wys./gł. [mm]):
Odbiornik: 64,2 / 102 / 66, Nadajnik: 36 / 88 / 16
Dimensions (W/H/D [mm]):
Receiver: 64,2 / 102 / 66, Transmitter: 36 / 88 / 16



Symbol Product no.	EAN	Zasilanie (odbiornik) Power supply (receiver)	Zasilanie (nadajnik) Power supply (transmitter)	Zasięg Range	Stopień ochrony Protection rating	Kolor Color
OR-DB-KF-135	5902560328400	230V~, 50Hz	1 x CR2032 (3V)	80m	IP44	biały white

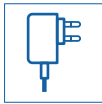

Zasilanie sieciowe
Mains powered

ERATO AC

Dzwonek bezprzewodowy, sieciowy z funkcją learning system
Wireless doorbell, 230V with learning system



Regulacja głośności
Volume adjustment



Wodoodporny przycisk
Weatherproof button



Możliwość rozbudowy
Possibility of extension



Funkcja learning system
Learning system



32 dźwięki dzwonka
32 ringtones



Wymiary (szer./wys./gł. [mm]):
Odbiornik: 71 / 98 / 58, Nadajnik: 37 / 90 / 26
Dimensions (W/H/D [mm]):
Receiver: 71 / 98 / 58, Transmitter: 37 / 90 / 26



Symbol Product no.	EAN	Zasilanie (odbiornik) Power supply (receiver)	Zasilanie (nadajnik) Power supply (transmitter)	Zasięg Range	Stopień ochrony Protection rating	Kolor Color
OR-DB-AX-151	5900378654391	230V~, 50Hz	1 x CR2032 (3V)	100m	IP44	biały white



Zasilanie bateryjne
Battery powered

OPERA DC

Dzwonek bezprzewodowy, bateryjny z funkcją learning system
Wireless, battery powered doorbell with learning system



Regulacja głośności
Volume adjustment



Wodoodporny przycisk
Weatherproof button



Możliwość rozbudowy
Possibility of extension



Funkcja learning system
Learning system



36 dźwięków dzwonka
36 ringtones



Wymiary (szer./wys./gł. [mm]):
Odbiornik: 78 / 86 / 34, Nadajnik: 40 / 86 / 20
Dimensions (W/H/D [mm]):
Receiver: 78 / 86 / 34, Transmitter: 40 / 86 / 20



Symbol Product no.	EAN	Zasilanie (odbiornik) Power supply (receiver)	Zasilanie (nadajnik) Power supply (transmitter)	Zasięg Range	Stopień ochrony Protection rating	Kolor Color
OR-DB-YK-118	5901752484139	3 x AAA (4,5V)	1 x 23A (12V)	100m	IP44	czarny black

OPERA AC

Dzwonek bezprzewodowy, sieciowy z funkcją learning system
Wireless doorbell, 230V with learning system



Zasilanie sieciowe
Mains powered

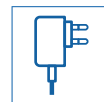

Regulacja głośności
Volume adjustment



Wodoodporny przycisk
Weatherproof button



Możliwość rozbudowy
Possibility of extension



Funkcja learning system
Learning system



36 dźwięki dzwonka
36 ringtones



Wymiary (szer./wys./gt. [mm]):
Odbiornik: 70 / 105 / 75, Nadajnik: 40 / 86 / 20
Dimensions (W/H/D [mm]):
Receiver: 70 / 105 / 75, Transmitter: 40 / 86 / 20



Symbol Product no.	EAN	Zasilanie (odbiornik) Power supply (receiver)	Zasilanie (nadajnik) Power supply (transmitter)	Zasięg Range	Stopień ochrony Protection rating	Kolor Color
OR-DB-YK-117	5901752484146	230V~, 50Hz	1 x 23A (12V)	100m	IP44	czarny black

CALYPSO II DC

Dzwonek bezprzewodowy, bateryjny z funkcją learning system
Wireless, battery powered doorbell with learning system



Zasilanie bateryjne
Battery powered



Regulacja głośności
Volume adjustment



Wodoodporny przycisk
Weatherproof button



Możliwość rozbudowy
Possibility of extension



Funkcja learning system
Learning system



36 dźwięki dzwonka
36 ringtones



Wymiary (szer./wys./gt. [mm]):
Odbiornik: 75 / 110 / 34, Nadajnik: 32 / 80 / 22
Dimensions (W/H/D [mm]):
Receiver: 75 / 110 / 34, Transmitter: 32 / 80 / 22



Symbol Product no.	EAN	Zasilanie (odbiornik) Power supply (receiver)	Zasilanie (nadajnik) Power supply (transmitter)	Zasięg Range	Stopień ochrony Protection rating	Kolor Color
OR-DB-QS-158	5908254813160	2 x AA (3V)	1 x CR2032 (3V)	300m	IP44	czarny black

CALYPSO II AC

Dzwonek bezprzewodowy, sieciowy z funkcją learning system
Wireless doorbell, 230V with learning system

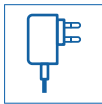

Zasilanie sieciowe
Mains powered



Regulacja głośności
Volume adjustment



Wodoodporny przycisk
Weatherproof button



Możliwość rozbudowy
Possibility of extension



Funkcja learning system
Learning system



36 dźwięków dzwonka
36 ringtones



Wymiary (szer./wys./gł. [mm]):
Odbiornik: 75 / 110 / 65, Nadajnik: 32 / 80 / 22
Dimensions (W/H/D [mm]):
Receiver: 75 / 110 / 65, Transmitter: 32 / 80 / 22



Symbol Product no.	EAN	Zasilanie (odbiornik) Power supply (receiver)	Zasilanie (nadajnik) Power supply (transmitter)	Zasięg Range	Stopień ochrony Protection rating	Kolor Color
OR-DB-QS-159	5908254813177	230V~, 50Hz	1 x CR2032 (3V)	300m	IP44	czarny black

TORINO II DC

Dzwonek bezprzewodowy, baterijny z funkcją learning system
Wireless, battery powered doorbell with learning system



Zasilanie bateryjne
Battery powered



Regulacja głośności
Volume adjustment



Wodoodporny przycisk
Weatherproof button



Możliwość rozbudowy
Possibility of extension



Funkcja learning system
Learning system



58 dźwięków dzwonka
58 ringtones



Wymiary (szer./wys./gł. [mm]):
Odbiornik: 80 / 80 / 25, Nadajnik: 30 / 85 / 18
Dimensions (W/H/D [mm]):
Receiver: 80 / 80 / 25, Transmitter: 30 / 85 / 18



Symbol Product no.	EAN	Zasilanie (odbiornik) Power supply (receiver)	Zasilanie (nadajnik) Power supply (transmitter)	Zasięg Range	Stopień ochrony Protection rating	Kolor Color
OR-DB-FX-152	5908254803390	3 x AAA (4,5V)	2 x CR2016 (6V)	400m	IP44	biały white

TORINO II AC

Dzwonek bezprzewodowy, sieciowy z funkcją learning system
Wireless doorbell, 230V with learning system



Zasilanie sieciowe
Mains powered

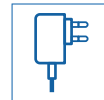

Regulacja głośności
Volume adjustment



Wodoodporny przycisk
Weatherproof button



Możliwość rozbudowy
Possibility of extension



Funkcja learning system
Learning system



58 dźwięków dzwonka
58 ringtones



Wymiary (szer./wys./gt. [mm]):
Odbiornik: Ø85 / 65, Nadajnik: 30 / 85 / 18
Dimensions (W/H/D [mm]):
Receiver: Ø85 / 65, Transmitter: 30 / 85 / 18



Symbol Product no.	EAN	Zasilanie (odbiornik) Power supply (receiver)	Zasilanie (nadajnik) Power supply (transmitter)	Zasięg Range	Stopień ochrony Protection rating	Kolor Color
OR-DB-FX-153	5908254803406	230V~, 50Hz	2 x CR2016 (6V)	400m	IP44	biały white

ONDO AC

Dzwonek bezprzewodowy, sieciowy z funkcją learning system
Wireless doorbell, 230V with learning system



Zasilanie sieciowe
Mains powered

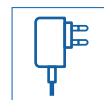

Regulacja głośności
Volume adjustment



Wodoodporny przycisk
Weatherproof button



Możliwość rozbudowy
Possibility of extension



Funkcja learning system
Learning system



36 dźwięków dzwonka
36 ringtones



Wymiary (szer./wys./gt. [mm]):
Odbiornik: 81 / 81 / 35, Nadajnik: 50 / 82 / 21,5
Dimensions (W/H/D [mm]):
Receiver: 81 / 81 / 35, Transmitter: 50 / 82 / 21,5



 Bezbaterijny przycisk
Battery-free button

Symbol Product no.	EAN	Zasilanie (odbiornik) Power supply (receiver)	Zasilanie (nadajnik) Power supply (transmitter)	Zasięg Range	Stopień ochrony Protection rating	Kolor Color
OR-DB-MT-156	5908254805721	230V~, 50Hz	bezbaterijny battery-free	200m	IP44	czarny black

ONDO 2 AC

Dzwonek bezprzewodowy z 2 odbiornikami sieciowymi i funkcją learning system

Wireless doorbell with two mains powered receivers and learning system

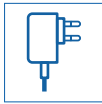
Zasilanie sieciowe
Mains poweredRegulacja głośności
Volume adjustmentWodoodporny przycisk
Weatherproof buttonMożliwość rozbudowy
Possibility of extensionFunkcja learning system
Learning system36 dźwięki dzwonka
36 ringtonesWymiary (szer./wys./gt. [mm]):
Odbiornik: 81 / 81 / 35, Nadajnik: 50 / 82 / 21,5
Dimensions (W/H/D [mm]):
Receiver: 81 / 81 / 35, Transmitter: 50 / 82 / 21,5Bezbateryjny przycisk
Battery-free button

Symbol Product no.	EAN	Zasilanie (odbiornik) Power supply (receiver)	Zasilanie (nadajnik) Power supply (transmitter)	Zasięg Range	Stopień ochrony Protection rating	Kolor Color
OR-DB-MT-165	5908254820205	230V~, 50Hz	bezbateryjny battery-free	200m	IP44	czarny black

MOŻLIWOŚCI ROZBUDOWY Z WYKORZYSTANIEM LEARNING SYSTEM

POSSIBILITY OF EXTENSION WITH THE LEARNING SYSTEM FUNCTION







TABELA PORÓWNAWCZA
DZWONKI **BEZPRZEWODOWE**

COMPARISON TABLE
WIRELESS DOORBELLS

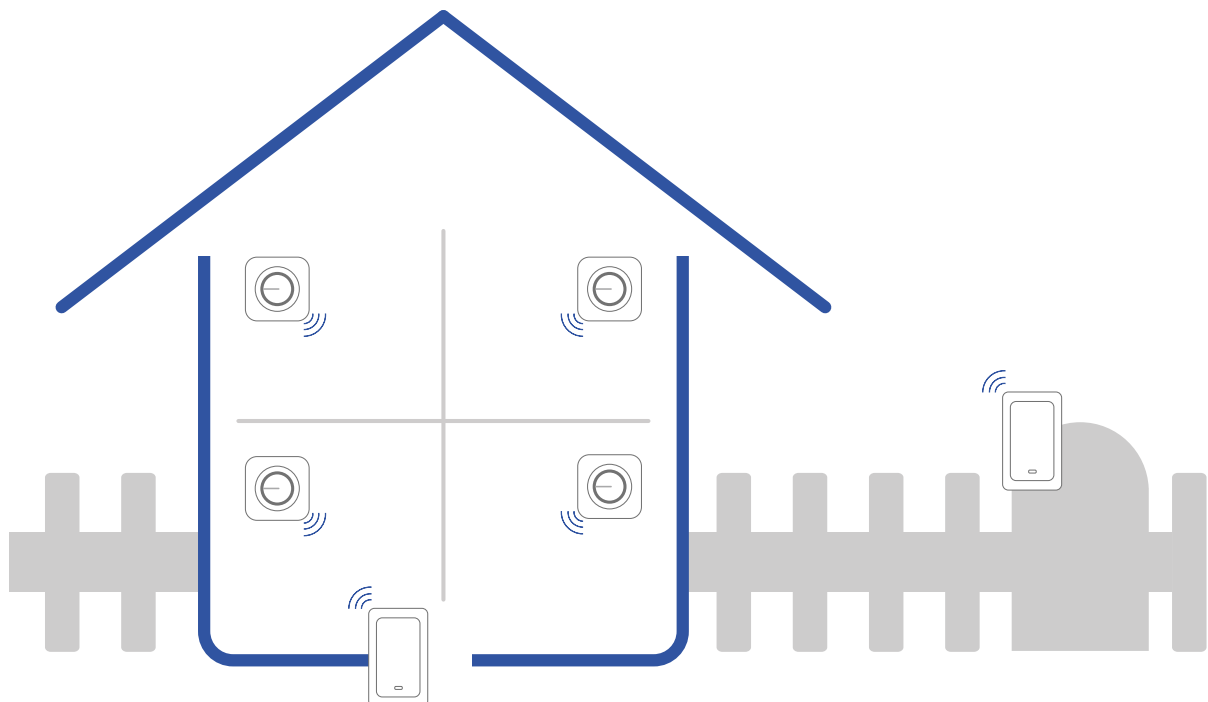
				
Model Product no.	OR-DB-KH-122	OR-DB-KH-123	OR-DB-KF-134	OR-DB-KF-135
EAN	5901752486973	5901752486980	5902560328417	5902560328400
Zasięg w terenie otwartym Range in the open area	80m	80m	80m	80m
Kolor Color	biały white	biały white	biały white	biały white
Możliwość rozbudowy o dodatkowe nadajniki Possibility of extension by additional transmitters	✓	✓	✓	✓
Inne cechy Other features	learning system	learning system	learning system	learning system
ODBIORNIK / Receiver				
Napięcie zasilania odbiornika Power supply of the receiver	4,5V (3 x AA)	230V~, 50Hz	3V (2 x AA)	230V~, 50Hz
Rodzaj zasilania odbiornika Type of power supply of the receiver	bateryjne battery	sieciowe mains supply (230V)	bateryjne battery	sieciowe mains supply (230V)
Bateria w zestawie Battery included	✗	✗	✗	✗
Ilość dźwięków dzwonka Number of ringtones	1	1	36	36
Poziom głośności dzwonka (dB) Doorbell volume (db)	60-80	80	69-89	69-89
Regulacja głośności Volume adjustment	✓	✗	✓	✓
Sygnalizacja optyczna Optical indication	✗	✓	✗	✗
Wymiary odbiornika (szer./wys./gt. [mm]) Dimensions of the receiver (W / H / D [mm])	60 / 120 / 32	75 / 120 / 65	67 / 102 / 27	64,2 / 102 / 66
NADAJNIK / TRANSMITTER				
Napięcie zasilania nadajnika Power supply of the transmitter	3V (1xCR2032)	3V (1xCR2032)	3V (1xCR2032)	3V (1xCR2032)
Rodzaj zasilania nadajnika Type of power supply of the transmitter	bateryjne battery	bateryjne battery	bateryjne battery	bateryjne battery
Baterie w zestawie (nadajnik) Battery included (transmitter)	✓	✓	✓	✓
Stopień ochrony Protection rating	IP44	IP44	IP44	IP44
Wymiary nadajnika (szer./wys./gt. [mm]) Dimensions of the transmitter (W / H / D [mm])	45 / 103 / 20	45 / 103 / 20	36 / 88 / 16	36 / 88 / 16
Częstotliwość Frequency	433.92MHz	433.92MHz	433.92MHz	433.92MHz
Inne cechy Other features	✗	✗	✗	✗

					
OR-DB-AX-151	OR-DB-YK-118	OR-DB-YK-117	OR-DB-QS-158	OR-DB-QS-159	OR-DB-QX-155
5900378654391	5901752484139	5901752484146	5908254813160	5908254813177	5908254805141
100 m	100m	100m	300m	300m	300m
biały white	czarny black	czarny black	czarny black	czarny black	biały white
✓	✓	✓	✓	✓	✓
learning system	learning system	learning system	learning system	learning system	learning system
230V~, 50Hz	4,5V (3 x AAA)	230V~, 50Hz	3V (2 x AA)	230V~, 50Hz	230V~, 50Hz
sieciowe mains supply (230V)	baterijne battery	sieciowe mains supply (230V)	baterijne battery	sieciowe mains supply (230V)	sieciowe mains supply (230V)
✗	✗	✗	✗	✗	✗
32	36	36	36	36	36
50-80	50-90	50-90	65-85	65-85	60-80
✓	✓	✓	✓	✓	✓
✓	✓	✓	✓	✓	✗
71 / 98 / 58	78 / 86 / 34	70 / 105 / 75	75 / 110 / 34	75 / 110 / 65	54 / 115 / 66
3V (1xCR2032)	12V (1 x 23A)	12V (1 x 23A)	3V (1xCR2032)	3V (1xCR2032)	3V (1xCR2032)
baterijne battery	baterijne battery	baterijne battery	baterijne battery	baterijne battery	baterijne via battery
✓	✓	✓	✓	✓	✓
IP44	IP44	IP44	IP44	IP44	IP44
37 / 90 / 26	40 / 86 / 20	40 / 86 / 20	32 / 80 / 22	32 / 80 / 22	29 / 78 / 17,5
433.92MHz	433.92MHz	433.92MHz	433.92MHz	433.92MHz	433.92MHz
✗	✗	✗	✗	✗	✗

			
OR-DB-FX-152	OR-DB-FX-153	OR-DB-MT-156	OR-DB-MT-165
5908254803390	5908254803406	5908254805721	5908254820205
400m	400m	200m	200m
biały white	biały white	czarny black	czarny black
✓	✓	✓	✓
learning system	learning system	learning system	learning system
4,5V (3 x AAA)	230V~, 50Hz	230V~, 50Hz	230V~, 50Hz
baterijne via battery	sieciowe mains supply (230V)	sieciowe mains supply (230V)	sieciowe mains supply (230V)
✗	✗	✗	✗
58	58	36	36
0-110	0-110	60-90	60-90
✓	✓	✓	✓
✓	✓	✓	✓
80 / 80 / 25	O85 / 65	81 / 81 / 35	81 / 81 / 35
6V (2 x CR2016)	6V (2 x CR2016)	-	-
baterijne via battery	baterijne via battery	bezbaterijne electromechanical transducer - battery is not required	bezbaterijne electromechanical transducer - battery is not required
✓	✓	✗	✗
IP44	IP44	IP44	IP44
30 / 85 / 18	30 / 85 / 18	50 / 82 / 21,5	50 / 82 / 21,5
433.92MHz	433.92MHz	433.92MHz	433.92MHz
✗	✗	✗	✗

DOMOFONY

DOORPHONES



AVIOR

Zestaw domofonowy jednorodzinny z interkomem i czytnikiem breloków zbliżeniowych

Single family doorphone with intercom and proximity tags reader

Główne cechy / Main features

- 

Sterowanie bramą
Gate opening
- 

Możliwość rozbudowy o dodatkowy unifon
Possibility of extension by an additional indoor unit
- 

Możliwość rozbudowy o dodatkowy panel zewnętrzny
Possibility of extension by an additional outdoor unit
- 

Funkcja interkomu
Intercom function
- 

Regulacja głośności
Volume adjustment
- 

Czytnik zbliżeniowy
Proximity tags reader

Warianty produktu / Available options



OR-DOM-JA-928/W

OR-DOM-JA-928/B

Symbol Product no.	EAN	System łączenia Connection system	Kolor Color	Unifon (szer./wys./gl. [mm]) Indoor unit (W/H/D [mm])	Panel zew. (szer./wys./gl. [mm]) Outdoor unit (W/H/D [mm])
OR-DOM-JA-928/W	5908254800627	3-żyłowy 3-wire	biały white	82 / 180 / 40	43,2 / 140,6 / 29,3
OR-DOM-JA-928/B	5908254803659	3-żyłowy 3-wire	czarny black	82 / 180 / 40	43,2 / 140,6 / 29,3

FOSSA

Główne cechy / Main features



Dodatkowe podświetlenie nazwiska
Nameplate with additional backlight



Możliwość rozbudowy o dodatkowy unifon
Possibility of extension by an additional indoor unit



Montaż natynkowy przy zastosowaniu daszka (brak w zestawie)
Surface mounting only with protective rain cover (not included)



OR-DOM-RL-901DN/G
OR-DOM-RL-901DN/B

Daszek ochronny, natynkowy

Protective rain cover, surface mounted

Zestaw domofonowy jednorodzinny, podtynkowy
Single family doorphone, flush mounted

Symbol Product no.	EAN	System łączenia Connection system	Kolor Color	Unifon (szer./wys./gt. [mm]) Indoor unit (W/H/D [mm])	Panel zew. (szer./wys./gt. [mm]) Outdoor unit (W/H/D [mm])
OR-DOM-RL-901	5908235905242	4-żyłowy 4-wire	biały white	98 / 215 / 68	116 / 200 / 54

ENSIS

Zestaw domofonowy jednorodzinny, wandaloodporny
Single family doorphone, vandal proof

Główne cechy / Main features



Możliwość rozbudowy o dodatkowy unifon
Possibility of extension by an additional indoor unit



Symbol Product no.	EAN	System łączenia Connection system	Kolor Color	Unifon (szer./wys./gt. [mm]) Indoor unit (W/H/D [mm])	Panel zew. (szer./wys./gt. [mm]) Outdoor unit (W/H/D [mm])
OR-DOM-RL-913	5901752481664	4-żyłowy 4-wire	biały white	98 / 215 / 68	60 / 140 / 23

ELUVIO

Zestaw domofonowy jednorodzinny, bezsłuchawkowy
Single family doorphone, handset free

Główne cechy / Main features



Sterowanie bramą
Gate opening



Regulacja głośności
Volume adjustment



Warianty produktu / Available options



OR-DOM-RE-914/W



OR-DOM-RE-914/B



OR-DOM-RE-914/G

Symbol Product no.	EAN	System łączenia Connection system	Kolor Color	Unifon (szer./wys./gł. [mm]) Indoor unit (W/H/D [mm])	Panelzew. (szer./wys./gł. [mm]) Outdoor unit (W/H/D [mm])
OR-DOM-RE-914/W	5901752481824	4-żyłowy 4-wire	biały white	90 / 137 / 26	56 / 124 / 41,5
OR-DOM-RE-914/B	5901752483903	4-żyłowy 4-wire	czarny black	90 / 137 / 26	56 / 124 / 41,5
OR-DOM-RE-914/G	5901752483910	4-żyłowy 4-wire	szary grey	90 / 137 / 26	56 / 124 / 41,5

MIZAR

Zestaw domofonowy jednorodzinny, natynkowy z czytnikiem breloków
Single family doorphone, surface mounted with proximity tags reader

Główne cechy / Main features



Sterowanie bramą
Gate opening



Możliwość rozbudowy o dodatkowy unifon
Possibility of extension by an additional indoor unit



Funkcja interkomu
Intercom function



Regulacja głośności
Volume adjustment



Czytnik zbliżeniowy
Proximity tags reader



Dodatkowe podświetlenie nazwiska
Nameplate with additional backlight



Symbol Product no.	EAN	System łączenia Connection system	Kolor Color	Unifon (szer./wys./gł. [mm]) Indoor unit (W/H/D [mm])	Panelzew. (szer./wys./gł. [mm]) Outdoor unit (W/H/D [mm])
OR-DOM-AT-929/W	5908254804090	3-żyłowy 3-wire	biały white	82 / 180 / 40	74,5 / 165 / 40

Główne cechy / Main features



Funkcja interkomu
Intercom function



Miejsce na nazwisko
Nameplate



Dodatkowe podświetlenie nazwiska
Nameplate with additional backlight



Montaż natynkowy przy zastosowaniu daszka (brak w zestawie)
Surface mounting only with protective rain cover (not included)



OR-DOM-RL-901DN/G
OR-DOM-RL-901DN/B

Daszek ochronny, natynkowy

Protective rain cover, surface mounted

Symbol Product no.	EAN	System łączenia Connection system	Kolor Color	Unifon (szer./wys./gł. [mm]) Indoor unit (W/H/D [mm])	Panel zew. (szer./wys./gł. [mm]) Outdoor unit (W/H/D [mm])
OR-DOM-RL-902	5908235905297	4-żyłowy 4-wire	biały white	98 / 215 / 68	116 / 200 / 54

FOSSA INTERCOM

Zestaw domofonowy jednorodzinny z interkodem, podtynkowy
Single family doorphone with intercom, flush mounted



Główne cechy / Main features



Sterowanie bramą
Gate opening



Regulacja głośności
Volume adjustment



Funkcja interkomu
Intercom function

Warianty produktu / Available options



OR-DOM-RE-920/W



OR-DOM-RE-920/B



OR-DOM-RE-920/G



ELUVIO INTERCOM

Zestaw domofonowy jednorodzinny z interkodem, bezsłuchawkowy
Single family doorphone with intercom, handset free

Symbol Product no.	EAN	System łączenia Connection system	Kolor Color	Unifon (szer./wys./gł. [mm]) Indoor unit (W/H/D [mm])	Panel zew. (szer./wys./gł. [mm]) Outdoor unit (W/H/D [mm])
OR-DOM-RE-920/W	5901752484511	4-żyłowy 4-wire	biały white	90 / 137 / 26	56 / 124 / 41,5
OR-DOM-RE-920/B	5901752484528	4-żyłowy 4-wire	czarny black	90 / 137 / 26	56 / 124 / 41,5
OR-DOM-RE-920/G	5901752484535	4-żyłowy 4-wire	szary grey	90 / 137 / 26	56 / 124 / 41,5

FOSSA MULTI

Zestaw domofonowy 2-rodzinny, podtynkowy
Two family doorphone, flush mounted



Główne cechy / Main features

Możliwość rozbudowy o dodatkowy unifon
Possibility of extension by additional indoor unit



Dodatkowe podświetlenie nazwiska
Nameplate with additional backlight



OR-DOM-RL-901DN/G
OR-DOM-RL-901DN/B

Daszek ochronny, natynkowy
Protective rain cover, surface mounted

Symbol Product no.	EAN	System łączenia Connection system	Kolor Color	Unifon (szer./wys./gt. [mm]) Indoor unit (W/H/D [mm])	Panelzew. (szer./wys./gt. [mm]) Outdoor unit (W/H/D [mm])
OR-DOM-RL-903	5908235905303	4-żyłowy 4-wire	biały white	98 / 215 / 68	116 / 200 / 54

MIZAR MULTI

Zestaw domofonowy 2-rodzinny z interkodem, natynkowy z czytnikiem breloków
Two family doorphone with intercom, surface mounted with proximity tags reader



Główne cechy / Main features

Sterowanie bramą
Gate opening



Możliwość rozbudowy o dodatkowe unifony
Possibility of extension by additional indoor units



Czytnik zbliżeniowy
Proximity tags reader



Funkcja interkodu
Intercom function



Regulacja głośności
Volume adjustment



Dodatkowe podświetlenie nazwiska
Nameplate with additional backlight



Symbol Product no.	EAN	System łączenia Connection system	Kolor Color	Unifon (szer./wys./gt. [mm]) Indoor unit (W/H/D [mm])	Panelzew. (szer./wys./gt. [mm]) Outdoor unit (W/H/D [mm])
OR-DOM-AT-930/W	5908254804250	3-żyłowy 3-wire	biały white	82 / 180 / 40	74,5 / 165 / 40



vibell
PROFESSIONAL SYSTEMS



SAGITTA

Zestaw domofonowy jednorodzinny, natynkowy
Single family doorphone, surface mounted

Główne cechy / Main features

Sterowanie bramą
Gate opening



Dodatkowe podświetlenie nazwiska
Nameplate with additional backlight



2-żyłowy system łączenia
2-wire connection system



Możliwość rozbudowy o dodatkowe unifony
Possibility of extension by additional indoor units



Funkcja interkomu
Intercom function



Symbol Product no.	EAN	System łączenia Connection system	Kolor Color	Unifon (szer./wys./gł. [mm]) Indoor unit (W/H/D [mm])	Panel zew. (szer./wys./gł. [mm]) Outdoor unit (W/H/D [mm])
OR-DOM-SG-918	5901752484085	2-żyłowy 2-wire	biały white	70 / 210 / 40	95 / 120 / 30



SALEM

Zestaw domofonowy jednorodzinny, natynkowy
Single family doorphone, surface mounted



vibell
PROFESSIONAL SYSTEMS

Główne cechy / Main features

Sterowanie bramą
Gate opening



Możliwość rozbudowy o dodatkowe unifony
Possibility of extension by additional indoor units



Funkcja interkomu
Intercom function



Dodatkowe podświetlenie nazwiska
Nameplate with additional backlight



Słuchawka magnetyczna
Magnetic handset



Regulacja głośności
Volume adjustment



2-żyłowy system łączenia
2-wire connection system



Symbol Product no.	EAN	System łączenia Connection system	Kolor Color	Unifon (szer./wys./gł. [mm]) Indoor unit (W/H/D [mm])	Panelzew. (szer./wys./gł. [mm]) Outdoor unit (W/H/D [mm])
OR-DOM-SL-923	5901752486744	2-żyłowy 2-wire	biały white	105 / 210 / 26	90 / 135 / 30



SAGITTA MULTI

Zestaw domofonowy 2-rodzinny, natynkowy
Two family doorphone, surface mounted



vibell
PROFESSIONAL SYSTEMS

Główne cechy / Main features

Sterowanie bramą
Gate opening



Możliwość rozbudowy o dodatkowe unifony
Possibility of extension by additional indoor units



Funkcja interkomu
Intercom function



Dodatkowe podświetlenie nazwiska
Nameplate with additional backlight



2-żyłowy system łączenia
2-wire connection system



Symbol Product no.	EAN	System łączenia Connection system	Kolor Color	Unifon (szer./wys./gł. [mm]) Indoor unit (W/H/D [mm])	Panelzew. (szer./wys./gł. [mm]) Outdoor unit (W/H/D [mm])
OR-DOM-SG-919	5901752484092	2-żyłowy 2-wire	biały white	70 / 210 / 40	95 / 180 / 30

Główne cechy / Main features

-  Sterowanie bramą
Gate opening
-  Możliwość rozbudowy o dodatkowe unifony
Possibility of extension by additional indoor units
-  Funkcja interkomu
Intercom function
-  Dodatkowe podświetlenie nazwiska
Nameplate with additional backlight
-  Słuchawka magnetyczna
Magnetic handset
-  Regulacja głośności
Volume adjustment
-  2-żyłowy system łączenia
2-wire connection system

SALEM MULTI

Zestaw domofonowy 2-rodzinny, natynkowy
Two family doorphone, surface mounted



vibell
PROFESSIONAL SYSTEMS

Symbol Product no.	EAN	System łączenia Connection system	Kolor Color	Unifon (szer./wys./gł. [mm]) Indoor unit (W/H/D [mm])	Panelzew. (szer./wys./gł. [mm]) Outdoor unit (W/H/D [mm])
OR-DOM-SL-924	5901752486751	2-żyłowy 2-wire	biały white	105 / 210 / 26	90 / 135 / 30

PRZYKŁADOWE SCHEMATY PODŁĄCZENIA DOMOFONÓW

EXAMPLES OF DOORPHONE CONNECTION DIAGRAMS

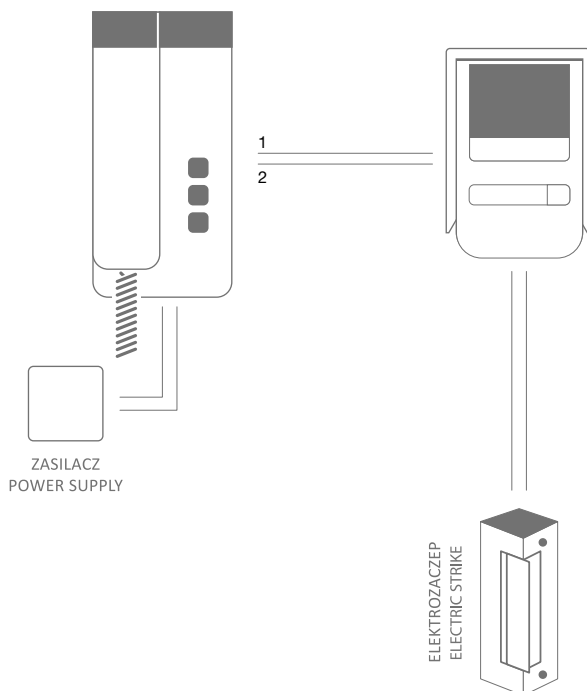

System 2-żyłowy / System łączenia elektrozaczepu z panelem zewnętrznym
2-wire system / Connection system between the electric strike and an external panel

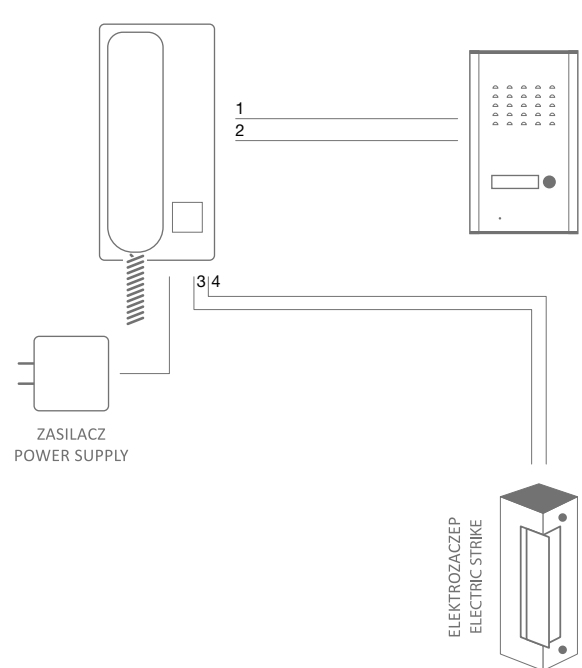



System 4-żyłowy / System łączenia elektrozaczepu z unifonem
4-wire system / Connection system between the electric strike and a handset unit





TABELA PORÓWNAWCZA
DOMOFONY

COMPARISON TABLE
DOORPHONES

Zestawy domofonowe jednorodzinne

SINGLE-FAMILY DOORPHONES

			
Model Product no.	OR-DOM-RL-901	OR-DOM-RL-913	OR-DOM-RE-914/W OR-DOM-RE-914/B OR-DOM-RE-914/G
EAN	5908235905242	5901752481664	5901752481824 5901752483903 5901752483910
Typ Type	jednorodzinny single-family	jednorodzinny single-family	jednorodzinny single-family
Rodzaj transmisji Type of transmission	przewodowy wired	przewodowy wired	przewodowy wired
Rodzaj zasilania Type of power supply	bezpośrednio do 230V directly to 230V	bezpośrednio do 230V directly to 230V	zasilacz sieciowy plug-in power supply
System łączenia Connection system	4-żyłowy 4-wire	4-żyłowy 4-wire	4-żyłowy 4-wire
Ilość przewodów Number of wires	4	4	4+2
System łączenia elektrozaczepek System of the electrical lock connection	z unifonem with indoor unit	z unifonem with indoor unit	z panelem zewnętrznym with outdoor unit
Zasilanie elektrozaczepek Power supply of the electric strike	z domofonu from the doorphone	z domofonu from the doorphone	z domofonu from the doorphone
Sterowanie bramą automatyczną Control of the automatic gate	✗	✗	✓
Możliwość rozbudowy o dodatkowy unifon Possibility of extension by an additional indoor unit	✓	✓	✗
Możliwość rozbudowy o dodatkowy panel zewnętrzny Possibility of extension by an additional outdoor unit	✗	✗	✗
UNIFON / INDOOR UNIT			
Obsługa Operation	słuchawka via handset	słuchawka via handset	głośnomówiący via speakerphone
Regulacja głośności Volume adjustment	✗	✗	✓
Ilość dźwięków dzwonka Number of ringtones	1	1	1
Funkcja Interkomu Intercom function	✗	✗	✗
Kolor unifonu Color of the indoor unit	biały white	biały white	biały / white czarny / black szary / grey
Wymiary unifonu (szer./wys./gt. [mm]) Dimensions of the indoor unit (W / H / D [mm])	98 / 215 / 68	98 / 215 / 68	90 / 137 / 26
PANEL ZEWNĘTRZNY / OUTDOOR UNIT			
Montaż Installation	natynkowy / podtynkowy surface/flush mounted	natynkowy / podtynkowy surface/flush mounted	natynkowy surface mounted
Czytnik kart i breloków zbliżeniowych Card and proximity tags reader	✗	✗	✗
Wymiary (szer./wys./gt. [mm]) Dimensions (W / H / D [mm])	116 / 200 / 54	60 / 140 / 23	56 / 124 / 41,5
Inne cechy panelu Other features of the outdoor unit	podświetlane miejsce na nazwisko backlit nameplate	✗	✗

				
OR-DOM-JA-928/W OR-DOM-JA-928/B	OR-DOM-AT-929/W	OR-DOM-RL-902	OR-DOM-RE-920/W OR-DOM-RE-920/B OR-DOM-RE-920/G	OR-DOM-SG-918
5908254800627 5908254803659	5908254804090	5908235905297	5901752484511 5901752484528 5901752484535	5901752484085
jednorodzinny single-family	jednorodzinny single-family	jednorodzinny single-family	jednorodzinny single-family	jednorodzinny single-family
przewodowy wired	przewodowy wired	przewodowy wired	przewodowy wired	przewodowy wired
zasilacz sieciowy plug-in power supply	zasilacz sieciowy plug-in power supply	bezpośrednio do 230V directly to 230V	zasilacz sieciowy plug-in power supply	zasilacz na szynę DIN power supply for DIN rail
3-żyłowy 3-wire	3-żyłowy 3-wire	4-żyłowy (+8 między unifonami) 4-wire (+8 between indoor units)	4-żyłowy (+4 między unifonami) 4-wire (+4 between indoor units)	2-żyłowy 2-wire
3+2	3+2	4	4+2	2+2
z panelem zewnętrznym with outdoor unit	z panelem zewnętrznym with outdoor unit	z unifonem with indoor unit	z panelem zewnętrznym with outdoor unit	z panelem zewnętrznym with outdoor unit
z domofonu from the doorphone	z domofonu from the doorphone	z domofonu from the doorphone	z domofonu from the doorphone	z domofonu from the doorphone
✓	✓	✗	✓	✓
✓	✓	✗	✗	✓
✓	✗	✗	✗	✗
sluchawka via handset	sluchawka via handset	sluchawka via handset	głośnomówiący via speakerphone	sluchawka via handset
✓	✓	✗	✓	✓
1	1	1	1	1
✓	✓	✓	✓	✓
biały / white czarny / black	biały white	biały white	biały / white czarny / black szary / grey	biały white
82 / 180 / 39,9	83 / 180 / 41	98 / 215 / 68	90 / 137 / 26	70 / 210 / 40
natynkowy surface mounted	natynkowy surface mounted	natynkowy / podtynkowy surface/flush mounted	natynkowy surface mounted	natynkowy surface mounted
✓	✓	✗	✗	✗
43,2 / 140,6 / 29,3	74,5 / 165 / 40	116 / 200 / 54	56 / 124 / 41,5	95 / 120 / 30
✗	podświetlane miejsce na nazwisko backlit place for name	podświetlane miejsce na nazwisko backlit place for name	✗	podświetlane miejsce na nazwisko backlit place for name

Zestawy domofonowe dwurodzinne

TWO FAMILY DOORPHONES



OR-DOM-SL-923	OR-DOM-RL-903	OR-DOM-AT-930/W	OR-DOM-SG-919	OR-DOM-SL-924
5901752486744	5908235905303	5908254804250	5901752484092	5901752486751
jednorodzinny single-family	dwurodzinny two family	dwurodzinny two family	dwurodzinny two family	dwurodzinny two family
przewodowy wired	przewodowy wired	przewodowy wired	przewodowy wired	przewodowy wired
zasilacz na szynę DIN power supply for DIN rail	bezpośrednio do 230V directly to 230V	zasilacz sieciowy plug-in power supply	zasilacz na szynę DIN power supply for DIN rail	zasilacz na szynę DIN power supply for DIN rail
2-żyłowy 2-wire	4-żyłowy 4-wire	3-żyłowy 3-wire	2-żyłowy 2-wire	2-żyłowy 2-wire
2+2	4	3+2	2+2	2+2
z panelem zewnętrznym with outdoor unit	z unifonem with indoor unit	z panelem zewnętrznym with outdoor unit	z panelem zewnętrznym with outdoor unit	z panelem zewnętrznym with outdoor unit
z domofonu from the doorphone	z domofonu from the doorphone	z domofonu from the doorphone	z domofonu from the doorphone	z domofonu from the doorphone
✓	✗	✓	✓	✓
✓	✓	✓	✓	✓
✗	✗	✗	✗	✗
sluchawka magnetyczna via magnetic handset	sluchawka via handset	sluchawka via handset	sluchawka via handset	sluchawka magnetyczna via magnetic handset
✓	✗	✓	✓	✓
1	1	1	1	1
✓	✗	✓	✓	✓
biały white	biały white	biały white	biały white	biały white
105 / 210 / 26	98 / 215 / 68	83 / 180 / 41	70 / 210 / 40	105 / 210 / 26
natynkowy surface mounted	natynkowy / podtynkowy surface/flush mounted	natynkowy surface mounted	natynkowy surface mounted	natynkowy surface mounted
✗	✗	✓	✗	✗
90 / 135 / 30	116 / 200 / 54	74,5 / 165 / 40	95 / 180 / 30	90 / 135 / 30
podświetlane miejsce na nazwisko backlit place for name	podświetlane miejsce na nazwisko backlit place for name	podświetlane miejsce na nazwisko backlit place for name	podświetlane miejsce na nazwisko backlit place for name	podświetlane miejsce na nazwisko backlit place for name



WIDEODOMOFONY

VIDEODOORPHONES

APPOS

Zestaw wideodomofonowy jednorodzinny z WIFI, 2-żyłowy
Single family videodoorphone set with WIFI, 2-wire

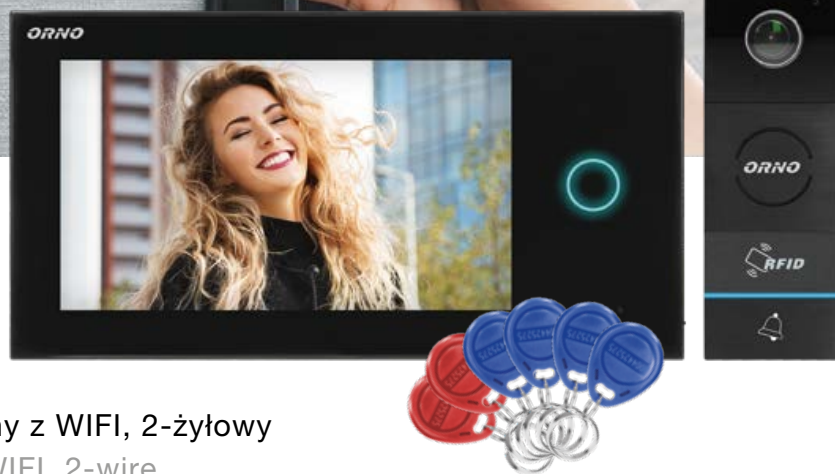

Główne cechy / Main features



Ekran dotykowy
Touchscreen



Czytnik zbliżeniowy
Proximity tags reader



Sterowanie bramą
Gate opening



Możliwość rozbudowy o dodatkowy monitor
Possibility of extension by an additional monitor



Możliwość rozbudowy o dodatkowy panel zewnętrzny
Possibility of extension by an additional outdoor unit



2-żyłowy system łączenia
2-wire connection system



Funkcja pamięci
Memory function



Czytnik kart SD
SD card reader



Oświetlenie nocne: IR
Night vision: IR



Funkcja interkomu
Intercom function



Obsługa przez aplikację w smartfonie
Compatible with smartphone APP



Symbol Product no.	EAN	Wyświetlacz Display	Kolor Color	Kąty (pion/poziom) Angles (V/H)	Dzwonki Ringtones	Monitor (szer./wys./gt. [mm]) Monitor (W/H/D [mm])	Panel zew. (szer./wys./gt. [mm]) Outdoor unit (W/H/D [mm])
OR-VID-WI-1068/B	5908254800603	7" LCD	czarny black	60° / 115°	25	230 / 120 / 25	47 / 133 / 26

AMMO

Zestaw wideodomofonowy jednorodzinny, 4-żyłowy
Single family videodoorphone set, 4-wire



Główne cechy / Main features



Sterowanie bramą
Gate opening



Możliwość rozbudowy o kamerę CCTV
Possibility of extension by CCTV camera



Oświetlenie nocne: IR
Night vision: IR

Symbol Product no.	EAN	Wyświetlacz Display	Kolor Color	Kąty (pion/poziom) Angles (V/H)	Dzwonki Ringtones	Monitor (szer./wys./gł. [mm]) Monitor (W/H/D [mm])	Panelzew. (szer./wys./gł. [mm]) Outdoor unit (W/H/D [mm])
OR-VID-SU-1058/W	5900378651031	4,3" LCD	biały white	33° / 48°	10	166 / 95 / 21	95 / 133 / 50

DUX

Zestaw wideodomofonowy jednorodzinny, 4-żyłowy
Single family videodoorphone set, 4-wire



Główne cechy / Main features



Sterowanie bramą
Gate opening



Funkcja interkomu
Intercom function



Oświetlenie nocne: białe LED
Night vision: white LED



Możliwość rozbudowy o dodatkowy monitor
Possibility of extension by an additional monitor

Symbol Product no.	EAN	Wyświetlacz Display	Kolor Color	Kąty (pion/poziom) Angles (V/H)	Dzwonki Ringtones	Monitor (szer./wys./gł. [mm]) Monitor (W/H/D [mm])	Panelzew. (szer./wys./gł. [mm]) Outdoor unit (W/H/D [mm])
OR-VID-MT-1050	5902560327052	4,3" LCD	czarny black	36° / 49°	16	142 / 145 / 19	58 / 145 / 30

NAOS RFID

Zestaw wideodomofonowy jednorodzinny, 2-żyłowy
Single family videodoorphone set, 2-wire



Główne cechy / Main features

Sterowanie bramą
Gate opening



Możliwość rozbudowy o dodatkowy monitor
Possibility of extension by an additional monitor



Funkcja interkomu
Intercom function



Czytnik zbliżeniowy
Proximity tags reader



Oświetlenie nocne: IR
Night vision: IR



2-żyłowy system łączenia
2-wire connection system



Symbol Product no.	EAN	Wyświetlacz Display	Kolor Color	Kąty (pion/poziom) Angles (V/H)	Dzwonki Ringtones	Monitor (szer./wys./gł. [mm]) Monitor (W/H/D [mm])	Panel zew. (szer./wys./gł. [mm]) Outdoor unit (W/H/D [mm])
OR-VID-SH-1074	5908254807718	4,3" LCD	czarny black	33° / 47°	10	120 / 130 / 24,5	93 / 150 / 45

IMAGO

Zestaw wideodomofonowy jednorodzinny, 4-żyłowy
Single family videodoorphone set, 4-wire



Główne cechy / Main features

Sterowanie bramą
Gate opening



Możliwość rozbudowy o dodatkowy monitor
Possibility of extension by an additional monitor



Oświetlenie nocne: IR
Night vision: IR



Warianty produktu / Available options

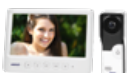

OR-VID-MC-1059/W



OR-VID-MC-1059/B





Symbol Product no.	EAN	Wyświetlacz Display	Kolor Color	Kąty (pion/poziom) Angles (V/H)	Dzwonki Ringtones	Monitor (szer./wys./gł. [mm]) Monitor (W/H/D [mm])	Panel zew. (szer./wys./gł. [mm]) Outdoor unit (W/H/D [mm])
OR-VID-MC-1059/W	5900378653202	7" LCD	biały white	66° / 86°	16	182 / 133 / 19,5	44,5 / 124,5 / 42
OR-VID-MC-1059/B	5900378653233	7" LCD	czarny black	66° / 86°	16	182 / 133 / 19,5	44,5 / 124,5 / 42

CERES

Zestaw wideodomofonowy jednorodzinny, 4-żyłowy
Single family videodoorphone set, 4-wire



Główne cechy / Main features

-  Sterowanie bramą
Gate opening
-  Możliwość rozbudowy o dodatkowy monitor
Possibility of extension by an additional monitor
-  Oświetlenie nocne: IR
Night vision: IR
-  Wbudowany szyfrator
Built-in code lock

Warianty produktu / Available options



OR-VID-ME-1056/W OR-VID-ME-1056/B

Symbol Product no.	EAN	Wyświetlacz Display	Kolor Color	Kąty (pion/poziom) Angles (V/H)	Dzwonki Ringtones	Monitor (szer./wys./gl. [mm]) Monitor (W/H/D [mm])	Panel zew. (szer./wys./gl. [mm]) Outdoor unit (W/H/D [mm])
OR-VID-ME-1056/W	5900378650591	7" LCD	biały white	77° / 100°	16	214 / 152 / 18	50 / 150 / 26
OR-VID-ME-1056/B	5908254801259	7" LCD	czarny black	77° / 100°	16	214 / 152 / 18	50 / 150 / 26

ARCUS RFID

Zestaw wideodomofonowy jednorodzinny, 4-żyłowy
Single family videodoorphone set, 4-wire



Główne cechy / Main features

-  Sterowanie bramą
Gate opening
-  Funkcja pamięci
Memory function
-  Czytnik zbliżeniowy
Proximity tags reader
-  Obiektyw typu pin-hole (niewidoczna kamera)
Pin-hole camera
-  Oświetlenie nocne: IR
Night vision: IR

Warianty produktu / Available options

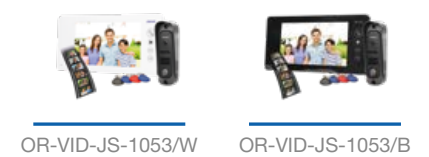

OR-VID-JS-1053/W OR-VID-JS-1053/B

Symbol Product no.	EAN	Wyświetlacz Display	Kolor Color	Kąty (pion/poziom) Angles (V/H)	Dzwonki Ringtones	Monitor (szer./wys./gl. [mm]) Monitor (W/H/D [mm])	Panel zew. (szer./wys./gl. [mm]) Outdoor unit (W/H/D [mm])
OR-VID-JS-1053/W	5900378650683	7" LCD	biały white	32° / 34°	9	240 / 114 / 12	43,2 / 140,6 / 29,3
OR-VID-JS-1053/B	5900378650676	7" LCD	czarny black	32° / 34°	9	240 / 114 / 12	43,2 / 140,6 / 29,3

INDI N

Zestaw wideodomofonowy jednorodzinny, natynkowy, 4-żyłowy
Single family videodoorphone set, surface mounted, 4-wire



Główne cechy / Main features

Sterowanie bramą
Gate opening



Możliwość rozbudowy o dodatkowy monitor
Possibility of extension by an additional monitor



Funkcja interkomu
Intercom function



Czytnik zbliżeniowy
Proximity tags reader



Oświetlenie nocne: białe LED
Night vision: white LED



Symbol Product no.	EAN	Wyświetlacz Display	Kolor Color	Kąty (pion/poziom) Angles (V/H)	Dzwonki Ringtones	Monitor (szer./wys./gł. [mm]) Monitor (W/H/D [mm])	Panelzew. (szer./wys./gł. [mm]) Outdoor unit (W/H/D [mm])
OR-VID-VP-1069/B	5908254800610	7" LCD	czarny black	65° / 90°	16	216 / 129,7 / 23	109 / 158 / 57

INDI P

Zestaw wideodomofonowy jednorodzinny, podtynkowy, 4-żyłowy
Single family videodoorphone set, flush mounted 4-wire



Główne cechy / Main features

Sterowanie bramą
Gate opening



Możliwość rozbudowy o dodatkowy monitor
Possibility of extension by an additional monitor



Funkcja interkomu
Intercom function



Czytnik zbliżeniowy
Proximity tags reader



Oświetlenie nocne: białe LED
Night vision: white LED







Symbol Product no.	EAN	Wyświetlacz Display	Kolor Color	Kąty (pion/poziom) Angles (V/H)	Dzwonki Ringtones	Monitor (szer./wys./gł. [mm]) Monitor (W/H/D [mm])	Panelzew. (szer./wys./gł. [mm]) Outdoor unit (W/H/D [mm])
OR-VID-VP-1070/B	5908254802331	7" LCD	czarny black	65° / 90°	16	216 / 129,7 / 23	122 / 182 / 48

SCUTI

Zestaw wideodomofonowy jednorodzinny, 5-żyłowy
Single family videodoorphone set, 5-wire

Główne cechy / Main features

-  Sterowanie bramą
Gate opening
-  Możliwość rozbudowy o dodatkowy monitor
Possibility of extension by an additional monitor
-  Funkcja interkomu
Intercom function
-  Wbudowany szyfrator
Built-in code lock
-  Oświetlenie nocne: IR
Night vision: IR



Warianty produktu / Available options

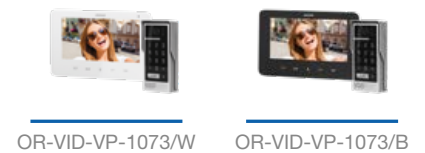

Symbol Product no.	EAN	Wyświetlacz Display	Kolor Color	Kąty (pion/poziom) Angles (V/H)	Dzwonki Ringtones	Monitor (szer./wys./gt. [mm]) Monitor (W/H/D [mm])	Panel zew. (szer./wys./gt. [mm]) Outdoor unit (W/H/D [mm])
OR-VID-VP-1073/W	5908254802379	7" LCD	biały white	64° / 96°	16	216 / 129,7 / 23	63 / 150 / 24
OR-VID-VP-1073/B	5908254802362	7" LCD	czarny black	64° / 96°	16	216 / 129,7 / 23	63 / 150 / 24

SEMIS MEMO

Zestaw wideodomofonowy bezprzewodowy
Single family videodoorphone, wireless

Główne cechy / Main features

-  Możliwość rozbudowy o dodatkowy monitor
Possibility of extension by an additional monitor
-  Możliwość rozbudowy o dodatkowy panel zewnętrzny
Possibility of extension by an additional outdoor unit
-  Funkcja pamięci
Memory function
-  Oświetlenie nocne: białe LED
Night vision: white LED
-  Zasięg: 150m
Range: 150m



Symbol Product no.	EAN	Wyświetlacz Display	Kolor Color	Kąty (pion/poziom) Angles (V/H)	Dzwonki Ringtones	Monitor (szer./wys./gt. [mm]) Monitor (W/H/D [mm])	Panel zew. (szer./wys./gt. [mm]) Outdoor unit (W/H/D [mm])
OR-VID-XE-1051/W	5902560328707	2,4" LCD	biały white	90° / 65°	3	52,7 / 188,2 / 26,3	105 / 167 / 50

Model Product no.	OR-VID-WI-1068/B	OR-VID-SU-1058/W	OR-VID-MT-1050	OR-VID-SH-1074
EAN	5908254800603	5900378651031	5902560327052	5908254807718
Rodzaj transmisji Type of transmission	przewodowy (wired) / WiFi-APP	przewodowy (wired)	przewodowy (wired)	przewodowy (wired)
Rodzaj zasilania Type of power supply	zasilacz sieciowy (plug-in power supply)	zasilacz sieciowy (plug-in power supply)	zasilacz sieciowy (plug-in power supply)	zasilacz sieciowy (plug-in power supply)
System łączenia Connection system	2-żyłowy (2-wire)	4-żyłowy (4-wire)	4-żyłowy (4-wire)	2-żyłowy (2-wire)
Ilość przewodów Number of wires	2+2	4+2	4+2	2+2
System łączenia elektrozaczepek System of the electrical lock connection	2+2 z panelem zewnętrznym with outdoor unit	4+2 z panelem zewnętrznym with outdoor unit	4+2 z panelem zewnętrznym with outdoor unit	2+2 z panelem zewnętrznym with outdoor unit
Zasilanie elektrozaczepek Power supply of the electric strike	zasilanie z wideodomofonu (powered from videodoorphone)	zasilanie z wideodomofonu (powered from videodoorphone)	zasilanie z wideodomofonu (powered from videodoorphone)	zasilanie z wideodomofonu (powered from videodoorphone)
Sterowanie bramą automatyczną Control of the automatic gate	✓	✓	✓	✓
Możliwość rozbudowy o dodatkowy panel zewnętrzny Possibility of extension by an additional outdoor unit	✓	✗	✗	✗
Możliwość rozbudowy o dodatkowy monitor Possibility of extension by an additional monitor	✓	✗	✓	✓
Możliwość rozbudowy o kamerę CCTV Possibility of extension by an additional cctv camera	✗	✓	✗	✗
Zasięg w terenie otwartym Range in the open area	✗	✗	✗	✗
MONITOR / MONITOR				
Obsługa Operation	głošnomówiący (hands-free)	głošnomówiący (hands-free)	głošnomówiący (hands-free)	głošnomówiący (hands-free)
Wyświetlacz (Display)	7" LCD	4,3" LCD	4,3" LCD	4,3" LCD
Rozdzielczość monitora (Resolution of the monitor's screen)	1024 x 600	480 x 272	480 x 272	480 x 272
Kolor monitora Color of the monitor	czarny (black)	biały (white)	czarny (black)	czarny (black)
Pamięć (Memory)	✓	✗	✗	✗
Czytnik kart SD (SD card reader)	✓	✗	✗	✗
Funkcja Interkomu (Intercom function)	✓	✗	✓	✓
Ilość dźwięków dzwonka (Number of ringtones)	25	10	16	10
Ekran dotykowy (Touch screen)	✓	✗	✗	✗
Wymiary (szer./wys./gt. [mm]) (Dimensions (W / H / D [mm]))	230 / 120 / 25	166 / 95 / 21	142 / 145 / 19	120 / 130 / 24,5
Inne cechy monitora Other features of the monitor	Wi-Fi - Android/iOS APP	✗	✗	✗
PANEL ZEWNĘTRZNY Z KAMERĄ / OUTDOOR UNIT WITH A CAMERA				
Typ kamery Type of camera	tradycyjny obiektyw (standard lens)	tradycyjny obiektyw (standard lens)	tradycyjny obiektyw (standard lens)	tradycyjny obiektyw (standard lens)
Kąt widzenia pion/poziom (Vertical/horizontal view angle)	60° / 115°	33° / 48°	36° / 49°	33° / 47°
Rozdzielczość kamery (Resolution of the camera)	720P	420TVL	700 TVL	733 x 493
Montaż Installation	natynkowy (surface mounted)	natynkowy (surface mounted)	natynkowy (surface mounted)	natynkowy (surface mounted)
Czytnik kart i breloków zbliżeniowych Card and proximity tags reader	✓	✗	✗	✓
Szyfrator (Code lock)	✗	✗	✗	✗
Oświetlenie nocne (Night lighting)	podczerwień (IR)	podczerwień (IR)	białe diody LED (white LED diodes)	podczerwień (IR)
Wymiary (szer./wys./gt. [mm]) (Dimensions (W / H / D [mm]))	47 / 133 / 26	95 / 133 / 50	58 / 145 / 30	93 / 150 / 45
Stopień ochrony (Protection rating)	IP44	IP44	IP44	IP44
Inne cechy kamery Other features of the camera	wymienna tabliczka na grawer nazwiska (spare name plate for engraving)	wbudowany czujnik zmiernochwy sterujący podświetleniem nazwiska (Integrated twilight sensor for nameplate backlight)	✗	wbudowany czujnik zmiernochwy sterujący podświetleniem nazwiska (Integrated twilight sensor for nameplate backlight)

OR-VID-MC-1059/B OR-VID-MC-1059/W	OR-VID-ME-1056/B OR-VID-ME-1056/W	OR-VID-JS-1053/B OR-VID-JS-1053/W	OR-VID-VP-1069/B	OR-VID-VP-1070/B	OR-VID-VP-1073/B OR-VID-VP-1073/W	OR-VID-XE-1051/W
5900378653233 5900378653202	5908254801259 5900378650591	5900378650676 5900378650683	5908254800610	5908254802331	5908254802362 5908254802379	5902560328707
przewodowy (wired)	przewodowy (wired)	przewodowy (wired)	przewodowy (wired)	przewodowy (wired)	przewodowy (wired)	beprzewodowy (wireless)
zasilacz sieciowy (plug-in power supply)	zasilacz sieciowy (plug-in power supply)	zasilacz sieciowy (plug-in power supply)	zasilacz sieciowy (plug-in power supply)	zasilacz sieciowy (plug-in power supply)	zasilacz sieciowy (plug-in power supply)	zasilacz sieciowy (plug-in power supply)
4-żyłowy (4-wire)	4-żyłowy (4-wire)	4-żyłowy (4-wire)	4-żyłowy (4-wire)	4-żyłowy (4-wire)	5-żyłowy (5-wire)	✗
4+2	4+2	4+2	4+2	4+2	5+2	✗
4+2 z panelem zewnętrznym with outdoor unit	4+2 z panelem zewnętrznym with outdoor unit	4+2 z panelem zewnętrznym with outdoor unit	4+2 z panelem zewnętrznym with outdoor unit	4+2 z panelem zewnętrznym with outdoor unit	5+2 z panelem zewnętrznym with outdoor unit	✗
zasilanie z wideodomofonu (powered from videodoorphone)	zasilanie z wideodomofonu (powered from videodoorphone)	zasilanie z wideodomofonu (powered from videodoorphone)	zasilanie z wideodomofonu (powered from videodoorphone)	zasilanie z wideodomofonu (powered from videodoorphone)	zasilanie z wideodomofonu (powered from videodoorphone)	potrzebne dodatkowe zasilanie (additional power supply required)
✓	✓	✓	✓	✓	✓	✗
✗	✗	✗	✗	✗	✗	✓
✓	✓	✗	✓	✓	✓	✓
✗	✗	✗	✗	✗	✗	✗
✗	✗	✗	✗	✗	✗	150m
głošnomówiący (hands-free)	głošnomówiący (hands-free)	głošnomówiący (hands-free)	głošnomówiący (hands-free)	głošnomówiący (hands-free)	głošnomówiący (hands-free)	sluchawka (with handset)
7" LCD	7" LCD	7" LCD	7" LCD	7" LCD	7" LCD	2,4" LCD
800 x 480	800 x 480	800 x 480	800 x 480	800 x 480	800 x 480	320 x 240
czarny (czarny) biały (white)	czarny (czarny) biały (white)	czarny (czarny) biały (white)	czarny (black)	czarny (black)	czarny (czarny) biały (white)	czarny (black)
✗	✗	✓	✗	✗	✗	✓
✗	✗	✗	✗	✗	✗	✗
✗	✗	✗	✓	✓	✓	✗
16	16	9	16	16	16	3
✗	✗	✗	✗	✗	✗	✗
182 / 133 / 19,5	214 / 152 / 18	240 / 114 / 12	216 / 129,7 / 23	216 / 129,7 / 23	216 / 129,7 / 23	52,7 / 188,2 / 26,3
✗	✗	✗	✗	✗	✗	akumulator wbudowany w sluchawkę ładowany z bazy (handset with battery charged from the base)
tradycyjny obiektyw (standard lens)	tradycyjny obiektyw (standard lens)	pin-hole (niewidoczna kamera) (hidden camera)	tradycyjny obiektyw (standard lens)	tradycyjny obiektyw (standard lens)	tradycyjny obiektyw (standard lens)	tradycyjny obiektyw (standard lens)
66° / 86°	77° / 100°	32° / 34°	65° / 90°	65° / 90°	64° / 96°	90° / 65°
600TVL	700TVL	0,3 Mpix	420 TVL	420 TVL	600 TVL	0,3 Mpix
natynkowy (surface mounted)	natynkowy (surface mounted)	natynkowy (surface mounted)	natynkowy (surface mounted)	podtynkowy (flush mounted)	natynkowy (surface mounted)	natynkowy (surface mounted)
✗	✗	✓	✓	✓	✗	✗
✗	✓	✗	✗	✗	✓	✗
podczerwień (IR)	podczerwień (IR)	podczerwień (IR)	białe diody LED (white LED diodes)	białe diody LED (white LED diodes)	podczerwień (IR)	białe diody LED (white LED diodes)
44,5 / 124,5 / 42	50 / 150 / 26	43,2 / 140,6 / 29,3	109 / 158 / 57	122 / 182 / 48	63 / 150 / 24	105 / 167 / 50
IP65	IP65	IP44	IP44	IP44	IP44	IP44
✗	✗	✗	✗	✗	✗	opcja baterijnego zasilania, sygnał alarmowy w przypadku próby usunięcia panelu zewnętrznego (optional battery, anti-tamper alarm)

INDI MULTI N

Zestaw wideodomofonowy 2-rodzinny, 4-żyłowy
Two family videodoorphone set, 4-wire



Główne cechy / Main features

Sterowanie bramą
Gate opening



Możliwość rozbudowy o dodatkowy monitor
Possibility of extension by an additional monitor



Funkcja interkomu
Intercom function



Czytnik zbliżeniowy
Proximity tags reader



Oświetlenie nocne: białe LED
Night vision: white LED



Symbol Product no.	EAN	Wyświetlacz Display	Kolor Color	Kąty (pion/poziom) Angles (V/H)	Dzwonki Ringtones	Monitor (szer./wys./gł. [mm]) Monitor (W/H/D [mm])	Panelzew. (szer./wys./gł. [mm]) Outdoor unit (W/H/D [mm])
OR-VID-VP-1071/B	5908254802348	7" LCD	czarny black	65° / 90°	16	216 / 129,7 / 23	109 / 158 / 57

INDI MULTI P

Zestaw wideodomofonowy 2-rodzinny, 4-żyłowy
Two family videodoorphone set, 4-wire



Główne cechy / Main features

Sterowanie bramą
Gate opening



Możliwość rozbudowy o dodatkowy monitor
Possibility of extension by an additional monitor



Funkcja interkomu
Intercom function



Czytnik zbliżeniowy
Proximity tags reader



Oświetlenie nocne: białe LED
Night vision: white LED



Symbol Product no.	EAN	Wyświetlacz Display	Kolor Color	Kąty (pion/poziom) Angles (V/H)	Dzwonki Ringtones	Monitor (szer./wys./gł. [mm]) Monitor (W/H/D [mm])	Panelzew. (szer./wys./gł. [mm]) Outdoor unit (W/H/D [mm])
OR-VID-VP-1072/B	5908254802355	7" LCD	czarny black	65° / 90°	16	216 / 129,7 / 23	122 / 182 / 48

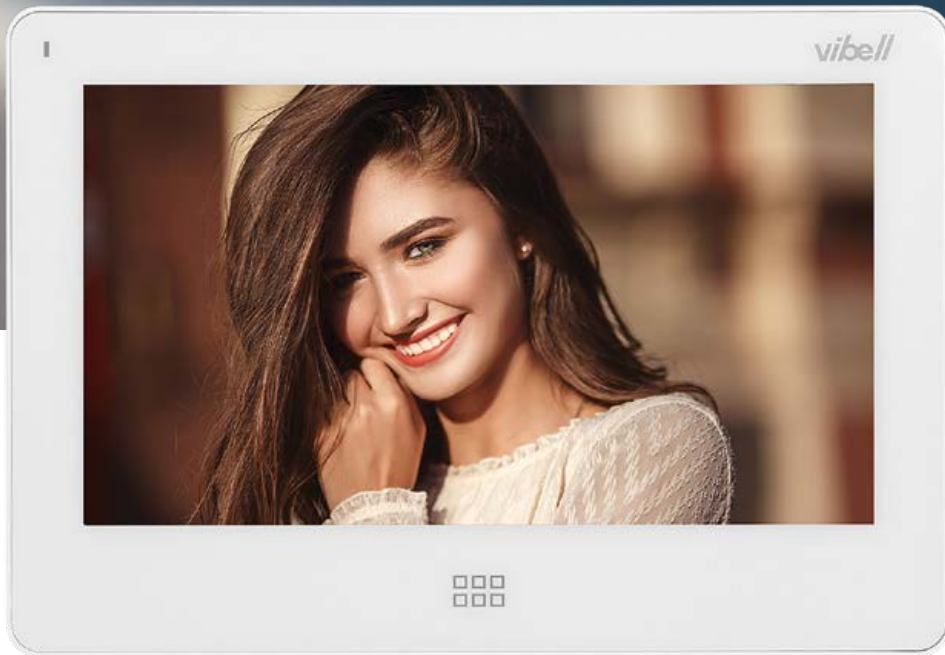

vibell
PROFESSIONAL SYSTEMS

PROFESJONALNE
SYSTEMY **WIDEODOMOFONOWE**

PROFESSIONAL VIDEODOORPHONE SYSTEMS

vibell

PROFESSIONAL SYSTEMS

Vibell to synonim wysokiej jakości, nowoczesnej technologii i dużej funkcjonalności. Nasze zestawy wideodomofonowe posiadają wszystkie te cechy. Wyposażyliśmy je w kolorowe, płaskie monitory LCD o wysokiej rozdzielczości z podświetlanymi, dotykowymi przyciskami lub ekranem dotykowym. Zapomnij o tradycyjnej słuchawce. Od teraz możesz łatwo i skutecznie komunikować się z osobami na zewnątrz bezpośrednio z poziomu monitora. Panele zewnętrzne wyposażone w szerokokątne kamery posiadają atrakcyjną oraz bardzo wytrzymałą obudowę i dodatkowe oświetlenie diodami LED, aby zagwarantować użytkownikom obraz jak najlepszej jakości, nawet po zmroku. Zestaw daje olbrzymie możliwości rozbudowy o dodatkowe elementy z serii.

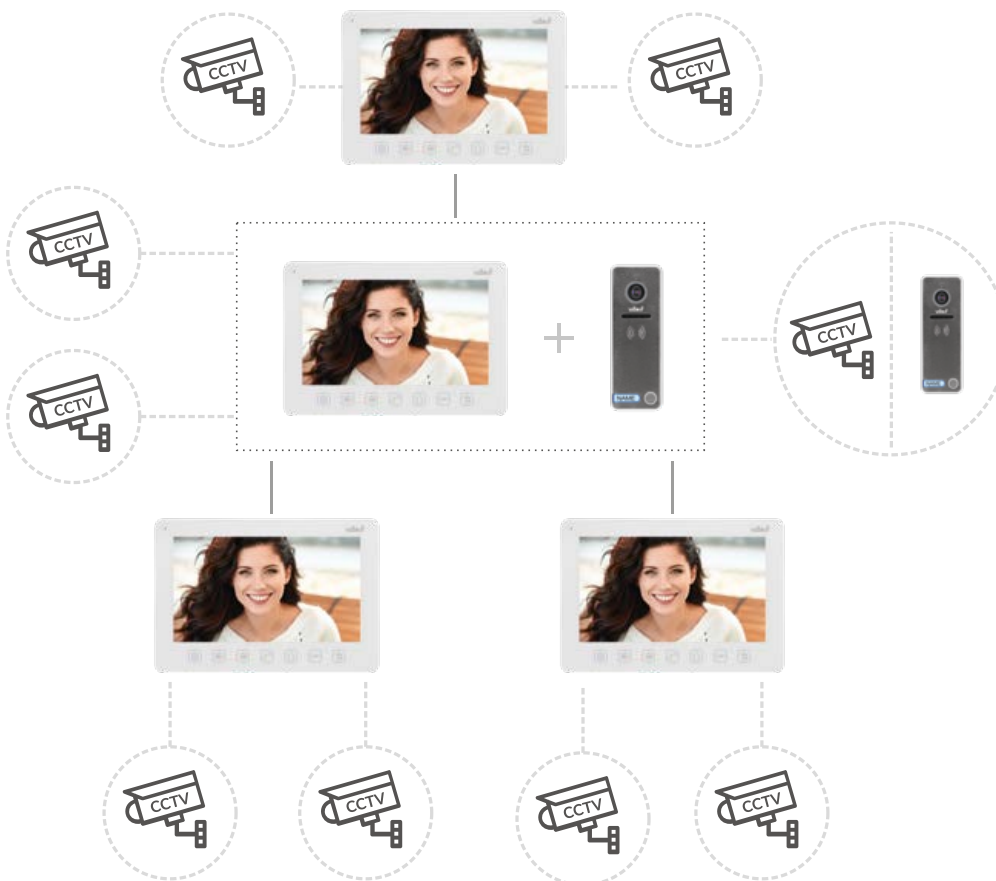

VIBELL is synonymous with high quality, state-of-the-art technology and high functionality. Our video door phone sets feature all of the above. They have been equipped with multicolor, ultra-flat and high-resolution LCD monitors with backlit touch buttons or touch screen. Forget the old-fashioned handset. From now on you can easily and effectively talk to the visitors outside through a loud speaking monitor. The external, wide-angle cameras are closed inside nice-looking and very durable panels, and have additional lighting provided by LED diodes, to ensure best possible picture even after dark. The set can be vastly expanded with additional devices from VIBELL series.

System components / Elementy systemu

Panele zewnętrzne

Outdoor units



OR-VID-EX-1057KV



OR-VID-EX-1063KV



OR-VID-EX-1064KV



OR-VID-EX-1061KV

Wysoka szczelność panelu zewnętrznego
High weather resistance of the outdoor unit



Oświetlenie nocne: białe LED
Night vision: white LED



Wysoka szczelność panelu zewnętrznego
High weather resistance of the outdoor unit



Czytnik zbliżeniowy
Proximity tags reader



Wbudowany szyfrator
Built-in code lock



Oświetlenie nocne: IR
Night vision: IR



Symbol Product no.	EAN	Kolor Color	Stopień ochrony Protection rating	Kąty (pion/poziom) Angles (V/H)	Wymiary (szer./wys./gl. [mm]) Dimensions (W/H/D [mm])
OR-VID-EX-1057KV	5900378655664	srebrny silver	IP65	96° / 110°	55 / 152 / 21
OR-VID-EX-1063KV	5900378659204	srebrny silver	IP65	96° / 110°	55 / 152 / 21
OR-VID-EX-1064KV	5900378659211	srebrny silver	IP65	96° / 110°	55 / 152 / 21
OR-VID-EX-1061KV	5900378655886	czarny black	IP65	57° / 110°	55 / 152 / 22



Monitor FELIS MEMO

Główne cechy / Main features



Sterowanie bramą
Gate opening



Funkcja interkomu
Intercom function



Funkcja rozgłoszeniowa
Broadcast function



Ekran dotykowy
Touchscreen



Ramka cyfrowa
Digital frame



Funkcja pamięci
Memory function



Czytnik kart SD
SD card reader



Funkcja DVR
DVR function



Odtwarzacz multimedialny
Multimedia player



Kalendarz, budzik, automatyczna sekretarka
Calendar, alarm clock, answering machine

Symbol Product no.	EAN	Wyświetlacz Display	Rozdzielczość Resolution	Dzwonki Ringtones	Kolor Color	Wymiary (szer./wys./gł. [mm]) Dimensions (W/H/D [mm])
OR-VID-EX-1060PMV/W	5900378655657	7" LCD	800 x 480	7	biały white	185 / 127 / 18
OR-VID-EX-1060PMV/B	5900378659198	7" LCD	800 x 480	7	czarny black	185 / 127 / 18



Monitor NOVEO

Główne cechy / Main features

Funkcja rozgłoszeniowa
Broadcast function



Przyciski dotykowe
Touch buttons



Sterowanie bramą
Gate opening



Funkcja interkomu
Intercom function



Symbol Product no.	EAN	Wyświetlacz Display	Rozdzielczość Resolution	Dzwonki Ringtones	Kolor Color	Wymiary (szer./wys./gł. [mm]) Dimensions (W/H/D [mm])
OR-VID-EX-1057MV/W	5900378655640	7" LCD	800 x 480	12	biały white	185 / 127 / 18
OR-VID-EX-1057MV/B	5900378659181	7" LCD	800 x 480	12	czarny black	185 / 127 / 18

Przykładowe zestawy / Examples of sets

ALCOR

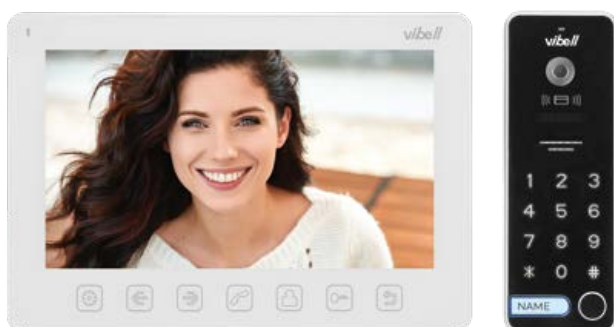

OR-VID-EX-1061/W

NOVEO

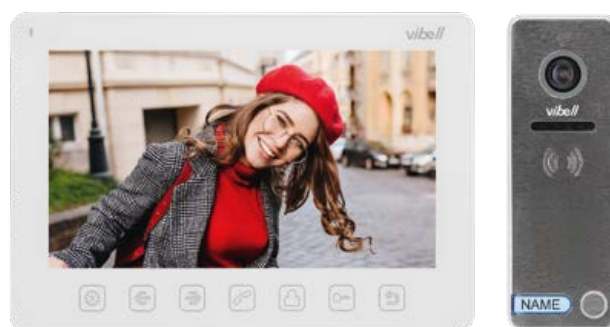

OR-VID-EX-1057/W

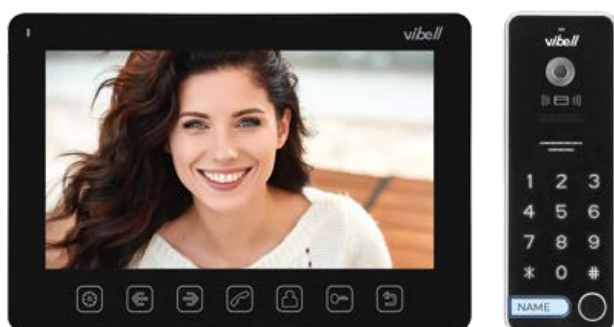

OR-VID-EX-1061/B

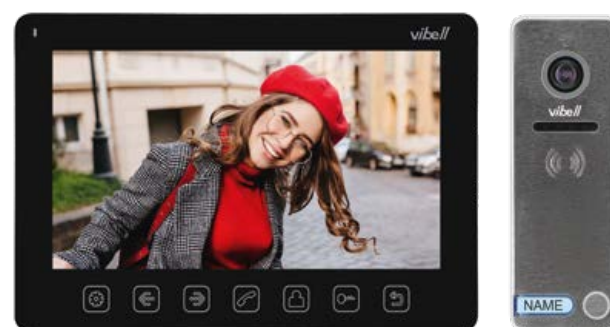

OR-VID-EX-1057/B

Symbol Product no.	EAN	Wyświetlacz Display	Kolor Color	Kąty (pion/poziom) Angles (V/H)	Dzwonki Ringtones	Monitor (szer./wys./gl. [mm]) Monitor (W/H/D [mm])	Panelzew. (szer./wys./gl. [mm]) Outdoor unit (W/H/D [mm])
OR-VID-EX-1061/W	5900378655848	7" LCD	biały white	57° / 110°	13	185 / 127 / 17	55 / 152 / 22
OR-VID-EX-1061/B	5900378655855	7" LCD	czarny black	57° / 110°	13	185 / 127 / 17	55 / 152 / 22
OR-VID-EX-1057/W	5900378655800	7" LCD	biały white	96° / 110°	12	185 / 127 / 17	55 / 152 / 21
OR-VID-EX-1057/B	5900378655817	7" LCD	czarny black	96° / 110°	12	185 / 127 / 17	55 / 152 / 21

FELIS MEMO MULTI2

Warianty produktu / Available options

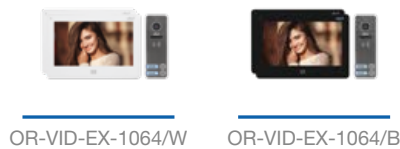

Symbol Product no.	EAN	Wyświetlacz Display	Kolor Color	Kąty (pion/poziom) Angles (V/H)	Dzwonki Ringtones	Monitor (szer./wys./gt. [mm]) Monitor (W/H/D [mm])	Panel zew. (szer./wys./gt. [mm]) Outdoor unit (W/H/D [mm])
OR-VID-EX-1064/W	5900378659266	7" LCD	biały white	96° / 110°	7	185 / 127 / 18	55 / 152 / 21
OR-VID-EX-1064/B	5900378659273	7" LCD	czarny black	96° / 110°	7	185 / 127 / 18	55 / 152 / 21

FELIS MEMO MULTI4

Warianty produktu / Available options

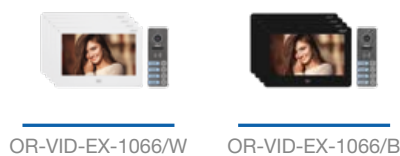

Symbol Product no.	EAN	Wyświetlacz Display	Kolor Color	Kąty (pion/poziom) Angles (V/H)	Dzwonki Ringtones	Monitor (szer./wys./gt. [mm]) Monitor (W/H/D [mm])	Panel zew. (szer./wys./gt. [mm]) Outdoor unit (W/H/D [mm])
OR-VID-EX-1066/W	5900378659228	7" LCD	biały white	96° / 110°	7	185 / 127 / 18	55 / 152 / 21
OR-VID-EX-1066/B	5900378659235	7" LCD	czarny black	96° / 110°	7	185 / 127 / 18	55 / 152 / 21



WIZJERY ELEKTRONICZNE

DOOR VIEWERS



Elektroniczny wizjer do drzwi z wbudowanym czujnikiem ruchu

Electronic door viewer
with integrated motion sensor

Główne cechy / Main features



Darmowa aplikacja
Free App



Czytnik kart SD
SD card reader



Standard komunikacji: WiFi 2,4GHz
Communication protocol: WiFi 2,4GHz



Oświetlenie nocne: IR
Night vision: IR



Funkcja pamięci
Memory function



Czujnik ruchu
Motion sensor



Wymiary (szer./wys./gt. [mm]):
Monitor: 141 / 97 / 22, Kamera: 61 / 61 / 13
Dimensions (W/H/D [mm]):
Monitor: 141 / 97 / 22, Camera: 61 / 61 / 13

Symbol Product no.	EAN	Zasilanie Power supply	Wyświetlacz Display	Kolor Color	Kąty (pion/poziom) Angles (V/H)	Wymiary otworu montażowego [mm] Dimensions of the mounting hole [mm]	Zakres grubości drzwi [mm] Door thickness range [mm]
OR-WIZ-1109	5908254820861	bateria li-po 3,7VDC 3500mAh	4,3" LCD	czarno-srebrny silver-black	45° / 77°	Ø14 - 35	35 - 100

Elektroniczny wizjer do drzwi Electronic door viewer

Główne cechy / Main features



Funkcja pamięci
Memory function



Czytnik kart SD
SD card reader



Wymiary (szer./wys./gt. [mm]):
Monitor: 136 / 75 / 18, Kamera: 30 / 30 / 35
Dimensions (W/H/D [mm]):
Monitor: 136 / 75 / 18, Camera: 30 / 30 / 35



Symbol Product no.	EAN	Zasilanie Power supply	Wyświetlacz Display	Kolor Color	Kąty (pion/poziom) Angles (V/H)	Wymiary otworu montażowego [mm] Dimensions of the mounting hole [mm]	Zakres grubości drzwi [mm] Door thickness range [mm]
OR-WIZ-1101	5901752483828	3 x AA	2,8" LCD	złoty gold	60° / 70°	Ø13 - 30	35 - 85

Elektroniczny wizjer do drzwi Electronic door viewer

Główne cechy / Main features



Wymiary (szer./wys./gt. [mm]):
Monitor: 121 / 64 / 17, Kamera: 32 / 32 / 49
Dimensions (W/H/D [mm]):
Monitor: 121 / 64 / 17, Camera: 32 / 32 / 49



Symbol Product no.	EAN	Zasilanie Power supply	Wyświetlacz Display	Kolor Color	Kąty (pion/poziom) Angles (V/H)	Wymiary otworu montażowego [mm] Dimensions of the mounting hole [mm]	Zakres grubości drzwi [mm] Door thickness range [mm]
OR-WIZ-1107	5900378654612	3 x AAA	4" LCD	srebrny silver	65° / 95°	Ø14 - 30	42 - 70

Elektroniczny wizjer do drzwi z wbudowanym czujnikiem ruchu
Electronic door viewer with integrated motion sensor



Główne cechy / Main features

Funkcja pamięci
Memory function



Czytnik kart SD
SD card reader



Czujnik ruchu
Motion sensor



Oświetlenie nocne: IR
Night vision: IR



Wymiary (szer./wys./gł. [mm]):
Monitor: 139 / 80 / 19,8, Kamera: 45 / 76,5
Dimensions (W/H/D [mm]):
Monitor: 139 / 80 / 19,8, Camera: 45 / 76,5



Symbol Product no.	EAN	Zasilanie Power supply	Wyświetlacz Display	Kolor Color	Kąty (pion/poziom) Angles (V/H)	Wymiary otworu montażowego [mm] Dimensions of the mounting hole [mm]	Zakres grubości drzwi [mm] Door thickness range [mm]
OR-WIZ-1106	5900378650072	4 x AA	4,3" LCD	srebrny silver	85° / 108°	Ø14 - 26	38 - 110

Elektroniczny wizjer do drzwi z wbudowanym czujnikiem ruchu
Electronic door viewer with integrated motion sensor



Główne cechy / Main features

Funkcja pamięci
Memory function



Czytnik kart SD
SD card reader



Czujnik ruchu
Motion sensor



Oświetlenie nocne: IR
Night vision: IR



Wymiary (szer./wys./gł. [mm]):
Monitor: 141 / 97 / 22, Kamera: 61 / 61 / 13
Dimensions (W/H/D [mm]):
Monitor: 141 / 97 / 22, Camera: 61 / 61 / 13



Symbol Product no.	EAN	Zasilanie Power supply	Wyświetlacz Display	Kolor Color	Kąty (pion/poziom) Angles (V/H)	Wymiary otworu montażowego [mm] Dimensions of the mounting hole [mm]	Zakres grubości drzwi [mm] Door thickness range [mm]
OR-WIZ-1108	5908254820854	bateria li-po 3,7VDC 3000mAh	4,3" LCD	czarno-srebrny silver-black	50° / 105°	Ø14 - 35	35 - 120

ZESTAW INTERKOMOWY

INTERCOM KIT



SECURIT

Interkom kasowy, 3-żyłowy
Window intercom, 3-wire

Główne cechy / Main features



Regulacja głośności jednostki wewnętrznej i zewnętrznej
Adjustment of external and internal units volume



Gniazdo REC
REC output



Symbol Product no.	EAN	Zasilanie Power supply	Kolor Color	Jednostka zew. (szer./wys./gt. [mm]) External unit (W/H/D [mm])	Jednostka wew. (szer./wys./gt. [mm]) Internal unit (W/H/D [mm])
OR-IK-LY-931	5908254805615	12VDC	srebrny silver	Ø71 / 21	138 / 98 / 53

KONTROLA DOSTĘPU

ACCESS CONTROL



Klamka szyfrowa z klawiaturą dotykową i funkcją smart

Smart handle with touch keypad and fingerprints reader

Główne cechy / Main features



Darmowa aplikacja
Free app



Standard komunikacji: Bluetooth 4.0
Communication protocol: Bluetooth 4.0



Wbudowany szyfrator
Inbuilt code lock



Czytnik linii papilarnych
Fingerprint reader



Możliwość nadawania dostępu stałego i tymczasowego
Temporary and permanent access can be granted



Klawiatura dotykowa
Touch keypad

Symbol Product no.	EAN	Kolor Color	Zasilanie Power supply	Stopień ochrony Protection rating	Tryb pracy Working mode	Grubość drzwi [mm] Door thickness [mm]
OR-ZS-853/N	5908254818998	nikiel nickel	4xAAA	IP20	Bluetooth / Kod / Czytnik linii papilarnych Bluetooth / Code / Fingerprint reader	38-56
OR-ZS-853/B	5908254819001	czarny black	4xAAA	IP20	Bluetooth / Kod / Czytnik linii papilarnych Bluetooth / Code / Fingerprint reader	38-56

Czytnik kart i breloków zbliżeniowych Card and proximity tags reader

Główne cechy / Main features



Czytnik zbliżeniowy
Proximity tags reader



Częstotliwość: 125 kHz
Frequency: 125 kHz



Wodoodporny
Waterproof



Wymiary (szer./wys./gł. [mm]): 70 / 120 / 38
Dimensions (W/H/D [mm]): 70 / 120 / 38



Symbol Product no.	EAN	Zasilanie Power supply	Stopień ochrony Protection rating	Maks. ilość użytkowników Max. number of users	Ilość wyjść przekaźnikowych Number of relay outputs	Obciążalność wyjść przekaźnikowych Relay output current
OR-ZS-821	5908254803383	12V DC	IP66	2000	1	2A

Zamek szyfrowy z czytnikiem kart i breloków zbliżeniowych Code lock with card and proximity tags reader

Główne cechy / Main features



Czytnik zbliżeniowy
Proximity tags reader



Częstotliwość: 125 kHz
Frequency: 125 kHz



Wbudowany szyfrator
Inbuilt code lock



Funkcja gościa (maks. 10 użytkowników)
Guest function (max. 10 users)



Wymiary (szer./wys./gł. [mm]): 50 / 120 / 20
Dimensions (W/H/D [mm]): 50 / 120 / 20



Symbol Product no.	EAN	Zasilanie Power supply	Stopień ochrony Protection rating	Maks. ilość użytkowników Max. number of users	Ilość wyjść przekaźnikowych Number of relay outputs	Obciążalność wyjść przekaźnikowych Relay output current
OR-ZS-820	5908254803376	12V DC	IP20	1000	1	3A

Zamki szyfrowe z czytnikiem kart i breloków zbliżeniowych
Code locks with card and proximity tags reader



Czytnik zbliżeniowy
Proximity tags reader



Częstotliwość: 125 kHz
Frequency: 125 kHz



Wbudowany szyfrator
Inbuilt code lock



Wodoodporny
Waterproof



OR-ZS-802DN

Daszek ochrony
do zamka szyfrowego OR-ZS-802
Protective rain cover
for OR-ZS-802

Symbol Product no.	EAN	Zasilanie Power supply	Stopień ochrony Protection rating	Maks. ilość użytkowników Max. number of users	Ilość wyjść przełącznikowych Number of relay outputs	Obciążalność wyjść przełącznikowych Relay output current	Wymiary (szer./wys./gł. [mm]) Dimensions (W/H/D [mm])
OR-ZS-802	5901752480414	12V DC	IP44	1000	1	3A	82 / 128 / 28
OR-ZS-815	5900378659457	12V DC	IP44	1000	1	3A	58 / 135 / 26
OR-ZS-804	5901752480407	12V DC	IP68	1200	2	3A /3A	58 / 135 / 26

Zamek szyfrowy z czytnikiem kart i breloków zbliżeniowych
Code lock with card and proximity tags reader



Główne cechy / Main features

Czytnik zbliżeniowy
Proximity tags reader



Częstotliwość: 125 kHz
Frequency: 125 kHz



Wodoodporny
Waterproof



Symbol Product no.	EAN	Zasilanie Power supply	Stopień ochrony Protection rating	Maks. ilość użytkowników Max. number of users	Ilość wyjść przełącznikowych Number of relay outputs	Obciążalność wyjść przełącznikowych Relay output current	Wymiary (szer./wys./gł. [mm]) Dimensions (W/H/D [mm])
OR-ZS-803	5901752481008	12V DC	IP55	1000	1	2A	46 / 160 / 19

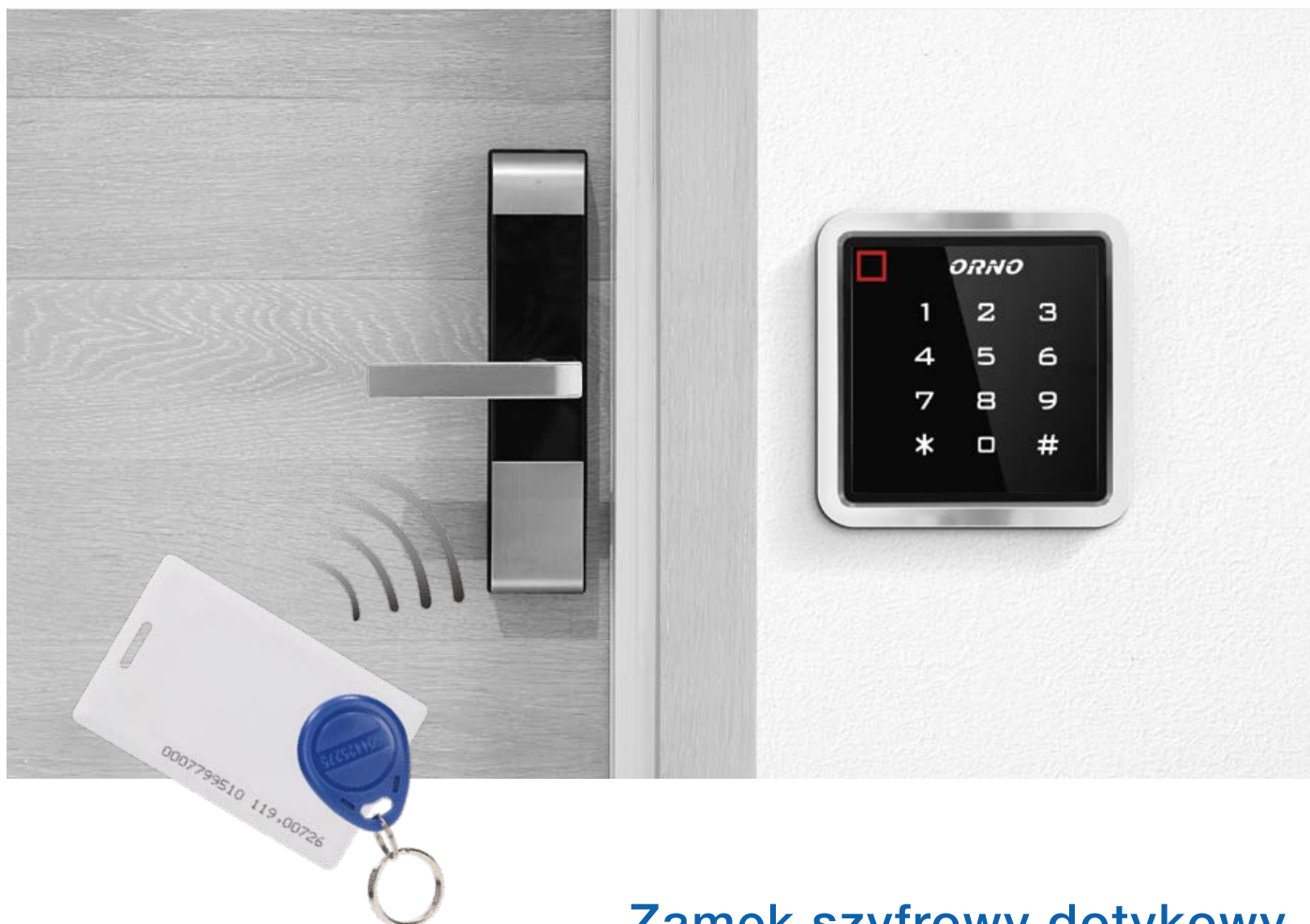

Zamek szyfrowy dotykowy z czytnikiem kart i breloków zbliżeniowych

Code lock with touch keypad
card and proximity tags reader

Główne cechy / Main features

Klawiatura dotykowa
Touch keypad



Wbudowany szyfrator
Inbuilt code lock



Czytnik zbliżeniowy
Proximity tags reader



Częstotliwość: 125 kHz
Frequency: 125 kHz



Wodoodporny
Waterproof



Symbol Product no.	EAN	Zasilanie Power supply	Stopień ochrony Protection rating	Maks. ilość użytkowników Max. number of users	Ilość wyjść przekaźnikowych Number of relay outputs	Obciążalność wyjść przekaźnikowych Relay output current	Wymiary (szer./wys./gt. [mm]) Dimensions (W/H/D [mm])
OR-ZS-816	5900378658320	12V DC	IP68	2000	1	3A	86 / 86 / 20

Zamek szyfrowy dotykowy z czytnikiem kart i breloków zbliżeniowych oraz przyciskiem dzwonkowym
Code lock with card and proximity tags reader, doorbell button and Bluetooth



Główne cechy / Main features

Czytnik zbliżeniowy
Proximity tags reader



Częstotliwość: 125 kHz
Frequency: 125 kHz



Wbudowany szyfrator
Inbuilt code lock



Wodoodporny
Waterproof



Klawiatura dotykowa
Touch keypad



Symbol Product no.	EAN	Zasilanie Power supply	Stopień ochrony Protection rating	Maks. ilość użytkowników Max. number of users	Ilość wyjść przekaźnikowych Number of relay outputs	Obciążalność wyjść przekaźnikowych Relay output current	Wymiary (szer./wys./gł. [mm]) Dimensions (W/H/D [mm])
OR-ZS-824	5908254819605	12V DC	IP68	1000	1	3A	45 / 149 / 22

Zamki szyfrowe z czytnikiem kart i breloków zbliżeniowych
Code locks with card and proximity tags reader



OR-ZS-817

OR-ZS-818

Główne cechy / Main features

Czytnik zbliżeniowy
Proximity tags reader



Częstotliwość: 125 kHz
Frequency: 125 kHz



Wbudowany szyfrator
Inbuilt code lock



Wodoodporny
Waterproof



Symbol Product no.	EAN	Zasilanie Power supply	Stopień ochrony Protection rating	Maks. ilość użytkowników Max. number of users	Ilość wyjść przekaźnikowych Number of relay outputs	Obciążalność wyjść przekaźnikowych Relay output current	Wymiary (szer./wys./gł. [mm]) Dimensions (W/H/D [mm])
OR-ZS-817	5900378658337	12-24 VDC	IP66	999	2	2A / 2A	75 / 114,5 / 22
OR-ZS-818	5900378658344	12-24 VDC	IP66	999	2	2A / 2A	55,5 / 134 / 21

Zamek szyfrowy dotykowy, z czytnikiem kart i breloków zbliżeniowych oraz czytnikiem linii papilarnych
Code lock with touch keypad, proximity tags/cards reader and fingerprint reader

Główne cechy / Main features



Czytnik zbliżeniowy
Proximity tags reader



Częstotliwość: 125 kHz
Frequency: 125 kHz



Wbudowany szyfrator
Inbuilt code lock



Wodoodporny
Waterproof



Czytnik linii papilarnych
Fingerprint reader



Klawiatura dotykowa
Touch keypad



Symbol Product no.	EAN	Zasilanie Power supply	Stopień ochrony Protection rating	Maks. ilość użytkowników Max. number of users	Ilość wyjść przekaźnikowych Number of relay outputs	Obciążalność wyjść przekaźnikowych Relay output current	Wymiary (szer./wys./gt. [mm]) Dimensions (W/H/D [mm])
OR-ZS-822	5908254810275	12V DC	IP68	10000	1	3A	70 / 140 / 24

Zamek szyfrowy dotykowy, z czytnikiem kart i breloków zbliżeniowych oraz czytnikiem linii papilarnych
Code lock with touch keypad, proximity tags/cards reader and fingerprint reader

Główne cechy / Main features



Czytnik zbliżeniowy
Proximity tags reader



Częstotliwość: 125 kHz
Frequency: 125 kHz



Wbudowany szyfrator
Inbuilt code lock



Wodoodporny
Waterproof



Czytnik linii papilarnych
Fingerprint reader



Klawiatura dotykowa
Touch keypad



Symbol Product no.	EAN	Zasilanie Power supply	Stopień ochrony Protection rating	Maks. ilość użytkowników Max. number of users	Ilość wyjść przekaźnikowych Number of relay outputs	Obciążalność wyjść przekaźnikowych Relay output current	Wymiary (szer./wys./gt. [mm]) Dimensions (W/H/D [mm])
OR-ZS-825	5908254819612	12V DC	IP68	1000	1	3A	45 / 149 / 22

Zamek szyfrowy hermetyczny z czytnikiem kart i breloków zbliżeniowych oraz czytnikiem linii papilarnych
Code lock with digital keypad, proximity tags/cards reader and fingerprint reader



Główne cechy / Main features

Czytnik zbliżeniowy
Proximity tags reader



Częstotliwość: 125 kHz
Frequency: 125 kHz



Wbudowany szyfrator
Inbuilt code lock



Wodoodporny
Waterproof



Czytnik linii papilarnych
Fingerprint reader



Symbol Product no.	EAN	Zasilanie Power supply	Stopień ochrony Protection rating	Maks. ilość użytkowników Max. number of users	Ilość wyjść przekaźnikowych Number of relay outputs	Obciążalność wyjść przekaźnikowych Relay output current	Wymiary (szer./wys./gl. [mm]) Dimensions (W/H/D [mm])
OR-ZS-823	5908254810282	12V DC	IP68	10000	1	3A	70 / 140 / 24

Zamek szyfrowy hermetyczny z czytnikiem kart i breloków zbliżeniowych oraz czytnikiem linii papilarnych
Code lock with digital keypad, proximity tags/cards reader and fingerprint reader

Główne cechy / Main features

Powered by

tuya

Intelligence
Inside



Czytnik zbliżeniowy
Proximity tags reader



Częstotliwość: 125 kHz
Frequency: 125 kHz



Wbudowany szyfrator
Inbuilt code lock



Wodoodporny
Waterproof



Czytnik linii papilarnych
Fingerprint reader



Klawiatura dotykowa
Touch keypad



Standard komunikacji: Bluetooth 4.0
Communication protocol: Bluetooth 4.0



Symbol Product no.	EAN	Zasilanie Power supply	Stopień ochrony Protection rating	Maks. ilość użytkowników Max. number of users	Ilość wyjść przekaźnikowych Number of relay outputs	Obciążalność wyjść przekaźnikowych Relay output current	Wymiary (szer./wys./gl. [mm]) Dimensions (W/H/D [mm])
OR-ZS-826	5908254819629	12V DC	IP68	1000	1	3A	45 / 149 / 22

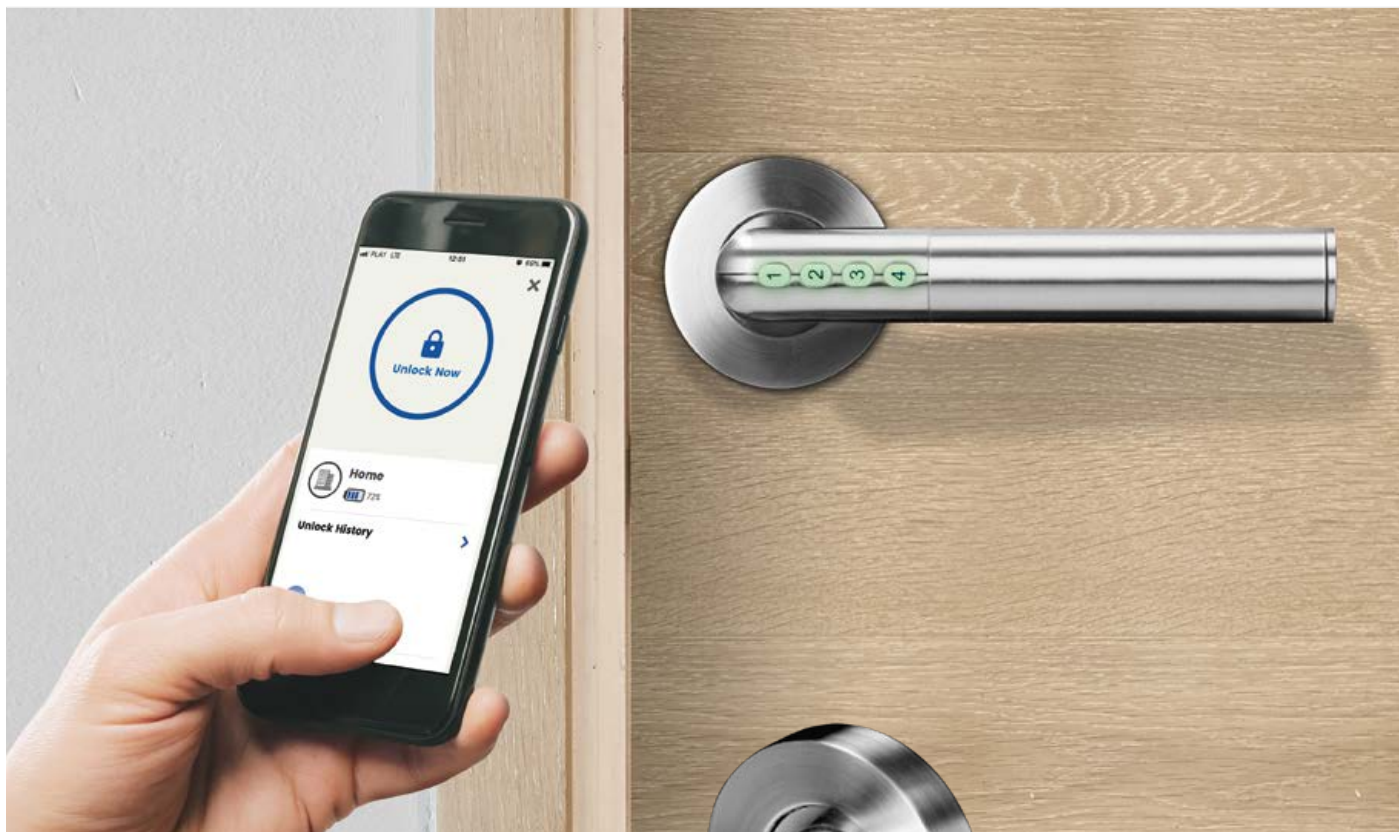

Klamka z zamkiem szyfrowym

Smart handle with code lock

Główne cechy / Main features

Odporna na warunki pogodowe
Weatherproof



Darmowa aplikacja
Free App



Możliwość nadawania dostępu stałego i tymczasowego
Temporary and permanent access can be granted



Standard komunikacji: Bluetooth 4.0
Communication protocol: Bluetooth 4.0



Materiał: stal nierdzewna
Material: stainless steel



Wbudowany szyfikator
Inbuilt code lock



Symbol Product no.	EAN	Zasilanie Power supply	Stopień ochrony Protection rating	Tryb pracy Working mode	Grubość drzwi [mm] Door thickness [mm]
OR-ZS-850	5908254802133	2xCR2	IP44	Bluetooth + kod Bluetooth + code	38-58



Wkładka szyfrowa z czytnikiem kart i breloków zbliżeniowych

Electronic cylinder with proximity tags and cards reader

Główne cechy / Main features



Darmowa aplikacja
Free App



Standard komunikacji: Mifare13,56 MHz
Communication protocol: Mifare 13,56 MHz



Wodoodporny
Waterproof



Możliwość nadawania dostępu stałego i tymczasowego
Temporary and permanent access can be granted



Materiał: stal nierdzewna
Material: stainless steel



Czytnik zbliżeniowy
Proximity tags reader

Symbol Product no.	EAN	Zasilanie Power supply	Stopień ochrony Protection rating	Tryb pracy Working mode	Długość wkładki [mm] Cylinder length [mm]
OR-ZS-851	5908254802713	CR123	IP65	brelok / brelok+karta / brelok lub Bluetooth proximity tag / proximity tag + card / proximity tag or Bluetooth	35/35
OR-ZS-852	5908254802720	CR123	IP65	brelok / brelok+karta / brelok lub Bluetooth proximity tag / proximity tag + card / proximity tag or Bluetooth	40/40

Przycisk wyjścia natynkowy, ABS

Surface mounted exit button, ABS

Materiał: tworzywo sztuczne
Material: plasticWymiary (szer./wys./gł. [mm]): 32 / 83 / 25
Dimensions (W/H/D [mm]): 32 / 83 / 25

Symbol Product no.	EAN	Obciążalność Load capacity	Styk Contact	Żywotność Lifetime	Stopień ochrony Protection rating	Kolor Color
OR-ZS-819	5908254801310	0.5A/36V DC	NO	500 000 cykli 500,000 cycles	IP20	biały white

**Przycisk wyjścia natynkowy**

Surface mounted exit button

Materiał: aluminium
Material: aluminiumWymiary (szer./wys./gł. [mm]): 32 / 83 / 25
Dimensions (W/H/D [mm]): 32 / 83 / 25

Symbol Product no.	EAN	Obciążalność Load capacity	Styk Contact	Żywotność Lifetime	Stopień ochrony Protection rating	Kolor Color	podświetlenie LED LED backlight
OR-ZS-813	5902560322996	3A/36V DC	NO	500 000 cykli 500,000 cycles	IP20	srebrny silver	○
OR-ZS-814	5902560323009	3A/36V DC	NO	500 000 cykli 500,000 cycles	IP20	srebrny silver	●

**Przycisk wyjścia bezdotykowy**

Touchless exit button

Materiał: aluminium + tworzywo sztuczne
Material: aluminium + plasticWymiary (szer./wys./gł. [mm]):
Przycisk: 70 / 115 / 9, Otwór montażowy: 43 / 55 / 29
Dimensions (W/H/D [mm]):
Button: 70 / 115 / 9, Mounting hole: 43 / 55 / 29

Symbol Product no.	EAN	Obciążalność Load capacity	Zasięg detekcji Range	Żywotność Lifetime	Stopień ochrony Protection rating	Kolor Color	Podświetlenie LED LED backlight
OR-ZS-812	5902560322989	3A/12-28V DC	0,1-10 cm	500 000 cykli 500,000 cycles	IP20	srebrno-czarny silver-black	●

**Karta zbliżeniowa**

Proximity card

Symbol Product no.	EAN	Częstotliwość Frequency	Standard komunikacji Communication protocol	Kolor Color	Wymiary (szer./wys./gł. [mm]) Dimensions (W/H/D [mm])
OR-ZS-892	5908254803574	125 kHz	EM	biały white	54 / 85 / 1
OR-ZS-893	5908254813214	13,56 MHz	Mifare	biały white	54 / 85 / 1

**Brelok zbliżeniowy**







Proximity tag









Symbol Product no.	EAN	Częstotliwość Frequency	Standard komunikacji Communication standard	Kolor Color	Wymiary (szer./wys./gł. [mm]) Dimensions (W/H/D [mm])
OR-ZS-890	5908254803321	125 kHz	EM	niebieski blue	28 / 60 / 5
OR-ZS-891	5908254803338	13,56 MHz	Mifare	niebieski blue	28 / 60 / 5



Kontrola dostępu

ACCESS CONTROL

						
Model Product no	OR-ZS-821	OR-ZS-820	OR-ZS-802	OR-ZS-815	OR-ZS-803	OR-ZS-816
EAN	5908254803383	5908254803376	5901752480414	5900378659457	5901752481008	5900378658320
Typ Type	Czytnik kart Card reader	Zamek szyfrowy Code lock	Zamek szyfrowy Code lock	Zamek szyfrowy Code lock	Zamek szyfrowy Code lock	Zamek szyfrowy dotykowy Touch code lock
Napięcie zasilania Power supply	12V DC	12V DC	12V DC	12V DC	12V DC	12V DC
Częstotliwość Frequency	125 kHz	125 kHz	125 kHz	125 kHz	125 kHz	125 kHz
Rodzaj transmisji Type of transmission	przewodowy wired	przewodowy wired	przewodowy wired	przewodowy wired	przewodowy wired	przewodowy wired
Ilość wyjść przekaźnikowych Number of relay outputs	1	1	1	1	1	1
Maks. ilość użytkowników Max. number of users	2000	1000	1000	1000	1000	2000
Czytnik zbliżeniowy Proximity reader	✓	✓	✓	✓	✓	✓
Szyfrator Code lock	×	✓	✓	✓	✓	✓
Stopień ochrony Protection rating	IP66	IP20	IP44	IP44	IP55	IP68
Wymiary (szer./wys./gł. [mm]) Dimensions (W/H/D [mm])	47 / 100 / 20	50 / 120 / 20	82 / 128 / 28	58 / 135 / 26mm	46 / 160 / 19	86 / 86 / 20
Obciążalność wyjść przekaźnikowych Relay output load	2A	3A	3A	3A	2A	3A
Ochrona antysabotażowa Anti-tamper protection	✓	✓	✓	✓	✓	×
Inne cechy Other features	Wytrzymała metalowa obudowa Durable metal housing	×	×	×	Dzwonek, Wąska obudowa Doorbell, Slim housing	Klawiatura dotykowa Touch keypad

							
OR-ZS-824	OR-ZS-817	OR-ZS-818	OR-ZS-804	OR-ZS-822	OR-ZS-825	OR-ZS-823	OR-ZS-826
5908254819605	5900378658337	5900378658344	5901752480407	5908254810275	5908254819612	5908254810282	5908254819629
Zamek szyfrowy dotykowy Touch code lock	Zamek szyfrowy Code lock	Zamek szyfrowy Code lock	Zamek szyfrowy Code lock	Zamek szyfrowy dotykowy Touch code lock	Zamek szyfrowy dotykowy Touch code lock	Zamek szyfrowy Code lock	Zamek szyfrowy dotykowy Touch code lock
12V DC	12V DC	12V DC	12V DC	12V DC	12V DC	12V DC	12V DC
125 kHz	125 kHz	125 kHz	125 kHz	125 kHz	125 kHz	125 kHz	125 kHz
przewodowy wired	przewodowy wired	przewodowy wired	przewodowy wired	przewodowy wired	przewodowy wired	przewodowy wired	przewodowy wired
1	2	2	2	1	1	1	1
1000	999	999	1200	10000	1000	10000	1000
✓	✓	✓	✓	✓	✓	✓	✓
✓	✓	✓	✓	✓	✓	✓	✓
IP68	IP66	IP66	IP68	IP68	IP68	IP68	IP68
45 / 149 / 22	75 / 114,5 / 22	134 / 55,5 / 21	58 / 135 / 26	70 / 140 / 24	45 / 149 / 22	70 / 140 / 24	45 / 149 / 22
3A	2A / 2A	2A / 2A	3A / 3A	3A	3A	3A	3A
✓	✓	✓	✓	✓	✓	✓	✓
Dzwonek, Wąska obudowa, Klawiatura dotykowa Doorbell, Slim housing, Touch keypad	Wytrzymała metalowa obudowa Durable metal housing	Wytrzymała metalowa obudowa Durable metal housing	×	Dzwonek, Czytnik linii papilarnych, Klawiatura dotykowa Doorbell, Fingerprint reader, Touch keypad	Czytnik linii papilarnych, Wąska obudowa, Klawiatura dotykowa Fingerprint reader, Slim housing, Touch keypad	Czytnik linii papilarnych, Wytrzymała metalowa obudowa Fingerprint reader Durable metal housing	Czytnik linii papilarnych, Wąska obudowa, Klawiatura dotykowa, aplikacja Tuya, Bluetooth 4.0 Fingerprint reader, Slim housing, Touch keypad, powered by Tuya

NOWOCZESNE ELEKTROZACZEPY

MODERN ELECTRIC STRIKES



Brak polaryzacji

nieważne jak podłączysz, zawsze działa

No polarity

regardless of the connection, it always works the same

Pogłębione przyłącze

zmniejsza ryzyko zwarcia

Bigger terminal

reduces the risk of short circuit

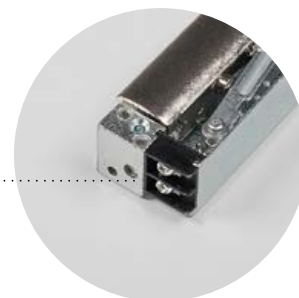

Elektrozaczepy symetryczne niskoprądowe o uniwersalnym napięciu zasilania

Symmetric electric strikes with low current coil and universal voltage

Nie przegrzeje się

cewka z zabezpieczeniem termicznym

No overheating

coil with thermal protection

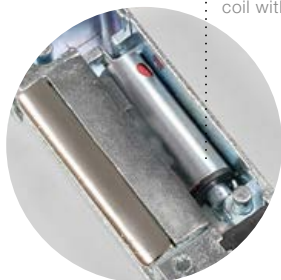

Pasuje do każdych drzwi

symetryczna budowa i innowacyjna regulacja zapadki

Suitable for all door types

symmetric construction and innovative latch adjustment

STANDARD

MINI



Do cienkich drzwi aluminiowych i drewnianych

zapadka porusza się wokół własnej osi

Suitable for thin aluminium and wooden doors

keeper rotates on its own axis

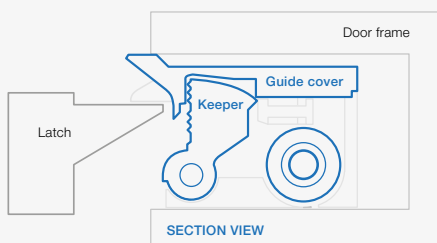

Płynna praca

dzięki prowadnicy języka klamki





Smooth sliding

through latch guide





TABELA PORÓWNAWCZA
ELEKTROZACZEPY







COMPARISON TABLE
ELECTRIC STRIKES

	Symbol Product no.	EAN	Zasilanie Power supply	Pobór prądu podczas pracy Power consumption during operation	Wymiary (szer./wys./gt. [mm]) Dimensions (width x height x depth [mm])	Kierunek otwierania Direction of opening	Regulacja zapadki Latch adjustment	Rozmiar MINI Mini size	Prowadnica Latch guide	Blokada Mechanical unlocking	Pamięć Memory	Sygnalizacja niedomkniętych drzwi Door-open indication	Rewersyjny Fail-safe lock
	OR-EZ-4013	5901752483699	8-14 V AC/DC	1000 mA/ 12VDC	20,7 / 90 / 28	lewy left	<input type="radio"/>	<input type="radio"/>	<input type="radio"/>	<input type="radio"/>	<input type="radio"/>	<input type="radio"/>	<input type="radio"/>
	OR-EZ-4009	5901752483651	8-14 V AC/DC	1000 mA/ 12VDC	20,7 / 90 / 28	lewy left	<input type="radio"/>	<input type="radio"/>	<input type="radio"/>	<input checked="" type="radio"/>	<input type="radio"/>	<input type="radio"/>	<input type="radio"/>
	OR-EZ-4007	5901752483637	8-14 V AC/DC	1000 mA/ 12VDC	20,7 / 90 / 28	lewy left	<input type="radio"/>	<input type="radio"/>	<input type="radio"/>	<input type="radio"/>	<input checked="" type="radio"/>	<input type="radio"/>	<input type="radio"/>
	OR-EZ-4011	5901752483675	8-14 V AC/DC	1000 mA/ 12VDC	20,7 / 90 / 28	lewy left	<input type="radio"/>	<input type="radio"/>	<input type="radio"/>	<input checked="" type="radio"/>	<input checked="" type="radio"/>	<input type="radio"/>	<input type="radio"/>
	OR-EZ-4014	5901752483705	8-14 V AC/DC	1000 mA/ 12VDC	20,7 / 90 / 28	prawy right	<input type="radio"/>	<input type="radio"/>	<input type="radio"/>	<input type="radio"/>	<input type="radio"/>	<input type="radio"/>	<input type="radio"/>
	OR-EZ-4010	5901752483668	8-14 V AC/DC	1000 mA/ 12VDC	20,7 / 90 / 28	prawy right	<input type="radio"/>	<input type="radio"/>	<input type="radio"/>	<input checked="" type="radio"/>	<input type="radio"/>	<input type="radio"/>	<input type="radio"/>
	OR-EZ-4008	5901752483644	8-14 V AC/DC	1000 mA/ 12VDC	20,7 / 90 / 28	prawy right	<input type="radio"/>	<input type="radio"/>	<input type="radio"/>	<input type="radio"/>	<input checked="" type="radio"/>	<input type="radio"/>	<input type="radio"/>
	OR-EZ-4012	5901752483682	8-14 V AC/DC	1000 mA/ 12VDC	20,7 / 90 / 28	prawy right	<input type="radio"/>	<input type="radio"/>	<input type="radio"/>	<input checked="" type="radio"/>	<input checked="" type="radio"/>	<input type="radio"/>	<input type="radio"/>
	OR-EZ-4030	5908254803970	10-24 V AC/DC	290mA / 12VDC	21 / 69 / 29	prawy/lewy right/left	<input checked="" type="radio"/>	<input type="radio"/>	<input type="radio"/>	<input type="radio"/>	<input checked="" type="radio"/>	<input type="radio"/>	<input type="radio"/>
	OR-EZ-4031	5908254803963	10-24 V AC/DC	290mA / 12VDC	21 / 69 / 29	prawy/lewy right/left	<input checked="" type="radio"/>	<input type="radio"/>	<input type="radio"/>	<input checked="" type="radio"/>	<input type="radio"/>	<input type="radio"/>	<input type="radio"/>
	OR-EZ-4032	5908254803987	10-24 V AC/DC	290mA / 12VDC	21 / 69 / 29	prawy/lewy right/left	<input checked="" type="radio"/>	<input type="radio"/>	<input type="radio"/>	<input checked="" type="radio"/>	<input checked="" type="radio"/>	<input type="radio"/>	<input type="radio"/>
	OR-EZ-4033	5908254803956	10-24 V AC/DC	290mA / 12VDC	21 / 69 / 29	prawy/lewy right/left	<input checked="" type="radio"/>	<input type="radio"/>	<input type="radio"/>	<input type="radio"/>	<input type="radio"/>	<input type="radio"/>	<input type="radio"/>
	OR-EZ-4024	5908254803994	9-24V AC/DC	290mA / 12VDC	16 / 65,6 / 28,1	prawy/lewy right/left	<input checked="" type="radio"/>	<input checked="" type="radio"/>	<input type="radio"/>	<input type="radio"/>	<input type="radio"/>	<input type="radio"/>	<input type="radio"/>
	OR-EZ-4025	5908254804007	9-24V AC/DC	290mA / 12VDC	16 / 65,6 / 28,1	prawy/lewy right/left	<input checked="" type="radio"/>	<input checked="" type="radio"/>	<input type="radio"/>	<input checked="" type="radio"/>	<input type="radio"/>	<input type="radio"/>	<input type="radio"/>
	OR-EZ-4026	5908254804014	9-24V AC/DC	290mA / 12VDC	16 / 65,6 / 28,1	prawy/lewy right/left	<input checked="" type="radio"/>	<input checked="" type="radio"/>	<input type="radio"/>	<input type="radio"/>	<input checked="" type="radio"/>	<input type="radio"/>	<input type="radio"/>
	OR-EZ-4027	5908254804021	9-24V AC/DC	290mA / 12VDC	16 / 65,6 / 28,1	prawy/lewy right/left	<input checked="" type="radio"/>	<input checked="" type="radio"/>	<input type="radio"/>	<input checked="" type="radio"/>	<input checked="" type="radio"/>	<input type="radio"/>	<input type="radio"/>
	OR-EZ-4028	5908254804038	9-24V AC/DC	290mA / 12VDC	16 / 65,6 / 28,1	prawy/lewy right/left	<input checked="" type="radio"/>	<input checked="" type="radio"/>	<input type="radio"/>	<input type="radio"/>	<input type="radio"/>	<input type="radio"/>	<input checked="" type="radio"/>
	OR-EZ-4029	5908254804045	9-24V AC/DC	290mA / 12VDC	16 / 72,7 / 28,1	prawy/lewy right/left	<input checked="" type="radio"/>	<input checked="" type="radio"/>	<input type="radio"/>	<input type="radio"/>	<input type="radio"/>	<input checked="" type="radio"/>	<input type="radio"/>
	OR-EZ-4034	5908254804052	9-24V AC/DC	290mA / 12VDC	17,7 / 65,6 / 28,1	prawy/lewy right/left	<input checked="" type="radio"/>	<input checked="" type="radio"/>	<input checked="" type="radio"/>	<input type="radio"/>	<input type="radio"/>	<input type="radio"/>	<input type="radio"/>
	OR-EZ-4035	5908254804069	9-24V AC/DC	290mA / 12VDC	17,7 / 65,6 / 28,1	prawy/lewy right/left	<input checked="" type="radio"/>	<input checked="" type="radio"/>	<input checked="" type="radio"/>	<input checked="" type="radio"/>	<input type="radio"/>	<input type="radio"/>	<input type="radio"/>
	OR-EZ-4038	5908254809996	9-24V AC/DC	290mA / 12VDC	17,7 / 65,6 / 28,1	prawy/lewy right/left	<input checked="" type="radio"/>	<input checked="" type="radio"/>	<input checked="" type="radio"/>	<input type="radio"/>	<input type="radio"/>	<input checked="" type="radio"/>	<input type="radio"/>
	OR-EZ-4036	5908254804076	9-24V AC/DC	290mA / 12VDC	17,7 / 65,6 / 28,1	prawy/lewy right/left	<input checked="" type="radio"/>	<input checked="" type="radio"/>	<input checked="" type="radio"/>	<input type="radio"/>	<input type="radio"/>	<input type="radio"/>	<input checked="" type="radio"/>
	OR-EZ-4037	5908254804083	9-24V AC/DC	290mA / 12VDC	21,2 / 65,6 / 28,1	prawy/lewy right/left	<input checked="" type="radio"/>	<input checked="" type="radio"/>	<input checked="" type="radio"/>	<input type="radio"/>	<input type="radio"/>	<input checked="" type="radio"/>	<input checked="" type="radio"/>

Szyldy dedykowane dla elektrozaczepów lewych, prawych, symetrycznych
Faceplates for left, right and symmetrical electric door strikes

	Symbol Product no.	EAN	Kierunek otwierania Direction of opening	Wymiary (szer./wys./gl. [mm]) Dimensions (W/H/D [mm])	Inne cechy Other features
	OR-EZ-01	5901752489936	prawy/lewy right/left	25 / 159 / 3	niklowany nickel-plated
	OR-EZ-02	5901752489943	prawy/lewy right/left	25 / 110 / 3	niklowany nickel-plated
	OR-EZ-03	5900378651017	prawy/lewy right/left	25 / 250 / 3	malowany painted

Szyldy dedykowane dla elektrozaczepów MINI
Faceplates for MINI electric door strikes

	Symbol Product no.	EAN	Kierunek otwierania Direction of opening	Wymiary (szer./wys./gl. [mm]) Dimensions (W/H/D [mm])	Inne cechy Other features
	OR-EZ-4001SK1	5901752481466	prawy/lewy right/left	22 / 130 / 3	INOX
	OR-EZ-4001SD1	5901752481480	prawy/lewy right/left	22 / 250 / 3	INOX
	OR-EZ-4001SDL2	5901752481473	lewy left	24 / 243,9 / 3	INOX
	OR-EZ-4001SDP1	5901752481831	prawy right	24 / 243,9 / 3	INOX
	OR-EZ-4001SRL2	5901752481503	lewy left	32,5 / 227,5 / 2	INOX, kątowny INOX, angled
	OR-EZ-4001SRP1	5901752481497	prawy right	32,5 / 227,5 / 2	INOX, kątowny INOX, angled

MINI ALARMY

MINI ALARMS



Bezprzewodowy alarm z sygnalizacją dźwiękową i świetlną

WIRELESS DRIVEWAY ALERT SYSTEM WITH SOUND AND LIGHT ALARM

Główne cechy / Main features



Regulacja głośności
Volume adjustment



Możliwość rozbudowy
Possibility of extension



Sygnalizacja optyczna
Optical indication



Opcja zastosowania zasilacza 5VDC (centrala)
Possibility of using a 5VDC power supply (receiver)

	Symbol Product no.	EAN
Czujnik ruchu z centralą Motion sensor with receiver	OR-MA-716	5908254805585
Czujnik ruchu do rozbudowy OR-MA-716 Additional motion sensor for OR-MA-716	OR-MA-716CR	5908254805745

Centrala / Receiver

Częstotliwość Frequency	Zasięg Range	Zasilanie Power supply	Ilość stref detekcji No. of detection zones	Maks. ilość czujników Max. no. of sensors	Dźwięki alarmu Alarm sound	Poziom głośności (dB) Alarm volume (dB)	Wymiary (szer./wys./gt. [mm]) Dimensions (W/H/D [mm])
433 MHz	300m	3 x AA / zasilacz 5VDC 3 x AA / power supply 5VDC	4	16	35	max. 80	105 / 105 / 39

Czujnik ruchu / Motion sensor

Częstotliwość Frequency	Zasięg detekcji Motion detection range	Zasilanie Power supply	Stopień ochrony Protection rating	Wymiary (szer./wys./gt. [mm]) Dimensions (W/H/D [mm])
433 MHz	8m	3 x AAA	IP44	60 / 130 / 52

Czujnik ruchu z sygnalizacją i z alarmem DING-DONG Motion sensor with DING-DONG signalling and alarm



Główne cechy / Main features



Opcja zastosowania zasilacza 6VDC
Possibility of using a 6VDC power supply



Odbiornik (szer./wys./gł. [mm]): 70 / 110 / 47
Receiver (W/H/D [mm]): 70 / 110 / 47

Symbol Product no.	EAN	Zasilanie odbiornika Power supply of the receiver	Zasięg Range	Kąt Angle	Dźwięki alarmu Alarm sound	Poziom głośności (dB) Alarm volume (dB)	Stopień ochrony Protection rating
OR-MA-701	5908235905075	4 x AA	6m	100°	36	110	IP20

Bezprzewodowy alarm z sygnalizacją dźwiękową i świetlną Wireless driveway alert system with sound and light alarm

Główne cechy / Main features



Funkcja learning system
Learning system



Sygnalizacja optyczna
Optical indication



Opcja zastosowania zasilacza 5VDC
Possibility of using a 5VDC power supply



Wymiary (szer./wys./gł. [mm]):
Odbiornik: 92 / 128 / 41, Nadajnik: 68 / 105 / 4
Dimensions (W/H/D [mm]):
Receiver: 92 / 128 / 41, Transmitter: 68 / 105 / 4



Symbol Product no.	EAN	Zasilanie odbiornika Power supply of the receiver	Częstotliwość Frequency	Moc maks. nadajnika Transmitter max. power	Zasięg Range	Kąt Angle	Dźwięki alarmu Alarm sound	Poziom głośności (dB) Alarm volume (dB)	Stopień ochrony Protection rating	Napięcie zasilania nadajnika Power supply of the transmitter	Czujniki Sensors
OR-MA-705	5901752482470	3 x LR14	433 MHz	< 10mW	120m	45°	2	95	IP44	3 x AAA	1
OR-MA-710	5901752486027	3 x LR14	433 MHz	< 10mW	120m	45°	2	95	IP44	3 x AAA	2

Alarm bezprzewodowy z wbudowaną syreną, sterowany pilotem

Wireless mini alarm with built-in siren and remote control



Główne cechy / Main features

Rodzaj transmisji: IR
Type of transmission: IR



Możliwość rozbudowy
Possibility of extension



	Symbol Product no.	EAN
Alarm z pilotem Alarm with remote control	OR-MA-711	5901752486041
Pilot do rozbudowy alarmu OR-MA-711 Additional remote control for OR-MA-711	OR-MA-711PB	5901752487086

Alarm / Alarm

Zasilanie Power supply	Zasięg Range	Kąt Angle	Dźwięki alarmu Alarm sound	Poziom głośności (dB) Alarm volume (dB)	Wymiary (szer./wys./gł. [mm]) Dimensions (W/H/D [mm])
3 x AA	6m	100°	1	100	105 / 105 / 39

Pilot / Remote control

Zasilanie Power supply	Stopień ochrony Protection rating	Kolor Color	Wymiary (szer./wys./gł. [mm]) Dimensions (W/H/D [mm])
1 x CR2032	IP20	biały white	33 / 61 / 30

Alarm bezprzewodowy z wbudowaną syreną i sygnalizatorem świetlnym sterowany pilotem

Wireless mini alarm with built-in siren, light and remote control



Główne cechy / Main features

Rodzaj transmisji: IR
Type of transmission: IR



Sygnalizacja optyczna (70lm / 15 sek.)
Optical indication (70lm / 15 sec.)



Wymiary (szer./wys./gł. [mm]): 55,6 / 78,7 / 160,4
Dimensions (W/H/D [mm]): 55,6 / 78,7 / 160,4





Symbol Product no.	EAN	Zasilanie Power supply	Zasięg Range	Kąt Angle	Dźwięki alarmu Alarm sound	Poziom głośności (dB) Alarm volume (dB)	Stopień ochrony Protection rating	Napięcie zasilania nadajnika Power supply of the transmitter
OR-MA-715	5900378655763	4xAA	5m +/- 1m	120°	1	90	IP44	1x3V CR2032

System alarmowy bezprzewodowy MH z modułem GSM Wireless alarm system MH with GSM module

Główne cechy / Main features

-  Moduł GSM
GSM module

-  Funkcja learning system
Learning system

-  Sygnalizacja niskiego stanu baterii
Low battery indication

-  Możliwość rozbudowy
Possibility of extension



Symbol Product no.	EAN	Częstotliwość Frequency	Zasilanie Power supply	Zasięg Range	Poziom głośności (dB) Alarm volume (dB)	Wymiary (szer./wys./gl. [mm]) Dimensions (W/H/D [mm])
OR-AB-MH-3005	5901752482890	868 MHz	3 x AA	80m	120	70 / 112 / 38

Akcesoria do systemu MH: / Accessories for MH system:

Pilot zdalnego sterowania do alarmu MH Remote control for MH alarm

Symbol Product no.	EAN	Zasilanie Power supply	Zasięg Range	Częstotliwość Frequency	Wymiary (szer./wys./gl. [mm]) Dimensions (W/H/D [mm])
OR-AB-MH-3005PB	5901752482937	1 x CR2032	80m	868 MHz	43 / 76 / 13



Czujnik ruchu bezprzewodowy do alarmu MH Wireless motion sensor for MH alarm

-  Funkcja learning system
Learning system

-  Sygnalizacja niskiego stanu baterii
Low battery indication

-  Możliwość rozbudowy
Possibility of extension



Symbol Product no.	EAN	Częstotliwość Frequency	Zasilanie Power supply	Zasięg Range	Wymiary (szer./wys./gl. [mm]) Dimensions (W/H/D [mm])
OR-AB-MH-3005CR	5901752482913	868 MHz	3 x AA	80m	70 / 112 / 38

ATRAPY KAMER CCTV

DUMMY SECURITY CCTV CAMERA



Atrapa obrotowej kamery CCTV

Dummy security rotating CCTV camera

Główne cechy / Main features

Stopień ochrony: IP44
Protection rating : IP44



Mrugająca czerwona dioda
Flashing red diode



Realistyczny wygląd kamery obrotowej PTZ
Realistic PTZ camera design



Zasilanie bateryjne (2 x AA)
Battery powered (2 x AA)



Symbol Product no.	EAN	Zasilanie Power supply	Kolor Color	Wymiary kamery (szer./wys./gi. [mm]) Dim. of the camera (W/H/D [mm])	Wym. bazy montażowej (szer./wys./gi. [mm]) Dim. of the mounting base (W/H/D [mm])
OR-AK-1212	5908254821516	2 x AA	biały white	Ø130 / 240	-



OR-AK-1211



Mrugająca czerwona dioda
Flashing red diode



OR-AK-1210



Mrugająca czerwona dioda
Flashing red diode



OR-AK-1209



Mrugająca czerwona dioda
Flashing red diode



IP44

OR-AK-1208/G



Mrugająca czerwona dioda
Flashing red diode



IP44

OR-AK-1208/B



Mrugająca czerwona dioda
Flashing red diode



IP44

OR-AK-1207/G



Mrugająca czerwona dioda
Flashing red diode



Panel solarny
Solar panel

Symbol Product no.	EAN	Zasilanie Power supply	Kolor Color	Wymiary kamery (szer./wys./gt. [mm]) Dim. of the camera (W/H/D [mm])	Wym. bazy montażowej (szer./wys./gt. [mm]) Dim. of the mounting base (W/H/D [mm])
OR-AK-1211	5908254803789	3 x AAA	czarny black	Ø99,5 / 72	-
OR-AK-1210	5908254803796	3 x AA	biały white	Ø125 / 90	-
OR-AK-1209	5908254803802	2 x AA	biały white	Ø128 / 100	-
OR-AK-1208/G	5908254803697	2 x AA	srebrny silver	169 / Ø70	80 / 80 / 124
OR-AK-1208/B	5908254801631	2 x AA	czarny black	169 / Ø70	80 / 80 / 124
OR-AK-1207/G	5908254801624	2 x AA	srebrny silver	178 / Ø70	80 / 80 / 124

Chroń swoją RODZINĘ

Protect your
FAMILY

Baterijny czujnik tlenku węgla (czadu)

Battery operated carbon monoxide detector



Bezpieczeństwo

www.tuv.com
ID 0000044729



produkt testowany w Polsce
product tested in Poland

Główne cechy / Main features



Bateria w zestawie
Battery included



Przycisk test
Test button



Wyciszenie alarmu
Hush button



Sygnalizacja niskiego stanu baterii
Low battery indication



Sygnalizacja awarii
Failure indication



Sygnalizacja końca okresu eksploatacji
End of life indication



Funkcja pamięci
Memory function

Symbol Product no.	EAN	Zasilanie Power supply	Typ czujnika Type of sensor	Poziom głośności (dB) Alarm volume (dB)	Żywotność Life time	Spełnione normy Compliance with standards	Wymiary (szer./wys./gł. [mm]) Dimensions (W/H/D [mm])
OR-DC-619-TEST	5901752486065	3 x AA	elektrochemiczny electrochemical	85/1m	7 lat 7 years	EN 50291-1:2010/A1:2012	122 / 77 / 35

Baterijne czujniki dymu

Battery operated smoke detectors

Główne cechy / Main features



Bateria w zestawie
Battery included



Przycisk test
Test button



Sygnalizacja niskiego stanu baterii
Low battery indication



Symbol Product no.	EAN	Zasilanie Power supply	Typ czujnika Type of sensor	Poziom głośności (dB) Alarm volume (dB)	Żywotność Life time	Spełniane normy Compliance with standards	Wymiary (szer./wys./gł. [mm]) Dimensions (W/H/D [mm])
OR-DC-609	5901752481817	1 x 9V	fotoelektryczny photoelectric	≥85/3m	10 lat 10 years	EN 14604:2005/AC1:2008	Ø107 / 35

Baterijne czujniki dymu

Battery operated smoke detectors

Główne cechy / Main features



Bateria w zestawie
Battery included



Przycisk test
Test button



Sygnalizacja niskiego stanu baterii
Low battery indication

certyfi kat BSI
BSI certificate



KM514007



Symbol Product no.	EAN	Zasilanie Power supply	Typ czujnika Type of sensor	Poziom głośności (dB) Alarm volume (dB)	Żywotność Life time	Spełniane normy Compliance with standards	Wymiary (szer./wys./gł. [mm]) Dimensions (W/H/D [mm])
OR-DC-630	5900378654537	1 x 9V	fotoelektryczny photoelectric	≥85/3m	10 lat 10 years	EN 14604:2005/AC1:2008	Ø107 / 27

OR-DC-622

Magnetyczna płytki montażowa
do detektorów dymu i czadu

Magnetic mounting plate
for smoke and carbon monoxide detectors





Baterijny czujnik dymu MINI ze zintegrowaną baterią

MINI smoke detector with built-in lithium battery

certyfiakat BSI
BSI certificate



KM514007



Główne cechy / Main features



Zintegrowane, dożywotnie zasilanie
Integrated, lifelong power supply



Sygnalizacja niskiego stanu baterii
Low battery indication



Przycisk test
Test button



Sygnalizacja awarii
Failure indication



Wyciszenie alarmu
Hush button





Sygnalizacja końca okresu eksploatacji
End of life indication

Symbol Product no.	EAN	Zasilanie Power supply	Typ czujnika Type of sensor	Poziom głośności (dB) Alarm volume (dB)	Żywotność Life time	Spełniane normy Compliance with standards	Wymiary (szer./wys./gt. [mm]) Dimensions (W/H/D [mm])
OR-DC-628	5902560329223	zintegrowane integrated	fotoelektryczny photoelectric	≥85/3m	10 lat 10 years	EN 14604:2005/AC1:2008	Ø45 / 42

Baterijny czujnik dymu papierosowego Battery operated cigarette smoke detector

Główne cechy / Main features

-  Bateria w zestawie
Battery included

-  Przycisk test
Test button

-  Wyciszenie alarmu
Hush button

-  Sygnalizacja niskiego stanu baterii
Low battery indication



Symbol Product no.	EAN	Zasilanie Power supply	Typ czujnika Type of sensor	Poziom głośności (dB) Alarm volume (dB)	Żywotność Life time	Wymiary (szer./wys./gł. [mm]) Dimensions (W/H/D [mm])
OR-DC-623	5901752484474	1 x 9V	fotoelektryczny photoelectric	≥85/3m	10 lat 10 years	Ø107 / 35

Czujnik gazu ziemnego, sieciowy z wyjściem przekaźnikowym Natural gas detector, mains operated with relay output

Główne cechy / Main features

-  Przycisk test
Test button

-  Sygnalizacja awarii
Failure indication

-  Sygnalizacja końca okresu eksploatacji
End of life indication

-  Wyjście przekaźnikowe
Relay output

-  Funkcja zamykania zaworu
Valve closing function



Symbol Product no.	EAN	Zasilanie Power supply	Typ czujnika Type of sensor	Poziom głośności (dB) Alarm volume (dB)	Żywotność Life time	Spełniane normy Compliance with standards	Wymiary (szer./wys./gł. [mm]) Dimensions (W/H/D [mm])
OR-DC-614	5901752482258	230V~, 50Hz	elektrochemiczny electrochemical	≥70	5 lat 5 years	EN 50194-1:2009	82 / 125 / 41



CNG

Czujnik gazu ziemnego
Natural gas sensor

Główne cechy / Main features

Przycisk test
Test button



Sygnalizacja awarii
Failure indication



Sygnalizacja końca okresu eksploatacji
End of life indication



Symbol Product no.	EAN	Zasilanie Power supply	Typ czujnika Type of sensor	Poziom głośności (dB) Alarm volume (dB)	Żywotność Life time	Spełniane normy Compliance with standards	Wymiary (szer./wys./gł. [mm]) Dimensions (W/H/D [mm])
OR-DC-632	5908254817250	230V~, 50Hz	elektrochemiczny electrochemical	≥85	5 lat 5 years	EN 50194-1:2009	102 / 170 / 51



LPG

Czujnik gazu LPG
LPG gas detector

Główne cechy / Main features

Przycisk test
Test button



Sygnalizacja awarii
Failure indication



Sygnalizacja końca okresu eksploatacji
End of life indication



Symbol Product no.	EAN	Zasilanie Power supply	Typ czujnika Type of sensor	Poziom głośności (dB) Alarm volume (dB)	Żywotność Life time	Spełniane normy Compliance with standards	Wymiary (szer./wys./gł. [mm]) Dimensions (W/H/D [mm])
OR-DC-631	5908254804663	230V~, 50Hz	elektrochemiczny electrochemical	≥85	5 lat 5 years	EN50194-1:2009	102 / 170 / 51



Baterijny czujnik zalania
Battery operated water leak detector

Główne cechy / Main features

Przycisk test
Test button



Sygnalizacja niskiego stanu baterii
Low battery indication



Regulacja głośności
Volume adjustment



Symbol Product no.	EAN	Zasilanie Power supply	Typ czujnika Type of sensor	Poziom głośności (dB) Alarm volume (dB)	Wymiary (szer./wys./gł. [mm]) Dimensions (W/H/D [mm])
OR-DC-629	5900378650768	3 x AAA	sonda magnetyczna magnetic probe	95 - 110	46 / 122 / 18

CZUJNIKI RUCHU

MOTION SENSORS

Czujnik ruchu PIR 360°

PIR motion sensor 360°



Główne cechy / Main features



Czujnik obecności
Presence sensor



Stopień ochrony: IP65
Protection rating : IP65



Zasięg detekcji: Ø20m
Detection range: Ø20m



Regulacja czasu świecenia TIME
Adjustment of lighting time (TIME)













Regulacja natężenia światła LUX
Adjustment of light intensity (LUX)













Symbol Product no.	EAN	Zasilanie Power supply	Maks. obciążenie Max. load	Montaż Installation	Kolor Color	Wymiary (szer./wys./gl. [mm]) Dimensions (W/H/D [mm])
OR-CR-259/W	5900378653370	230V~, 50Hz	2000W	natynkowy surface mounting	biały white	172,5 / 56 / 86,5
OR-CR-259/B	5900378653387	230V~, 50Hz	2000W	natynkowy surface mounting	czarny black	172,5 / 56 / 86,5





TABELA PORÓWNAWCZA
CZUJNIKÓW RUCHU

COMPARISON TABLE
MOTION SENSORS

Sufitowe CEILING MOUNTED						
Model Product no		OR-CR-203/W	OR-CR-203/B	OR-CR-263	OR-CR-249	OR-CR-258
EAN		5908235905211	5908235905174	5900378654773	5902560321432	5900378650270
Kąt detekcji Detection angle		360°	360°	360°	360°	360°
Zasięg detekcji Motion detection RANGE		Ø6m	Ø6m	Ø8m	Ø6m	Ø8m
Napięcie zasilania Power supply		230V~, 50Hz	230V~, 50Hz	230V~, 50Hz	230V~, 50Hz	230V~, 50Hz
Maks. obciążenie / obciążenie LED Max. load / LED load		1200W / 300W	1200W / 300W	400W / 100W	1200W / 300W	800W / 200W
Czujnik obecności Presence sensor		x	x	x	x	x
LUX Zakres regulacji Adjustment range		<3—2000 lux	<3—2000 lux	<3—2000 lux	<3—2000 lux	<3—2000 lux
TIME Zakres regulacji Adjustment range		10 sek. - 7 min.	10 sek. - 7 min.	10 sek. - 7 min.	10 sek. - 15 min.	10 sek. - 15 min.
Regulacja zasięgu detekcji SENS Adjustment of the range of motion detection (SENS)		x	x	x	x	x
Wymiary czujnika (szer./wys./gt. [mm]) Dimensions of the sensor (W/H/D [mm])		Ø115 / 58	Ø115 / 58	Ø76x20,2	Ø80 / 41	Ø102 x 24,9
Wymiary otworu montażowego ([mm]) Dimensions of the mounting hole ([mm])		x	x	x	x	x
Inne cechy Other features		x	x	MINI	MINI	ultra płaski (ultra flat) MINI
Ścienne Wall mounted						
Model Product no		OR-CR-201/W	OR-CR-201/B	OR-CR-204/W	OR-CR-204/B	OR-CR-256
EAN		5908235905198	5908235905150	5901752481077	5901752481060	5900378650232
Kąt detekcji Detection angle		180°		180°	360°/180°	
Zasięg detekcji Motion detection range		12m		12m	12m	
Napięcie zasilania Power supply		230V~, 50Hz		230V~, 50Hz	230V~, 50Hz	
Maks. obciążenie / obciążenie LED Max. load / LED load		1200W / 300W		1200W / 300W	800W / 200W	
Stopień ochrony Protection rating		IP44		IP44	IP65	
LUX Zakres regulacji Adjustment range		<3—2000lux		<3—2000lux	<3—2000lux	
TIME Zakres regulacji adjustment range		10 sek. - 7 min.		10 sek. - 12 min.	10 sek. - 15 min.	
Montaż Installation		natynkowy surface mounting		natynkowy surface mounting	natynkowy surface mounting	
Wymiary (szer./wys./gt. [mm]) Dimensions (W / H / D [mm])		87 / 60 / 93		85 / 92 / 64	Ø90 x 71,6	
Inne cechy Other features		x		x	x	



						 IP65
OR-CR-241	OR-CR-250	OR-CR-252	OR-CR-253	OR-CR-247	OR-CR-224	OR-CR-264
5901752485082	5902560321456	5902560325805	5902560325829	5901752487475	5901752483057	5900378654780
360°	360°	360°	360°	360°	360°	360°
Ø6m	Ø8m	Ø3m-16m	Ø3m-20m	Ø4m x 20m	Ø20m	Ø8m
230V~, 50Hz	230V~, 50Hz	230V~, 50Hz	230V~, 50Hz	230V~, 50Hz	230V~, 50Hz	230V~, 50Hz
2000W / 500W	800W / 200W	2000W / 500W	2000W / 500W	2000W / 500W	2000W / 500W	2000W / 500W
×	×	×	✓	×	✓	×
<3—2000 lux	<3—2000 lux	<3—2000 lux	<3—2000 lux	<3—2000 lux	<3—2000 lux	<3—2000 lux
10 sek. - 15 min.	10 sek. - 15 min.	10 sek. - 30 min.	10 sek. - 30 min.	10 sek. - 30 min.	10 sek. - 30 min.	10 sek. - 15 min.
×	×	✓	✓	×	×	×
Ø115 / 24,3	Ø115 / 55	Ø120 / 46,5	Ø120 / 51,8	102,5 / 102,5 / 58,3	102,5 / 102,5 / 58,3	Ø110x27
×	×	×	×	×	×	×
ultra płaski (ultra flat)	×	3 sensory (3 sensors), regulacja zasięgu (adjustment range)	3 sensory (3 sensors), regulacja zasięgu (adjustment range)	korytarzowa (hallway function)	3 sensory (3 sensors)	×
 IP65	 IP65	 IP44	 IP44	 IP44	 DWA CZUJNIKI TWO SENSORS	 IP65
OR-CR-236/W	OR-CR-236/B	OR-CR-242	OR-CR-262/W	OR-CR-262/B	OR-CR-254/W	OR-CR-254/B
5901752484634	5901752486737	5901752485099	5900378654759	5900378654766	5902560328080	5902560328103
180°		180°		220°		360st / 180°
12m		15m		12m		12m
230V~, 50Hz		230V~, 50Hz		230V~, 50Hz		230V~, 50Hz
1200W / 300W		800W / 200W		1200W / 300W		1200W / 300W
IP65		IP44		IP44		IP65
<3—2000lux		<3—2000lux		<3—2000lux		<3—2000lux
10 sek. - 7 min.		10 sek. - 15 min.		10 sek. - 15 min.		10 sek. - 7 min.
natynkowy surface mounting		natynkowy surface mounting		natynkowy surface mounting		natynkowy surface mounting
52 / 80 / 124		55,5 / 80,2 / 68,2		81,6 / 91,7 / 66,5		52 / 80 / 124
×		×		3 rodzaje montażu (3-position installation)		×

							
OR-CR-255	OR-CR-207	OR-CR-235	OR-CR-257	OR-CR-243	OR-CR-223	OR-CR-222	OR-CR-267
5902560328127	5907565612950	5901752484559	5900378650256	5901752485105	5901752483040	5901752483033	5908254812842
360°	360°	360°	360°	360°	360°	360°	360°
Ø20m	Ø6m	Ø6m	Ø6m	Ø6m	Ø3-6m	Ø12m	Ø12m
230V~, 50Hz	230V~, 50Hz	230V~, 50Hz	230V~, 50Hz	230V~, 50Hz	230V~, 50Hz	230V~, 50Hz	230V~, 50Hz
2000W / 500W	1200W / 300W	800W / 200W	300W / 75W	800W / 200W	1200W / 300W	1200W / 300W	1200W / 300W
✓	×	✓	✓	×	×	✓	✓
<3—2000 lux	<3—2000 lux	<3—2000 lux	<3—2000 lux	<3—2000 lux	<3—2000 lux	<3—2000 lux	<3—2000 lux
10 sek. - 30 min.	10 sek. - 15 min.	10 sek. - 15 min.	10 sek. - 15 min.	10 sek. - 15 min.	10 sek. - 15 min.	10 sek. - 15 min.	10 sek. - 15 min.
×	×	×	×	×	✓	×	×
102,5 / 102,5 / 58,3	Ø76 / 75,6	Ø50 / 66,5	Ø43 x 66,5	Ø80 / 61,4	Ø85 / 56,7	Ø76 / 87,3	Ø76 / 87,3
×	Ø60	Ø40	Ø33	Ø60	Ø63	Ø61,5	Ø61,7
3 sensory (3 sensors)	×	MINI	MINI	×	×	3 sensory (3 sensors)	3 sensory (3 sensors)
							
OR-CR-265	OR-CR-225	OR-CR-259/W	OR-CR-259/B				
5900378654797	5901752483064	5900378653370	5900378653387				
240°	360°	360°					
10m	12m	Ø20m					
230V~, 50Hz	230V~, 50Hz	230V~, 50Hz					
1200W / 300W	1200W / 300W	2000W / 500W					
IP65	IP44	IP65					
<3—2000lux	<3—2000lux	<3—2000lux					
10 sek. - 15 min.	10 sek. - 7 min.	10 sek. - 30 min.					
natynkowy surface mounting	natynkowy surface mounting	natynkowy surface mounting					
72,7 x 125,2 x 71,4	60 / 79 / 119	172,5 / 56 / 86,5					
3 rodzaje montażu (3-position installation), 2 sensory (2 sensors)	3 rodzaje montażu (3-position installation)	czujnik obecności (presence sensor)					

				
Do puszki Flush mounting				
Model Product no	OR-CR-206	OR-CR-205	OR-CR-261	OR-CR-220
EAN	5908235905235	5901752480568	5900378654742	5901752483026
Kąt detekcji Detection angle	160°	160°	160°	160°
Zasięg detekcji Motion detection RANGE	4-9m	9m	9m	9m
Napięcie zasilania Power supply	230V~, 50Hz	230V~, 50Hz	230V~, 50Hz	230V~, 50Hz
Ilość przewodów Number of wires	2	3	2	2 / 3
Maks. obciążenie / obciążenie LED Max. load / LED load	40-500W / –	1200W / 300W	300W / 75W	500W / 125W
LUX Zakres regulacji Adjustment range	<3–2000lux	<3–2000lux	<3–2000lux	<3–2000lux
TIME Zakres regulacji Adjustment range	10 sek. - 7 min.	10 sek. - 7 min.	10 sek. - 7 min.	10 sek. - 7 min.
Montaż Installation	podtynkowy flush mounting	podtynkowy flush mounting	podtynkowy flush mounting	podtynkowy flush mounting
Wymiary (szer./wys./gl. [mm]) Dimensions (W / H / D [mm])	75 / 75 / 50	75 / 75 / 50	86 / 86 / 26	80,7 / 80,7 / 65
Wymiary otworu montażowego ([mm]) Dimensions of the mounting hole ([mm])	Ø60	Ø60	Ø60	Ø60
Inne cechy Other features	Czujnik dźwięku Built-in voice sensor	Obsługa oświetlenia LED Works with LED lighting	Obsługa oświetlenia LED Works with LED lighting	Obsługa oświetlenia LED Works with LED lighting





Mikrofalowe czujniki ruchu

MICROWAVE MOTION SENSORS

			
Model Product no	OR-CR-208	OR-CR-216	OR-CR-214
EAN	5907565612332	5901752482067	5901752483019
Kąt detekcji Detection angle	360°	360°/180°	360°/180°
Zasięg detekcji Motion detection RANGE	1-8m	1-8m	1-8m
Napięcie zasilania Power supply	230V~, 50Hz	230V~, 50Hz	230V~, 50Hz
Maks. obciążenie / obciążenie LED Max. load / LED load	1200W / 300W	1200W / 300W	1200W / 300W
LUX Zakres regulacji Adjustment range	<3–2000lux	<3–2000lux	<3–2000lux
TIME Zakres regulacji Adjustment range	10 sek. - 12 min.	10 sek. - 12 min.	10 sek. - 12 min.
Montaż Installation	natynkowy surface mounting	natynkowy surface mounting	natynkowy / podtynkowy surface / flush mounting
Wymiary (szer./wys./gl. [mm]) Dimensions (W / H / D [mm])	77,7 / 46,5 / 44	54,6 / 37,2 / 39,4	54,5 / 25 / 39,4
Wymiary otworu montażowego ([mm]) Dimensions of the mounting hole ([mm])	-	-	-
Inne cechy Other features	-	MINI	MINI

Czujniki zmierzchu





TWILIGHT SENSORS

				
Model Product no	OR-CR-227	OR-CR-209	OR-CR-233	OR-CR-232
EAN	5901752483088	5907565612943	5901752483996	5901752483989
Napięcie zasilania Power supply	230V~, 50Hz	230V~, 50Hz	230V~, 50Hz	230V~, 50Hz
Maks. obciążenie / obciążenie LED Max. load / LED load	2000W / 500W	1200W / 300W	2300W / 575W	2300W / 575W
Stopień ochrony Protection rating	IP20 / IP54	IP44	IP20 / IP65	IP20 / IP65
LUX Zakres regulacji Adjustment range	<5–50lux	2–300lux	<2–100lux	<2–100lux
TIME Zakres regulacji Adjustment range	-	1 do 8h lub od zmierzchu do świtu 1 to 8h or from dusk to dawn	-	-
Montaż Installation	natynkowy surface mounting	natynkowy surface mounting	natynkowy surface mounting	natynkowy surface mounting
Wymiary (szer./wys./gt. [mm]) Dimensions (W / H / D [mm])	56,8 / 37,3 / 24	70 / 108 / 40	48 / 63,4 / 29,3	48 / 63,4 / 29,3
Wymiary sondy (szer./wys./gt. [mm]) Dimensions of the probe (W/H/D [mm])	Ø12	-	Ø9,6	42 / 48 / 30

				
OR-CR-229	OR-CR-212	OR-CR-240	OR-CR-218	OR-CR-239
5901752483408	5901752481633	5901752485075	5901752482074	5901752485068
360°/180°	360°	360°	360°	180°
2-8m / 1,5-3,5m	1-8m	1-8m	1-8m	5-15m
230V~, 50Hz	230V~, 50Hz	230V~, 50Hz	230V~, 50Hz	230V~, 50Hz
1200W / 300W	1200W / 300W	2000W / 500W	1200W / 300W	1200W / 300W
5lux, 30lux, 150lux, 2000lux	<3–2000lux	<3–2000lux	<3–2000lux	<3–2000lux
5 sek. - 5 min.	10 sek. - 12 min.	10 sek. - 12 min.	10 sek. - 12 min.	10 sek. - 12 min.
natynkowy / podtynkowy surface / flush mounting	natynkowy surface mounting	natynkowy surface mounting	podtynkowy flush mounting	podtynkowy flush mounting
56,8 / 25 / 39,4	Ø102,5 / 43,5	Ø115 / 24,3	Ø76 / 75,4	80 / 80 / 32
-	-	-	Ø61,5	Ø60
MINI, przełączniki DIP (DIP-switch)	-	ultra płaski (ultra flat)	-	-

Pozostałe czujniki

OTHER SENSORS

				
Model Product nox	OR-CR-211	OR-CR-211/12-24V	OR-CR-213	OR-CR-244
EAN	5901752481534	5902560327540	5901752482548	5901752485266
Typ czujnika Type of sensor	podczerwień infrared	podczerwień infrared	zbliżeniowy proximity	zbliżeniowy proximity
Kąt detekcji Detection angle	360°	360°	-	-
Zasięg detekcji Motion detection RANGE	Ø3m / Ø6m	Ø3m / Ø6m	5cm	5cm
Napięcie zasilania Power supply	230V~, 50Hz	12/24VDC	230V~, 50Hz	230V~, 50Hz
Maks. obciążenie / obciążenie LED Max. load / LED load	800W / 200W	60-120W / 60-120W	500W / 125W	250W / 62W
Stopień ochrony Protection rating	IP20	IP20	IP20	IP20
LUX Zakres regulacji Adjustment range	< 10 - 2000 lux	< 10 - 2000 lux	-	-
TIME Zakres regulacji Adjustment range	5 sek., 30 sek., 1 min., 3 min., 5 min., 8 min.	5 sek., 30 sek., 1 min., 3 min., 5 min., 8 min.	-	-
Montaż Installation	natynkowy surface mounting	natynkowy surface mounting	natynkowy surface mounting	natynkowy surface mounting
Wymiary otworu montażowego (mm) Dimensions of the mounting hole (mm)	Ø12	Ø12	Ø13	Ø13
Wymiary (szer./wys./gt. [mm]) Dimensions (W / H / D [mm])	26,4 / 34 / 55,8	26,4 / 34 / 55,8	78 / 35 / 19	90 / 40 / 18
Inne cechy Other features	przełączniki DIP (DIP-switch)	przełączniki DIP (DIP-switch)	2-biegunowy (two-way sensor)	1-biegunowy (one-way sensor)



		
OR-CR-245	OR-CR-260	OR-CR-246
5901752485273	5900378653394	5901752486607
indukcyjny inductive	podczerwień infrared	mikrofalowy microwave
-	120°	360°
-	10m	1-8m
230V~, 50Hz	12/24VDC	230V~, 50Hz
500W / 125W	60W LED	1200W / 300W
IP20	IP20	IP20
-	-	<3—2000lux
-	30 sek./120 sek./360 sek.	min: 10 sek.; max: 12 min.
natynkowy surface mounting	natynkowy surface mounting	natynkowy surface mounting
-	-	Ø7
90 / 40 / 18	50 / 37 / 31	28 / 96,2 / 51
-	regulacja stopnia przyciemnienia w zakresie 10%-100% (adjustment of dimming with 10%-100% range)	-

Zestaw bezprzewodowych gniazd sterowanych pilotem

Set of wireless sockets with remote control



Główne cechy / Main features

Maks. obciążenie: 1000W
Max. load: 1000W



Kompatybilne z Orno Smart Home
Compatible with Orno Smart Home



Wymiary (szer./wys./gt. [mm]):
Odbiornik: 52 / 111 / 65, Nadajnik: 43 / 114 / 12
Dimensions (W/H/D [mm]):
Receiver: 52 / 111 / 65, Transmitter: 43 / 114 / 12



Symbol Product no.	EAN	Zasilanie Power supply	Zasięg Range	Ilość gniazd Number of sockets	Typ gniazda Type of socket	Standard gniazda Standard of the socket	Stopień ochrony Protection rating	Napięcie zasilania nadajnika Power supply of the transmitter
OR-GB-420	5902560320145	230V~, 50Hz	25m	1	2P+Z 2P+E	french (typ E) french (E type)	IP20	1 x CR2032
OR-GB-420(GS)	5902560324723	230V~, 50Hz	25m	1	2P+Z 2P+E	Schuko (typ F) Schuko (F type)	IP20	1 x CR2032
OR-GB-418	5902560320138	230V~, 50Hz	25m	2	2P+Z 2P+E	french (typ E) french (E type)	IP20	1 x CR2032
OR-GB-418(GS)	5902560324716	230V~, 50Hz	25m	2	2P+Z 2P+E	Schuko (typ F) Schuko (F type)	IP20	1 x CR2032
OR-GB-417	5902560320121	230V~, 50Hz	25m	3	2P+Z 2P+E	french (typ E) french (E type)	IP20	1 x CR2032
OR-GB-417(GS)	5902560324709	230V~, 50Hz	25m	3	2P+Z 2P+E	Schuko (typ F) Schuko (F type)	IP20	1 x CR2032

Zestaw bezprzewodowych gniazd MINI sterowanych pilotem

Set of MINI wireless sockets with remote control



Główne cechy / Main features

Maks. obciążenie: 3000W
Max. load: 3000W



Kompatybilne z Orno Smart Home
Compatible with Orno Smart Home



Wymiary (szer./wys./gt. [mm]):
Odbiornik: 55 / 55 / 80, Nadajnik: 80,5 / 38 / 13
Dimensions (W/H/D [mm]):
Receiver: 55 / 55 / 80, Transmitter: 80,5 / 38 / 13



Symbol Product no.	EAN	Zasilanie Power supply	Zasięg Range	Ilość gniazd Number of sockets	Typ gniazda Type of socket	Standard gniazda Standard of the socket	Stopień ochrony Protection rating	Napięcie zasilania nadajnika Power supply of the transmitter
OR-GB-440	5900378653790	230V~, 50Hz	30m	1	2P+Z 2P+E	french (typ E) french (E type)	IP20	1 x CR2032
OR-GB-440(GS)	5908254811845	230V~, 50Hz	30m	1	2P+Z 2P+E	Schuko (typ F) Schuko (F type)	IP20	1 x CR2032
OR-GB-439	5900378653776	230V~, 50Hz	30m	2	2P+Z 2P+E	french (typ E) french (E type)	IP20	1 x CR2032
OR-GB-439(GS)	5908254811852	230V~, 50Hz	30m	2	2P+Z 2P+E	Schuko (typ F) Schuko (F type)	IP20	1 x CR2032
OR-GB-438	5900378653165	230V~, 50Hz	30m	3	2P+Z 2P+E	french (typ E) french (E type)	IP20	1 x CR2032
OR-GB-438(GS)	5900378654728	230V~, 50Hz	30m	3	2P+Z 2P+E	Schuko (typ F) Schuko (F type)	IP20	1 x CR2032

Zestaw zewnętrznych, bezprzewodowych gniazd sterowanych pilotem

Set of outdoor wireless sockets with remote control

Główne cechy / Main features



Maks. obciążenie: 1000W
Max. load: 1000W



Kompatybilne z Orno Smart Home
Compatible with Orno Smart Home



Wymiary (szer./wys./gł. [mm]):
Odbiornik: 60 / 123 / 66, Nadajnik: 43 / 114 / 12
Dimensions (W/H/D [mm]):
Receiver: 60 / 123 / 66, Transmitter: 43 / 114 / 12



Symbol Product no.	EAN	Zasilanie Power supply	Zasięg Range	Ilość gniazd Number of sockets	Typ gniazda Type of socket	Standard gniazda Standard of the socket	Stopień ochrony Protection rating	Napięcie zasilania nadajnika Power supply of the transmitter
OR-GB-429	5902560323214	230V~, 50Hz	25m	2	2P+Z 2P+E	french (typ E) french (E type)	IP44	1 x CR2032
OR-GB-429(GS)	5908254811876	230V~, 50Hz	25m	2	2P+Z 2P+E	Schuko (typ F) Schuko (F type)	IP44	1 x CR2032

Zestaw zewnętrznych, bezprzewodowych gniazd MINI sterowanych pilotem

Set of MINI outdoor wireless sockets with remote control

Główne cechy / Main features



Maks. obciążenie: 3000W
Max. load: 3000W



Kompatybilne z Orno Smart Home
Compatible with Orno Smart Home



Wymiary (szer./wys./gł. [mm]):
Odbiornik: 55 / 55 / 80, Nadajnik: 80,5 / 38 / 13
Dimensions (W/H/D [mm]):
Receiver: 55 / 55 / 80, Transmitter: 80,5 / 38 / 13



Symbol Product no.	EAN	Zasilanie Power supply	Zasięg Range	Ilość gniazd Number of sockets	Typ gniazda Type of socket	Standard gniazda Standard of the socket	Stopień ochrony Protection rating	Napięcie zasilania nadajnika Power supply of the transmitter
OR-GB-441	5900378653844	230V~, 50Hz	30m	2	2P+Z 2P+E	french (typ E) french (E type)	IP44	1 x CR2032
OR-GB-441(GS)	5908254811869	230V~, 50Hz	30m	2	2P+Z 2P+E	Schuko (typ F) Schuko (F type)	IP44	1 x CR2032

Przedłużacz sterowany bezprzewodowo

Power strip with remote control



Główne cechy / Main features

Maks. obciążenie: 2300W
Max. load: 2300W



Pilot w zestawie
Remote control included



Wymiary (szer./wys./gł. [mm]): 390 / 45 / 68
Dimensions (W/H/D [mm]): 390 / 45 / 68



Symbol Product no.	EAN	Zasilanie Power supply	Ilość gniazd Number of sockets	Typ gniazda Type of socket	Standard gniazd Standard of the socket	Typ izolacji Type of insulation	Rodzaj przewodu Type of cable	Ilość przewodów Number of wires	Przekrój żyty Wire cross-section	Długość przewodu Length of the wire
OR-AE-13132	5902560328660	230V~, 50Hz	5	2P+Z 2P+E	french (typ E) french (E type)	PVC	H05VV-F	3	1,5 mm ²	3m
OR-AE-13132(GS)	5900378655701	230V~, 50Hz	5	2P+Z 2P+E	Schuko (typ F) Schuko (F type)	PVC	H05VV-F	3	1,5 mm ²	3m

Bezprzewodowy 3-kanalowy sterownik oświetlenia z pilotem

3-channel wireless light switch with remote control



Główne cechy / Main features

Wymiary (szer./wys./gł. [mm]):
Odbiornik: 115 / 50 / 25, Nadajnik: 52 / 103 / 33



Dimensions (W/H/D [mm]):
Receiver: 115 / 50 / 25, Transmitter: 52 / 103 / 33

Symbol Product no.	EAN	Zasilanie Power supply	Zasięg Range	Piloty Remote controls	Maks. obciążenie Max. load	Stopień ochrony Protection rating	Napięcie zasilania nadajnika Power supply of the transmitter
OR-GB-447	5908254816437	230V~, 50Hz	30m	1	1000W	IP20	2 x AAA
OR-GB-448	5908254817144	230V~, 50Hz	30m	2	1000W	IP20	2 x AAA

Kontroler GSM do sterowania bramą

GSM controller for gate control



Główne cechy / Main features

Wejście USB
USB input



Programowanie za pomocą PC
Infrared programming via PC



Darmowa aplikacja
Free App



Wyjście przekaźnikowe
Relay output



Symbol Product no.	EAN	Zasilanie Power supply	Maks. obciążenie Max. load	Kolor Color	Stopień ochrony Protection rating	Wymiary (szer./wys./gł. [mm]) Dimensions (W/H/D [mm])
OR-GB-449	5908254817267	12V DC	2300W	biały white	IP20	76 / 140 / 27



ORNO
smart home

Sterowanie bezprzewodowe

DOSTOSOWANE DO TWOICH POTRZEB

WIRELESS CONTROL THAT SUITS YOUR NEEDS

Sterowanie bezprzewodowe

DOSTOSOWANE DO TWOICH POTRZEB

WIRELESS CONTROL THAT SUITS YOUR NEEDS

NADAJNIKI TRANSMITTERS

OR-SH-1750



Włącznik pojedynczy
natynkowy (pilot)
Single switch
surface mounted
(remote control)

OR-SH-1751



Włącznik podwójny
natynkowy (pilot)
Double switch
surface mounted
(remote control)

OR-SH-1752



Pilot zdalnego sterowania
Remote control
unit

OR-SH-1753



Nadajnik pojedynczy
podtynkowy
Single flush-mounted
transmitter

433MHz

Komunikacja radiowa
Radio communication



ODBIORNIKI RECEIVERS

OR-SH-1732



Gniazdo sieciowe
Wireless
power socket

OR-SH-1733



Gniazdo sieciowe
Outdoor wireless
power socket

OR-SH-1734



Przełącznik podtynkowy
(ON/OFF)
Wall-switch
suitable for
flush-mounting

OR-SH-1735



Przełącznik podtynkowy
(roletowy)
Roller-shutter
suitable for
flush-mounting

OR-SH-1736



Przełącznik podtynkowy
mini (ON/OFF)
MINI wall switch
suitable for
flush-mounting

Łącz dowolną ilość nadajników i odbiorników.
Combine any number of transmitters and receivers.

Dodatkowe możliwości Additional possibilities

OR-SH-1731



Gniazdo centralne wi-fi

Steruj urządzeniami z dowolnego miejsca za pomocą smartfona.

Wi-Fi hub - central socket

Manage devices with your smartphone from wherever you are.



Powered by

tuya

Intelligence
Inside

ORNO

smart home



Gniazdo centralne z komunikacją Wi-Fi i nadajnikiem radiowym

Wi-Fi hub - central socket
with radio transmitter



Powered by
tuya[®]
Intelligence
Inside

Gniazdo centralne
Central socket



Główne cechy / Main features

Komunikacja Wi-Fi
Wi-Fi hub



Nadajnik radiowy
Radio transmitter

**433
MHz**

Maks. obciążenie: 3000W
Max. load: 3000W



Możliwość rozbudowy
Possibility of extension



Wymiary (szer./wys./gł. [mm]): 55 / 55 / 80
Dimensions (W/H/D [mm]): 55 / 55 / 80



Symbol Product no.	EAN	Zasilanie Power supply	Zasięg Range	Typ gniazda Type of socket	Standard gniazda Standard of the socket	Stopień ochrony Protection rating
OR-SH-1731	5908254810589	230V~, 50Hz	30m	2P+Z 2P+E	french (typ E) french (E type)	IP20

NADAJNIKI / TRANSMITTERS

ORNO
smart home



Symbol Product no	OR-SH-1731	OR-SH-1752
EAN	5908254810589	5908254810671
Zasilanie Power supply	230V~, 50Hz	1 x CR2032
Zasięg Range	30m	30m
Liczba kanałów Number of channels	50	4
Maks. obciążenie / obciążenie LED Max. load / LED load	3000W / 750W	-
Typ gniazda Type of socket	2P+Z 2P+E	-
Standard gniazda Standard of the socket	french (typ E) french (E type)	-
Wymiary (szer./wys./gt. [mm]) Dimensions (w / h / d [mm])	55 / 55 / 80	92 / 39 / 13
Inne cechy Other features	Komunikacja Wi-Fi, nadajnik radiowy 433MHz, możliwość rozbudowy (Wi-Fi hub, radio transmitter 433MHz, possibility of extension)	Możliwość rozbudowy (Possibility of extension)



ODBIORNIKI / RECEIVERS

ORNO
smart home



Symbol Product no	OR-SH-1732	OR-SH-1733
EAN	5908254810596	5908254810602
Zasilanie Power supply	230V~, 50Hz	230V~, 50Hz
Zasięg Range	30m	30m
Maks. obciążenie / obciążenie LED Max. load / LED load	3000W / 750W	3000W / 750W
Typ gniazda Type of socket	2P+Z 2P+E	2P+Z 2P+E
Standard gniazda Standard of the socket	french (typ E) french (E type)	french (typ E) french (E type)
Stopień ochrony Protection rating	IP20	IP44
Wymiary (szer./wys./gt. [mm]) Dimensions (w / h / d [mm])	55 / 55 / 80	52 / 55 / 80
Inne cechy Other features	Możliwość rozbudowy (Possibility of extension)	Możliwość rozbudowy (Possibility of extension)

		
OR-SH-1750	OR-SH-1751	OR-SH-1753
5908254810657	5908254810664	5908254810688
1 x CR2032	1 x CR2032	230V~, 50Hz
30m	30m	30m
1	2	1
-	-	-
-	-	-
-	-	-
80 / 80 / 16	80 / 80 / 16	52 / 48 / 15
Możliwość montażu na płaskiej powierzchni, możliwość rozbudowy (Can be mounted on flat surface, possibility of extension)	Możliwość montażu na płaskiej powierzchni, możliwość rozbudowy (Can be mounted on flat surface, possibility of extension)	Możliwość rozbudowy (Possibility of extension)

		
OR-SH-1734	OR-SH-1735	OR-SH-1736
5908254810619	5908254810626	5908254810633
230V~, 50Hz	230V~, 50Hz	230V~, 50Hz
30m	30m	30m
1000W / 250W	300W / -	400W / 125W
-	-	-
-	-	-
IP20	IP20	IP20
52 / 52 / 25	52 / 52 / 25	52 / 48 / 15
Możliwość rozbudowy (Possibility of extension)	Sterowanie roletami i żaluzjami, możliwość rozbudowy (Controlling roller blinds and shutters, possibility of extension)	Jednoczesne sterowanie lokalne i radiowe, możliwość rozbudowy (Simultaneous local and remote control, possibility of extension)



nowa marka oświetleniowa new lighting brand

Nowe pomysły potrzebują właściwej przestrzeni aby wykorzystać swój potencjał.

Zmiana naszego podejścia do produktów oświetleniowych w ofercie ORNO, skłoniła nas do stworzenia dedykowanej marki oświetleniowej.

New ideas need the right space to grow and develop.

We have changed our attitude towards lighting products offered by ORNO, which resulted in creation of a new dedicated lighting brand.

Adviti



home
automation

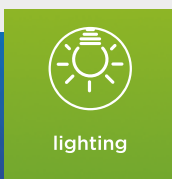

lighting



electric

Produkty oświetleniowe sygnowane marką ORNO zostaną stopniowo wycofane z oferty.

**W ich miejsce pojawiają się odświeżone
oraz nowe produkty sygnowane marką Adviti.**

ORNO branded lighting products will be gradually withdrawn from the offer.

**Former ORNO products are now being refreshed
or replaced by new ADVITI branded products.**

Adviti
LIGHTING SOLUTIONS

Udekoruj światłem **swój dom**
Adorn **your home** with light

lighting line



116

Oprawy architektoniczne

ARCHITECTURAL LIGHTING

Oświetlenie robocze

WORK LIGHTING

Highbay

HIGHBAY

Źródła światła

LIGHT SOURCES

Pozostałe oświetlenie

OTHER LIGHTING

Oprawy oświetleniowe LED LED LUMINAIRES	116
Oprawy downlight LED DOWNLIGHT.....	123
Oprawy decor DECOR LUMINAIRES.....	137
Oprawy liniowe BATTEN LIGHTS.....	141
Oprawy schodowe STAIRCASE LUMINAIRE.....	143
Naświetlacze LED LED FLOODLIGHTS.....	145
Oprawy ogrodowe GARDEN LUMINAIRES.....	150
Oświetlenie robocze WORK LIGHTING	160
Highbay HIGHBAY.....	164
Źródła światła LIGHT SOURCES	165
Pozostałe oświetlenie OTHER LIGHTING.....	168

OPRAWY OŚWIETLENIOWE LED

LED LUMINAIRES

RISMO LED OVAL

Oprawa kanałowa

Bulkhead fixture



IP65

Stopień ochrony
Protection rating



Materiał klosza: PC
Lampshade material: PC

IK08

Stopień IK
IK rating



Temperatura barwowa: 4000K
Color temperature: 4000K

Symbol Product no.	EAN	Zasilanie Power supply	Źródło światła Light source	Moc Rated power	Strumień świetlny Luminous flux	Współczynnik CRI Color rendering index	Wymiary (szer./wys./gł. [mm]) Dimensions (W x H x D [mm])
AD-OP-6157WLPM4	5908254817427	230V~, 50Hz	LED SMD	7W	630lm	≥80	195 / 105 / 55
AD-OP-6158WLPM4	5908254817434	230V~, 50Hz	LED SMD	12W	1080lm	≥80	195 / 105 / 55

RISMO LED ROUND

Oprawa kanałowa

Bulkhead fixture



IP65

Stopień ochrony
Protection rating



Materiał klosza: PC
Lampshade material: PC

IK08

Stopień IK
IK rating



Temperatura barwowa: 4000K
Color temperature: 4000K

Symbol Product no.	EAN	Zasilanie Power supply	Źródło światła Light source	Moc Rated power	Strumień świetlny Luminous flux	Współczynnik CRI Color rendering index	Wymiary (szer./wys./gł. [mm]) Dimensions (W x H x D [mm])
AD-OP-6159WLPM4	5908254817441	230V~, 50Hz	LED SMD	7W	630lm	≥80	Ø160,08 / 63
AD-OP-6160WLPM4	5908254817458	230V~, 50Hz	LED SMD	12W	1080lm	≥80	Ø160,08 / 63

LAPIS LED

Plafon oświetleniowy

Ceiling light

Stopień IK
IK rating**IK10**Stopień ochrony
Protection rating**IP65**Temperatura barwowa: 4000K
Color temperature: 4000KMateriał klosza: PC
Lampshade material: PC

Symbol Product no.	EAN	Zasilanie Power supply	Źródło światła Light source	Moc Rated power	Strumień świetlny Luminous flux	Współczynnik CRI Color rendering index	Wymiary (szer./wys./gł. [mm]) Dimensions (W x H x D [mm])
AD-PL-6118WLPM4	5908254817632	230V~, 50Hz	LED SMD	12W	800lm	≥85	Ø270 / 68,5

VEGA LED NEW

Plafon oświetleniowy

Ceiling light

Stopień ochrony
Protection rating**IP44**Temperatura barwowa: 4000K
Color temperature: 4000KMateriał: PMMA + stal
Material: PMMA + steel

Symbol Product no.	EAN	Zasilanie Power supply	Źródło światła Light source	Moc Rated power	Strumień świetlny Luminous flux	Współczynnik CRI Color rendering index	Wymiary (szer./wys./gł. [mm]) Dimensions (W x H x D [mm])
AD-PL-6128WLXM4	5908254822810	230V~, 50Hz	LED SMD	12W	840lm	≥80	Ø265 / 90
AD-PL-6129WLXM4	5908254822827	230V~, 50Hz	LED SMD	18W	1260lm	≥80	Ø300 / 90
AD-PL-6130WLXM4	5908254822834	230V~, 50Hz	LED SMD	24W	1680lm	≥80	Ø385 / 90

CERS LED

Plafon oświetleniowy

Ceiling light

Stopień IK
IK rating**IK10**Stopień ochrony
Protection rating**IP65**Temperatura barwowa: 4000K
Color temperature: 4000KMateriał klosza: PC
Lampshade material: PC

Symbol Product no.	EAN	Zasilanie Power supply	Źródło światła Light source	Moc Rated power	Strumień świetlny Luminous flux	Współczynnik CRI Color rendering index	Wymiary (szer./wys./gł. [mm]) Dimensions (W x H x D [mm])
AD-PL-6113WLPM4	5908254818684	230V~, 50Hz	LED SMD	16W	1300lm	≥85	Ø265 / 40
AD-PL-6091WLPM4	5908254822780	230V~, 50Hz	LED SMD	22W	2000lm	≥85	Ø300 / 40



PORFIR LED

Oprawa oświetleniowa z numerem domu
House lamp with number



Główne cechy / Main features

IP65

Stopień ochrony
Protection rating



Czujnik zmierzchowy
Twilight sensor



Współczynnik CRI: ≥ 85
Color rendering index: ≥ 85

IK10

Stopień IK
IK rating



Materiał klosza: PC
Lampshade material: PC



Temperatura barwowa: 4000K
Color temperature: 4000K

Symbol Product no.	EAN	Zasilanie Power supply	Źródło światła Light source	Moc Rated power	Strumień świetlny Luminous flux	Zakres regulacji (LUX) Adjustment range (LUX)	Wymiary (szer./wys./gł. [mm]) Dimensions (W x H x D [mm])
AD-OP-6117LPM4	5908254818554	230V~, 50Hz	LED SMD	12W	950lm	<3-2000lux	300 / 195 / 52



Wymienne źródło światła
Replaceable light source

MARIN

Plafon oświetleniowy z mikrofalowym czujnikiem ruchu
Ceiling light with microwave sensor



Materiał: PC + szkło
Material: PC + glass



Stopień ochrony
Protection rating

IP44

Symbol Product no.	EAN	Zasilanie Power supply	Źródło światła Light source	Czujnik ruchu Motion sensor	Kąt detekcji Detection angle	Zasięg detekcji Detection range	Zakres regulacji (LUX) Adjustment range (LUX)	Zakres regulacji (TIME) Adjustment range (TIME)	Wymiary (szer./wys./gl. [mm]) Dimensions (W x H x D [mm])
AD-PL-303WE27SMM	5908254817588	230V~, 50Hz	E27	mikrofalowy microwave	360°	Ø2m-16m	<3-2000 lux	min: 10s ± 3s; max: 12min ± 1min	Ø275 / 117

ZONDA LED

Plafon z czujnikiem ruchu PIR
Ceiling light with PIR sensor



Stopień ochrony
Protection rating

IP20

Temperatura barwowa: 4000K
Color temperature: 4000K



Materiał klosza: PC
Lampshade material: PC



Współczynnik CRI: ≥80
Color rendering index: ≥80



Symbol Product no.	EAN	Zasilanie Power supply	Moc Rated power	Strumień świetlny Luminous flux	Kąt detekcji Detection angle	Zasięg detekcji Detection range	Zakres regulacji (LUX) Adjustment range (LUX)	Zakres regulacji (TIME) Adjustment range (TIME)	Wymiary (szer./wys./gl. [mm]) Dimensions (W x H x D [mm])
AD-PL-349WLPMR4	5908254817595	230V~, 50Hz	12W	800lm	360°	Ø6m	<3-2000 lux	min: 10s ± 3s; max: 3min ± 30s	Ø290 / 67
AD-PL-6076WLPMR4	5908254817625	230V~, 50Hz	16W	1100lm	360°	Ø6m	<3-2000 lux	min: 10s ± 3s; max: 12min ± 1min	Ø290 / 67
AD-PL-391WLPMR4 	5908254817601	230V~, 50Hz	12W 1,2W	800lm 80lm	360°	Ø6m	<3-2000 lux	min: 10s ± 3s; max: 3min ± 30s	Ø290 / 67

VIRAZON LED

Plafon z czujnikiem ruchu PIR
Wall and ceiling light with PIR sensor



Stopień ochrony
Protection rating

IP44
IK10

Temperatura barwowa: 4000K
Color temperature: 4000K



Materiał klosza: PC
Lampshade material: PC



Współczynnik CRI: ≥80
Color rendering index: ≥80



Symbol Product no.	EAN	Zasilanie Power supply	Moc Rated power	Strumień świetlny Luminous flux	Kąt detekcji Detection angle	Zasięg detekcji Detection range	Zakres regulacji (LUX) Adjustment range (LUX)	Zakres regulacji (TIME) Adjustment range (TIME)	Wymiary (szer./wys./gl. [mm]) Dimensions (W x H x D [mm])
AD-PL-6064WLPMR4	5908254817618	230V~, 50Hz	15W	1050lm	160°	9m	<3-2000 lux	min: 10s ± 3s; max: 5min ± 1min	Ø250 / 49

VEGA-MV LED NEW

Plafon oświetleniowy z mikrofalowym czujnikiem ruchu

Ceiling light with microwave sensor



IP44

Stopień ochrony
Protection rating



Materiał: PMMA + stal
Material: PMMA + steel



Temperatura barwowa: 4000K
Color temperature: 4000K



Współczynnik CRI: ≥80
Color rendering index: ≥80

Symbol Product no.	EAN	Zasilanie Power supply	Moc Rated power	Strumień światłny Luminous flux	Kąt detekcji Detection angle	Zasięg detekcji Detection range	Zakres regulacji (LUX) Adjustment range (LUX)	Zakres regulacji (TIME) Adjustment range (TIME)	Wymiary (szer./wys./gł. [mm]) Dimensions (W x H x D [mm])
AD-PL-6128WLXMM4	5908254822841	230V~, 50Hz	12W	840lm	150°	4-6m	25lux / 2000lux	5s, 1min, 3min, 10min	Ø282 / 90
AD-PL-6129WLXMM4	5908254822858	230V~, 50Hz	18W	1260lm	150°	4-6m	25lux / 2000lux	5s, 1min, 3min, 10min	Ø300 / 90
AD-PL-6130WLXMM4	5908254822865	230V~, 50Hz	24W	1680lm	150°	4-6m	25lux / 2000lux	5s, 1min, 3min, 10min	Ø385 / 90

LAPIS LED

Plafon oświetleniowy z mikrofalowym czujnikiem ruchu

Ceiling light with microwave sensor



**IP65
IK10**

Stopień ochrony
Protection rating



Materiał: PC
Material: PC



Temperatura barwowa: 4000K
Color temperature: 4000K



Współczynnik CRI: ≥80
Color rendering index: ≥80

Symbol Product no.	EAN	Zasilanie Power supply	Moc Rated power	Strumień światłny Luminous flux	Kąt detekcji Detection angle	Zasięg detekcji Detection range	Zakres regulacji (LUX) Adjustment range (LUX)	Zakres regulacji (TIME) Adjustment range (TIME)	Wymiary (szer./wys./gł. [mm]) Dimensions (W x H x D [mm])
AD-PL-6118WLPMM4	5908254818844	230V~, 50Hz	12W	800lm	180°/360°	Ø5m-15m	<3-2000lux	min: 10 sek. ± 3 sek.; max: 12 min. ± 1 min.	Ø270 / 68,5

CERS LED

Plafon oświetleniowy z mikrofalowym czujnikiem ruchu

Ceiling light with microwave sensor



**IP65
IK10**

Stopień ochrony
Protection rating



Materiał: PC
Material: PC



Temperatura barwowa: 4000K
Color temperature: 4000K



Współczynnik CRI: ≥80
Color rendering index: ≥80

Symbol Product no.	EAN	Zasilanie Power supply	Moc Rated power	Strumień światłny Luminous flux	Kąt detekcji Detection angle	Zasięg detekcji Detection range	Zakres regulacji (LUX) Adjustment range (LUX)	Zakres regulacji (TIME) Adjustment range (TIME)	Wymiary (szer./wys./gł. [mm]) Dimensions (W x H x D [mm])
AD-PL-6113WLPMM4	5908254819704	230V~, 50Hz	16W	1300lm	180°/360°	Ø4m-16m	<3-2000lux	min: 10s ± 3s; max: 12min ± 1min	Ø265 / 40
AD-PL-6091WLPMM4	5908254822872	230V~, 50Hz	22W	2000lm	180°/360°	Ø4m-16m	<3-2000lux	min: 10s ± 3s; max: 12min ± 1min	Ø300 / 40



GLITT LED

Oprawa oświetleniowa
Lighting fixture



Główne cechy / Main features

Stopień ochrony
Protection rating

IP20

Temperatura barwowa: 4000K
Color temperature: 4000K



Materiał: PS + stal
Material: PS + steel



Współczynnik CRI: ≥ 80
Color rendering index: ≥ 80



Symbol Product no.	EAN	Zasilanie Power supply	Źródło światła Light source	Moc Rated power	Strumień świetlny Luminous flux	Współczynnik CRI Color rendering index	Wymiary (szer./wys./gł. [mm]) Dimensions (W x H x D [mm])
AD-PD-6152LZM4	5908254821790	230V~, 50Hz	LED SMD	40W	3800lm	≥ 80	595 / 595 / 30

Akcesoria instalacyjne dedykowane do panelu GLITT LED:

Installation accessories for GLITT LED panel:



AD-PD-6152RN

Ramka do montażu natynkowego
Mounting frame for surface installation



AD-PD-6152LS

Linki do zawieszenia
Metal ropes for ceiling installation



AD-PD-6152GK

Klipsy do karton/gipsu
Clips for mounting in plaster-cardboard plates

KATY LED

Plafon oświetleniowy
Wall and ceiling light



IP54

Stopień ochrony
Protection rating



Materiał klosza: PC
Lampshade material: PC

IK10

Stopień IK
IK rating



Temperatura barwowa: 4000K
Color temperature: 4000K

Symbol Product no.	EAN	Zasilanie Power supply	Źródło światła Light source	Moc Rated power	Strumień świetlny Luminous flux	Współczynnik CRI Color rendering index	Wymiary (szer./wys./gl. [mm]) Dimensions (W x H x D [mm])
AD-PL-6134WLP4	5908254820625	230V~, 50Hz	LED SMD	24W	2000lm	≥80	300 / 300 / 54

AGGIE LED

Panel oświetleniowy
Backlight panel



IP20

Stopień ochrony
Protection rating



Materiał: PC + stal
Material: PC + steel



Temperatura barwowa: 4000K
Color temperature: 4000K

Symbol Product no.	EAN	Zasilanie Power supply	Źródło światła Light source	Moc Rated power	Strumień świetlny Luminous flux	Współczynnik CRI Color rendering index	Wymiary (szer./wys./gl. [mm]) Dimensions (W x H x D [mm])
AD-OP-6140LPM4	5908254818868	230V~, 50Hz	LED SMD	38W	3500lm	≥80	410 / 410 / 65

OPRAWY DOWNLIGHT

LED DOWNLIGHT

BARBRA DLR

Oprawa typu downlight
Downlight



AD-OD-6142WGU10



AD-OD-6141BGU10



BARBRA DLS

Oprawa typu downlight
Downlight



AD-OD-6142WGU10



AD-OD-6142BGU10



Stopień ochrony
Protection rating

IP20

Stopień ochrony
Protection rating

IP20

Symbol Product no.	EAN	Zasilanie Power supply	Moc Rated power	Źródło światła Light source	Materiał Material	Montaż Installation	Kolor Color	szer./wys./gt. [mm] W/H/D [mm]
AD-OD-6141WGU10	5908254818196	230V~, 50Hz	max. 50W	GU10	aluminium	natynkowy surface mounted	biały white	Ø56 / 100
AD-OD-6141BGU10	5908254818189	230V~, 50Hz	max. 50W	GU10	aluminium	natynkowy surface mounted	czarny black	Ø56 / 100
AD-OD-6142WGU10	5908254818219	230V~, 50Hz	max. 50W	GU10	aluminium	natynkowy surface mounted	biały white	56 / 56 / 100
AD-OD-6142BGU10	5908254818202	230V~, 50Hz	max. 50W	GU10	aluminium	natynkowy surface mounted	czarny black	56 / 56 / 100

SUTRI RC

Ramka dekoracyjna oprawy punktowej
Decorative frame for spotlight



AD-OD-6175/W



AD-OD-6175/B



AD-OD-6175/N

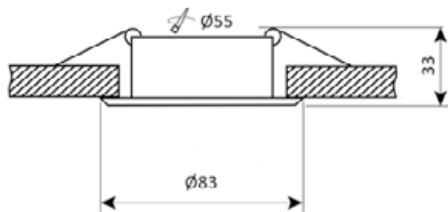

SUTRI RM

Ramka dekoracyjna oprawy punktowej
Decorative frame for spotlight



AD-OD-6176/W



AD-OD-6176/B



AD-OD-6176/N

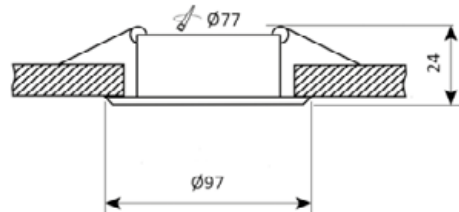

IP20

Stopień ochrony
Protection rating

IP20

Stopień ochrony
Protection rating



Regulacja kąta
Angle adjustment

Symbol Product no.	EAN	Zasilanie Power supply	Moc Rated power	Źródło światła Light source	Materiał Material	Montaż Installation	Kolor Color	Otwór montażowy Mounting hole	szer./wys./gł. [mm] W/H/D [mm]
AD-OD-6175/W	5908254818011	230V~, 50Hz / 12V	max. 50W	GU10 / MR16	stal steel	podtynkowy flush mounted	biały white	Ø55mm	Ø83/33
AD-OD-6175/B	5908254817991	230V~, 50Hz / 12V	max. 50W	GU10 / MR16	stal steel	podtynkowy flush mounted	czarny black	Ø55mm	Ø83/33
AD-OD-6175/N	5908254818004	230V~, 50Hz / 12V	max. 50W	GU10 / MR16	stal steel	podtynkowy flush mounted	satyna satin	Ø55mm	Ø83/33
AD-OD-6176/W	5908254818042	230V~, 50Hz / 12V	max. 50W	GU10 / MR16	stal steel	podtynkowy flush mounted	biały white	Ø77mm	Ø97/24
AD-OD-6176/B	5908254818028	230V~, 50Hz / 12V	max. 50W	GU10 / MR16	stal steel	podtynkowy flush mounted	czarny black	Ø77mm	Ø97/24
AD-OD-6176/N	5908254818035	230V~, 50Hz / 12V	max. 50W	GU10 / MR16	stal steel	podtynkowy flush mounted	satyna satin	Ø77mm	Ø97/24

SUTRI SC

Ramka dekoracyjna oprawy punktowej
Decorative frame for spotlight



AD-OD-6177/W

AD-OD-6177/B

AD-OD-6177/N

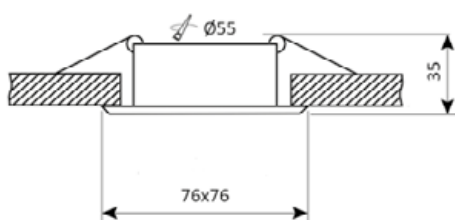

Stopień ochrony
Protection rating

IP20

SUTRI SM

Ramka dekoracyjna oprawy punktowej
Decorative frame for spotlight



AD-OD-6178/W

AD-OD-6178/B

AD-OD-6178/N

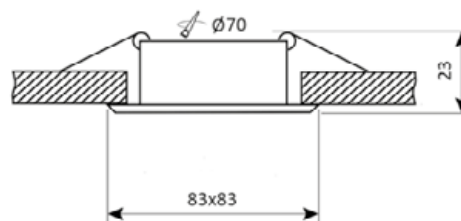

Stopień ochrony
Protection rating

IP20

Regulacja kąta
Angle adjustment



Symbol Product no.	EAN	Zasilanie Power supply	Moc Rated power	Źródło światła Light source	Materiał Material	Montaż Installation	Kolor Color	Otwór montażowy Mounting hole	szer./wys./gł. [mm] W/H/D [mm]
AD-OD-6177/W	5908254822889	230V~, 50Hz / 12V	max. 50W	GU10 / MR16	stal steel	podtynkowy flush mounted	biały white	Ø55mm	76/76/35
AD-OD-6177/B	5908254821844	230V~, 50Hz / 12V	max. 50W	GU10 / MR16	stal steel	podtynkowy flush mounted	czarny black	Ø55mm	76/76/35
AD-OD-6177/N	5908254821837	230V~, 50Hz / 12V	max. 50W	GU10 / MR16	stal steel	podtynkowy flush mounted	satyna satin	Ø55mm	76/76/35
AD-OD-6178/W	5908254818073	230V~, 50Hz / 12V	max. 50W	GU10 / MR16	stal steel	podtynkowy flush mounted	biały white	Ø70mm	83/83/23
AD-OD-6178/B	5908254818059	230V~, 50Hz / 12V	max. 50W	GU10 / MR16	stal steel	podtynkowy flush mounted	czarny black	Ø70mm	83/83/23
AD-OD-6178/N	5908254818066	230V~, 50Hz / 12V	max. 50W	GU10 / MR16	stal steel	podtynkowy flush mounted	satyna satin	Ø70mm	83/83/23

DARI R

Ramka dekoracyjna oprawy punktowej
Decorative frame for spotlight

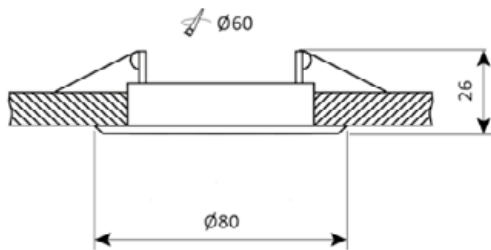

DARI S

Ramka dekoracyjna oprawy punktowej
Decorative frame for spotlight

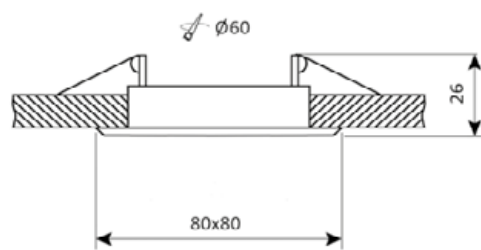

IP44

Stopień ochrony
Protection rating

IP44

Stopień ochrony
Protection rating

Symbol Product no.	EAN	Zasilanie Power supply	Moc Rated power	Źródło światła Light source	Materiał Material	Montaż Installation	Kolor Color	Otwór montażowy Mounting hole	szer./wys./gt. [mm] W/H/D [mm]
AD-OD-6170/W	5908254821752	230V~, 50Hz / 12V	max. 50W	GU10 / MR16	aluminium	podtynkowy flush mounted	biały white	Ø60mm	Ø80 / 26
AD-OD-6171/W	5908254822896	230V~, 50Hz / 12V	max. 50W	GU10 / MR16	aluminium	podtynkowy flush mounted	biały white	Ø60mm	80 / 80 / 26

HALISI RM

Ramka dekoracyjna oprawy punktowej
Decorative frame for spotlight

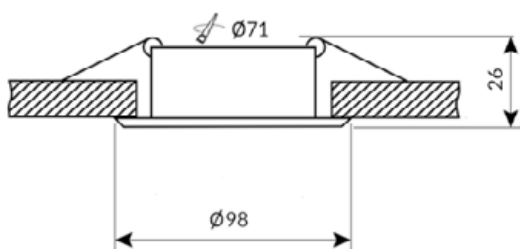

Stopień ochrony
Protection rating

IP20

Regulacja kąta
Angle adjustment



HALISI SM

Ramka dekoracyjna oprawy punktowej
Decorative frame for spotlight

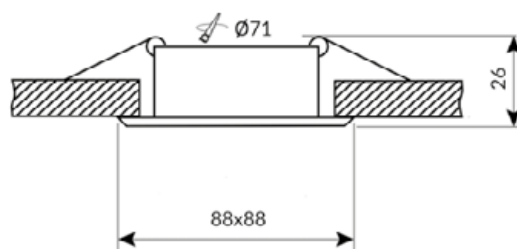

Stopień ochrony
Protection rating

IP20

Regulacja kąta
Angle adjustment



Symbol Product no.	EAN	Zasilanie Power supply	Moc Rated power	Źródło światła Light source	Materiał Material	Montaż Installation	Kolor Color	Otwór montażowy Mounting hole	szer./wys./gt. [mm] W/H/D [mm]
AD-OD-6182	5908254822902	230V~, 50Hz / 12V	max. 50W	GU10 / MR16	beton/stal concrete/steel	podtynkowy flush mounted	szary/czarny black/grey	Ø71mm	Ø98/26
AD-OD-6183	5908254822919	230V~, 50Hz / 12V	max. 50W	GU10 / MR16	beton/stal concrete/steel	podtynkowy flush mounted	szary/czarny black/grey	Ø71mm	88/88/26

SORMUS S

Ramka dekoracyjna oprawy punktowej
Decorative frame for spotlight



AD-OD-6168/W

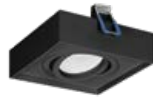

AD-OD-6168/B

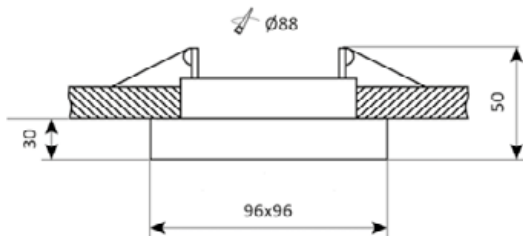

SORMUS R

Ramka dekoracyjna oprawy punktowej
Decorative frame for spotlight



AD-OD-6169/W



AD-OD-6169/B

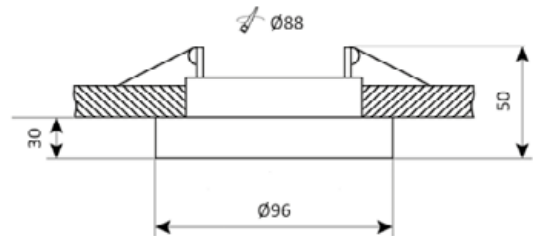

IP20

Stopień ochrony
Protection rating



Regulacja kąta
Angle adjustment

IP20

Stopień ochrony
Protection rating



Regulacja kąta
Angle adjustment

Symbol Product no.	EAN	Zasilanie Power supply	Moc Rated power	Źródło światła Light source	Materiał Material	Montaż Installation	Kolor Color	Otwór montażowy Mounting hole	szer./wys./gl. [mm] W/H/D [mm]
AD-OD-6168/W	5908254822926	230V~, 50Hz / 12V	max. 50W	GU10 / MR16	aluminium	podtynkowy flush mounted	biały white	Ø88mm	96 / 96 / 50
AD-OD-6168/B	5908254821776	230V~, 50Hz / 12V	max. 50W	GU10 / MR16	aluminium	podtynkowy flush mounted	czarny black	Ø88mm	96 / 96 / 50
AD-OD-6169/W	5908254821745	230V~, 50Hz / 12V	max. 50W	GU10 / MR16	aluminium	podtynkowy flush mounted	biały white	Ø88mm	Ø96 / 50
AD-OD-6169/B	5908254821769	230V~, 50Hz / 12V	max. 50W	GU10 / MR16	aluminium	podtynkowy flush mounted	czarny black	Ø88mm	Ø96 / 50

KORIN 10

Oprawa typu downlight
Downlight



KORIN 13

Oprawa typu downlight
Downlight



KORIN 16

Oprawa typu downlight
Downlight



AD-OD-6179WE27

AD-OD-6179BE27

AD-OD-6180WE27

AD-OD-6180BE27

AD-OD-6181WE27

AD-OD-6181BE27

Stopień ochrony
Protection rating









IP20

Stopień ochrony
Protection rating

IP20

Stopień ochrony
Protection rating

IP20

 Symbol Product no.	 EAN	 Zasilanie Power supply	 Moc Rated power	 Źródło światła Light source	 Materiał Material	 Montaż Installation	 Kolor Color	 szer./wys./gl. [mm] W/H/D [mm]
AD-OD-6179WE27	5908254818882	230V~, 50Hz	max. 60W	E27	stal steel	natynkowy surface mounted	biały white	102/123
AD-OD-6179BE27	5908254818875	230V~, 50Hz	max. 60W	E27	stal steel	natynkowy surface mounted	czarny black	102/123
AD-OD-6180WE27	5908254818905	230V~, 50Hz	max. 60W	E27	stal steel	natynkowy surface mounted	biały white	135/155
AD-OD-6180BE27	5908254818899	230V~, 50Hz	max. 60W	E27	stal steel	natynkowy surface mounted	czarny black	135/155
AD-OD-6181WE27	5908254818929	230V~, 50Hz	max. 60W	E27	stal steel	natynkowy surface mounted	biały white	165/180
AD-OD-6181BE27	5908254818912	230V~, 50Hz	max. 60W	E27	stal steel	natynkowy surface mounted	czarny black	165/180

CAROLIN DLS

Oprawa typu downlight
Downlight



AD-OD-6145WGU10

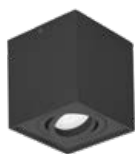

AD-OD-6145BGU10

CAROLIN DLR

Oprawa typu downlight
Downlight



AD-OD-6146WGU10



AD-OD-6146BGU10

IP20

Stopień ochrony
Protection rating

IP20

Stopień ochrony
Protection rating



Regulacja kąta
Angle adjustment

Symbol Product no.	EAN	Zasilanie Power supply	Moc Rated power	Źródło światła Light source	Materiał Material	Montaż Installation	Kolor Color	szer./wys./gł. [mm] W/H/D [mm]
AD-OD-6145WGU10	5908254818264	230V~, 50Hz	max. 35W	GU10	aluminium	natynkowy surface mounted	biały white	96 / 96 / 105
AD-OD-6145BGU10	5908254818257	230V~, 50Hz	max. 35W	GU10	aluminium	natynkowy surface mounted	czarny black	96 / 96 / 105
AD-OD-6146WGU10	5908254818271	230V~, 50Hz	max. 35W	GU10	aluminium	natynkowy surface mounted	biały white	Ø96 / 105
AD-OD-6146BGU10	5908254821820	230V~, 50Hz	max. 35W	GU10	aluminium	natynkowy surface mounted	czarny black	Ø96 / 105

MEGY DLS

Oprawa typu downlight
Downlight



AD-OD-6143WGU10



AD-OD-6143BGU10

MEGY DLR

Oprawa typu downlight
Downlight



AD-OD-6144WGU10











AD-OD-6144BGU10

Stopień ochrony
Protection rating

IP54

Stopień ochrony
Protection rating

IP54

 Symbol Product no.	 EAN	 Zasilanie Power supply	 Moc Rated power	 Źródło światła Light source	 Materiał Material	 Montaż Installation	 Kolor Color	 szer./wys./gt. [mm] W/H/D [mm]
AD-OD-6143WGU10	5908254818233	230V~, 50Hz	max. 50W	GU10	aluminium	natynkowy surface mounted	biały white	90 / 90 / 95
AD-OD-6143BGU10	5908254818226	230V~, 50Hz	max. 50W	GU10	aluminium	natynkowy surface mounted	czarny black	90 / 90 / 95
AD-OD-6144WGU10	5908254819858	230V~, 50Hz	max. 50W	GU10	aluminium	natynkowy surface mounted	biały white	Ø90 / 95mm
AD-OD-6144BGU10	5908254818240	230V~, 50Hz	max. 50W	GU10	aluminium	natynkowy surface mounted	czarny black	Ø90 / 95mm

CITY LED

Oprawa typu downlight
Downlight



AD-OD-6057WLX3
AD-OD-6057WLX4



AD-OD-6058WLX3
AD-OD-6058WLX4



AD-OD-6059WLX3
AD-OD-6059WLX4
AD-OD-6074WLX3
AD-OD-6074WLX4



Wbudowany zasilacz
Built-in power supply

IP20

Stopień ochrony
Protection rating

Symbol Product no.	EAN	Zasilanie Power supply	Moc Rated power	Źródło światła Light source	Materiał klosza Lampshade material	Montaż Installation	Kolor Color	Temperatura barwowa Color temperature	Strumień świetlny Luminous flux	szer./wys./gł. [mm] W/H/D [mm]
AD-OD-6057WLX3	5908254818318	230V~, 50Hz	12W	LED SMD	PMMA	natynkowy surface mounted	biały white	3000K	800lm	Ø176,5 / 34,5
AD-OD-6057WLX4	5908254818783	230V~, 50Hz	12W	LED SMD	PMMA	natynkowy surface mounted	biały white	4000K	860lm	Ø176,5 / 34,5
AD-OD-6058WLX3	5908254818325	230V~, 50Hz	18W	LED SMD	PMMA	natynkowy surface mounted	biały white	3000K	1500lm	Ø226 / 34,5
AD-OD-6058WLX4	5908254821349	230V~, 50Hz	18W	LED SMD	PMMA	natynkowy surface mounted	biały white	4000K	1600lm	Ø226 / 34,5
AD-OD-6059WLX3	5908254818790	230V~, 50Hz	20W	LED SMD	PMMA	natynkowy surface mounted	biały white	3000K	1600lm	Ø246,5 / 34,5
AD-OD-6059WLX4	5908254822933	230V~, 50Hz	20W	LED SMD	PMMA	natynkowy surface mounted	biały white	4000K	1700lm	Ø246,5 / 34,5
AD-OD-6074WLX3	5908254818813	230V~, 50Hz	24W	LED SMD	PMMA	natynkowy surface mounted	biały white	3000K	1900lm	Ø246,5 / 34,5
AD-OD-6074WLX4	5908254818820	230V~, 50Hz	24W	LED SMD	PMMA	natynkowy surface mounted	biały white	4000K	2000lm	Ø246,5 / 34,5

LETI LED

Oprawa typu downlight
Downlight



AD-OD-6060WLED3
AD-OD-6060WLED4



AD-OD-6061WLED3
AD-OD-6061WLED4



AD-OD-6062WLED3
AD-OD-6062WLED4
AD-OD-6075WLED3
AD-OD-6075WLED4

Wbudowany zasilacz
Built-in power supply



Stopień ochrony
Protection rating



Symbol Product no.	EAN	Zasilanie Power supply	Moc Rated power	Źródło światła Light source	Materiał klosza Lampshade material	Montaż Installation	Kolor Color	Temperatura barwowa Color temperature	Strumień świetlny Luminous flux	szer./wys./gł. [mm] W/H/D [mm]
AD-OD-6060WLED3	5908254818332	230V~, 50Hz	9W	LED SMD	PMMA	natynkowy surface mounted	biały white	3000K	530lm	122 / 122 / 34,5
AD-OD-6060WLED4	5908254822940	230V~, 50Hz	9W	LED SMD	PMMA	natynkowy surface mounted	biały white	4000K	540lm	122 / 122 / 34,5
AD-OD-6061WLED3	5908254822957	230V~, 50Hz	12W	LED SMD	PMMA	natynkowy surface mounted	biały white	3000K	800lm	172 / 172 / 34,5
AD-OD-6061WLED4	5908254822964	230V~, 50Hz	12W	LED SMD	PMMA	natynkowy surface mounted	biały white	4000K	860lm	172 / 172 / 34,5
AD-OD-6062WLED3	5908254818349	230V~, 50Hz	18W	LED SMD	PMMA	natynkowy surface mounted	biały white	3000K	1500lm	227 / 227 / 34,5
AD-OD-6062WLED4	5908254818806	230V~, 50Hz	18W	LED SMD	PMMA	natynkowy surface mounted	biały white	4000K	1600lm	227 / 227 / 34,5
AD-OD-6075WLED3	5908254818356	230V~, 50Hz	24W	LED SMD	PMMA	natynkowy surface mounted	biały white	3000K	1900lm	227 / 227 / 34,5
AD-OD-6075WLED4	5908254818837	230V~, 50Hz	24W	LED SMD	PMMA	natynkowy surface mounted	biały white	4000K	2000lm	227 / 227 / 34,5

EURUS LED

Oprawa typu downlight
Downlight



AD-OD-6050WLX3
AD-OD-6050WLX4



AD-OD-6051WLX3
AD-OD-6051WLX4



AD-OD-6052WLX3
AD-OD-6052WLX4



AD-OD-6053WLX3
AD-OD-6053WLX4



Wbudowany zasilacz
Built-in power supply

IP20

Stopień ochrony
Protection rating

Symbol Product no.	EAN	Zasilanie Power supply	Moc Rated power	Źródło światła Light source	Materiał klosza Lampshade material	Montaż Installation	Kolor Color	Temperatura barwowa Color temperature	Strumień światłny Luminous flux	szer./wys./gl. [mm] W/H/D [mm]
AD-OD-6050WLX3	5908254822971	230V~, 50Hz	9W	LED SMD	PMMA	podtynkowy flush mounted	biały white	3000K	530lm	Ø115 / 32
AD-OD-6050WLX4	5908254821851	230V~, 50Hz	9W	LED SMD	PMMA	podtynkowy flush mounted	biały white	4000K	540lm	Ø115 / 32
AD-OD-6051WLX3	5908254822988	230V~, 50Hz	12W	LED SMD	PMMA	podtynkowy flush mounted	biały white	3000K	800lm	Ø170 / 32
AD-OD-6051WLX4	5908254822797	230V~, 50Hz	12W	LED SMD	PMMA	podtynkowy flush mounted	biały white	4000K	860lm	Ø170 / 32
AD-OD-6052WLX3	5908254823206	230V~, 50Hz	18W	LED SMD	PMMA	podtynkowy flush mounted	biały white	3000K	1500lm	Ø220 / 32
AD-OD-6052WLX4	5908254818769	230V~, 50Hz	18W	LED SMD	PMMA	podtynkowy flush mounted	biały white	4000K	1600lm	Ø220 / 32
AD-OD-6053WLX3	5908254822995	230V~, 50Hz	20W	LED SMD	PMMA	podtynkowy flush mounted	biały white	3000K	1600lm	Ø240 / 32
AD-OD-6053WLX4	5908254822803	230V~, 50Hz	20W	LED SMD	PMMA	podtynkowy flush mounted	biały white	4000K	1700lm	Ø240 / 32

AKMAN LED

Oprawa typu downlight
Downlight



AD-OD-6054WLX3
AD-OD-6054WLX4



AD-OD-6055WLX3
AD-OD-6055WLX4













AD-OD-6056WLX3
AD-OD-6056WLX4

Wbudowany zasilacz
Built-in power supply



Stopień ochrony
Protection rating



 Symbol Product no.	 EAN	 Zasilanie Power supply	 Moc Rated power	 Źródło światła Light source	 Materiał klosza Lampshade material	 Montaż Installation	 Kolor Color	 Temperatura barwowa Color temperature	 Strumień świetlny Luminous flux	 szer./wys./gł. [mm] W/H/D [mm]
AD-OD-6054WLX3	5908254823008	230V~, 50Hz	9W	LED SMD	PMMA	podtynkowy flush mounted	biały white	3000K	530lm	115 / 115 / 32
AD-OD-6054WLX4	5908254823015	230V~, 50Hz	9W	LED SMD	PMMA	podtynkowy flush mounted	biały white	4000K	540lm	115 / 115 / 32
AD-OD-6055WLX3	5908254823022	230V~, 50Hz	12W	LED SMD	PMMA	podtynkowy flush mounted	biały white	3000K	800lm	170 / 170 / 32
AD-OD-6055WLX4	5908254821868	230V~, 50Hz	12W	LED SMD	PMMA	podtynkowy flush mounted	biały white	4000K	860lm	170 / 170 / 32
AD-OD-6056WLX3	5908254823039	230V~, 50Hz	18W	LED SMD	PMMA	podtynkowy flush mounted	biały white	3000K	1500lm	220 / 220 / 32
AD-OD-6056WLX4	5908254818776	230V~, 50Hz	18W	LED SMD	PMMA	podtynkowy flush mounted	biały white	4000K	1600lm	220 / 220 / 32

SIREMO LED

Oprawa typu downlight
Downlight



AD-OD-6161WL4



AD-OD-6162WL4



Wbudowany zasilacz
Built-in power supply



Stopień ochrony
Protection rating



AD-OD-6163WL4

Symbol Product no.	EAN	Zasilanie Power supply	Moc Rated power	Źródło światła Light source	Materiał klosza Lampshade material	Montaż Installation	Kolor Color	Temperatura barwowa Color temperature	Strumień świetlny Luminous flux	szer./wys./gt. [mm] W/H/D [mm]
AD-OD-6161WL4	5908254823046	230V~, 50Hz	9W	LED SMD	PMMA	natynkowy surface mounted	biały white	4000K	720lm	Ø138 / 75
AD-OD-6162WL4	5908254823053	230V~, 50Hz	18W	LED SMD	PMMA	natynkowy surface mounted	biały white	4000K	1440lm	Ø178 / 75
AD-OD-6163WL4	5908254823060	230V~, 50Hz	24W	LED SMD	PMMA	natynkowy surface mounted	biały white	4000K	1920lm	Ø230 / 100



OPRAWY DECOR

DECOR LUMINAIRES



AD-OP-6195WGU10



AD-OP-6195BGU10

DOA SP 3

Oprawa ścienna-sufitowa
Wall and ceiling light



Regulacja kąta
Angle adjustment

IP20

Stopień ochrony
Protection rating

Symbol Product no.	EAN	Zasilanie Power supply	Moc Rated power	Źródło światła Light source	Materiał Material	Montaż Installation	Kolor Color	szer./wys./gt. [mm] W/H/D [mm]
AD-OP-6195WGU10	5908254818134	230V~, 50Hz	3 x 50 W	GU10	aluminium	natynkowy surface mounted	biały white	61 / 400 / 140
AD-OP-6195BGU10	5908254818127	230V~, 50Hz	3 x 50 W	GU10	aluminium	natynkowy surface mounted	czarny black	61 / 400 / 140

DOA SP 1

Oprawa ścienna-sufitowa
Wall and ceiling light



AD-OP-6193WGU10



AD-OP-6193BGU10

DOA SP 2

Oprawa ścienna-sufitowa
Wall and ceiling light

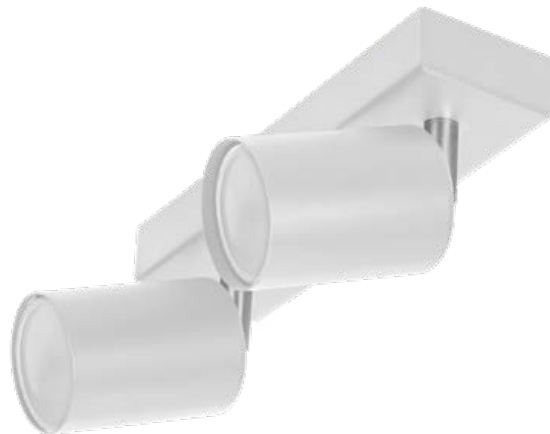

AD-OP-6194WGU10



AD-OP-6194BGU10

IP20

Stopień ochrony
Protection rating











Regulacja kąta
Angle adjustment

IP20

Stopień ochrony
Protection rating



Regulacja kąta
Angle adjustment

 Symbol Product no.	 EAN	 Zasilanie Power supply	 Moc Rated power	 Źródło światła Light source	 Materiał Material	 Montaż Installation	 Kolor Color	 szer./wys./gt. [mm] W/H/D [mm]
AD-OP-6193WGU10	5908254818097	230V~, 50Hz	50W	GU10	aluminium	natynkowy surface mounted	biały white	głowica / head Ø54 / 75 baza / base Ø80 / 140
AD-OP-6193BGU10	5908254818080	230V~, 50Hz	50W	GU10	aluminium	natynkowy surface mounted	czarny black	głowica / head Ø54 / 75 baza / base Ø80 / 140
AD-OP-6194WGU10	5908254818110	230V~, 50Hz	2 x 50W	GU10	aluminium	natynkowy surface mounted	biały white	głowica / head Ø54 / 75 baza / base 60 / 200 / 140
AD-OP-6194BGU10	5908254818103	230V~, 50Hz	2 x 50W	GU10	aluminium	natynkowy surface mounted	czarny black	głowica / head Ø54 / 75 baza / base 60 / 200 / 140



BARBRA PLR GU10

Oprawa wisząca
Pendant light

AD-OP-6189WGU10

AD-OP-6189BGU10

Stopień ochrony
Protection rating

IP20

Symbol Product no.	EAN	Zasilanie Power supply	Moc Rated power	Źródło światła Light source	Stopień ochrony Protection rating	Kolor Color	Materiał klosza Material of the lampshade	Długość przewodu Length of the wire	Wymiary (szer./wys./gt. [mm]) Dimensions (W x H x D [mm])
AD-OP-6189WGU10	5908254818295	230V~, 50Hz	max. 35W	GU10	IP20	biały white	aluminium	1000mm	Ø56 / 240
AD-OP-6189BGU10	5908254818288	230V~, 50Hz	max. 35W	GU10	IP20	czarny black	aluminium	1000mm	Ø56 / 240

Lampy nad lustro

Mirror lamps



AD-OM-6120L4
AD-OM-6120L4/B

IP44



AD-OM-6104L4
AD-OM-6104L4/B

IP44



AD-OM-6208L4
AD-OM-6208L4/B
AD-OM-6209L4
AD-OM-6209L4/B

IP44



AD-OM-6121L4
AD-OM-6121L4/B

IP44











AD-OM-6122L4
AD-OM-6122L4/B

IP44



AD-OM-6123L4
AD-OM-6123L4/B

IP44

 Symbol Product no.	 EAN	 Moc Rated power	 Źródło światła Light source	 Materiał klosza Lampshade material	 Kolor Color	 Temperatura barwowa Color temperature	 Strumień świetlny Luminous flux	 szer./wys./gł. [mm] W/H/D [mm]
AD-OM-6120L4	5908254817700	5W	LED SMD	Tworzywo sztuczne Plastic	chrom chrome	4000K	320lm	300 / 105 / 42
AD-OM-6120L4/B	5908254822186	5W	LED SMD	Tworzywo sztuczne Plastic	czarny black	4000K	320lm	300 / 105 / 42
AD-OM-6104L4	5908254817694	5W	LED SMD	Aluminium Aluminium	inox	4000K	320lm	300 / 105 / 42
AD-OM-6104L4/B	5908254822179	5W	LED SMD	Aluminium Aluminium	czarny black	4000K	320lm	300 / 105 / 42
AD-OM-6208L4	5908254822544	12W	LED SMD	Aluminium Aluminium	chrom chrome	4000K	900lm	500 / 115 / 44
AD-OM-6208L4/B	5908254822537	12W	LED SMD	Aluminium Aluminium	czarny black	4000K	900lm	500 / 115 / 44
AD-OM-6209L4	5908254822568	18W	LED SMD	Aluminium Aluminium	chrom chrome	4000K	1600lm	1000 / 115 / 44
AD-OM-6209L4/B	5908254822551	18W	LED SMD	Aluminium Aluminium	czarny black	4000K	1600lm	1000 / 115 / 44
AD-OM-6121L4	5908254819711	6W	LED SMD	Tworzywo sztuczne+akryl Plastic+acrylic	chrom chrome	4000K	540lm	400 / 105 / 42
AD-OM-6121L4/B	5908254822209	6W	LED SMD	Tworzywo sztuczne+akryl Plastic+acrylic	czarny black	4000K	540lm	400 / 105 / 42
AD-OM-6122L4	5908254818691	9W	LED SMD	Tworzywo sztuczne+akryl Plastic+acrylic	chrom chrome	4000K	810lm	600 / 105 / 42
AD-OM-6122L4/B	5908254822193	9W	LED SMD	Tworzywo sztuczne+akryl Plastic+acrylic	czarny black	4000K	810lm	600 / 105 / 42
AD-OM-6123L4	5908254817717	6W	LED SMD	Aluminium+akryl Aluminium+acrylic	chrom chrome	4000K	510lm	400 / 100 / 35
AD-OM-6123L4/B	5908254822216	6W	LED SMD	Aluminium+akryl Aluminium+acrylic	czarny black	4000K	510lm	400 / 100 / 35

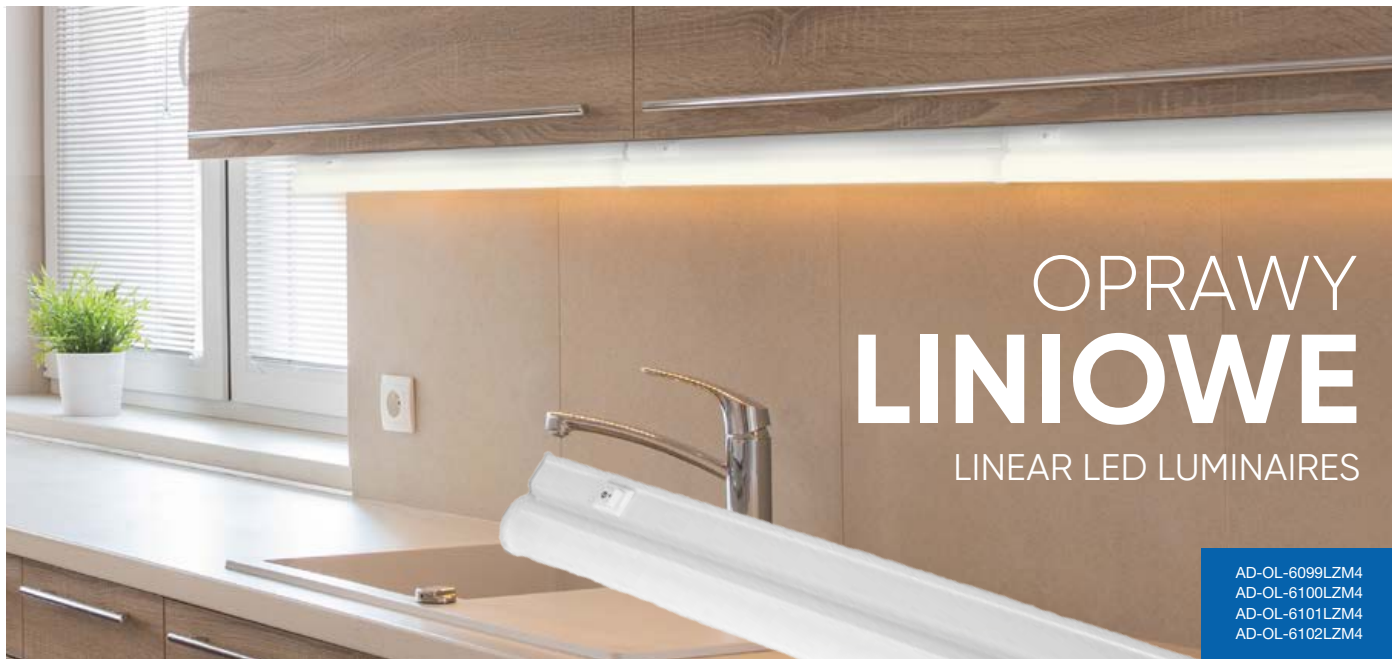

OPRAWY LINIOWE

LINEAR LED LUMINAIRES

AD-OL-6099LZM4
AD-OL-6100LZM4
AD-OL-6101LZM4
AD-OL-6102LZM4

NOTUS LED

oprawy liniowe podszafkowe

LED linear light NOTUS



AD-OL-6099CN

PRZEWÓD ŁĄCZENIOWY
Connection cable



AD-OL-6099PZ

PRZEWÓD ZASILAJĄCY
Power cord

Oprawy liniowe podszafkowe są idealnym rozwiązaniem do podświetlenia blatów i szafek kuchennych, regałów, gablot i witryn sklepowych lub biur. Można je montować we wszystkich miejscach, gdzie potrzebne jest oświetlenie liniowe. Zastosowane nowoczesne diody LED SMD gwarantują dużą energooszczędność i długą żywotność urządzenia. Każda oprawa wyposażona jest w indywidualny wyłącznik ON/OFF, gniazdo oraz wtyk 2-pinowy. Dzięki przewodowi łączeniowemu posiada możliwość łączenia w szereg – linię świetlną. Materiał: tworzywo sztuczne.

Our linear fixtures are perfect solution to provide light to tabletops and cupboards in your kitchen or your office. They can be installed in all places where linear lighting is required, such as cabinets and shop displays. The use of LED technology guarantees high energy efficiency and long service life. Each fixture is equipped with an individual ON/OFF switch, a socket and 2-pin connector plug. Thanks to the connection cable - it is possible to connect the fixtures in series – a light line. Material: plastic.



230V~, 50Hz



LED SMD



IP20



On / Off



Materiał: tworzywo sztuczne
Material: plastic

Symbol Product no.	EAN	Moc Rated power	Strumień świetlny Luminous flux	Temperatura barwowa Color temperature	Kabel zasilający Power cable	szer./wys./gl. [mm] W/H/D [mm]
AD-OL-6099LZM4	5908254817915	4W	360lm	4000K	○	310 / 26 / 37
AD-OL-6099LZM4/PZ	5908254817953	4W	360lm	4000K	● 100cm	310 / 26 / 37
AD-OL-6100LZM4	5908254817922	7W	630lm	4000K	○	560 / 26 / 37
AD-OL-6100LZM4/PZ	5908254817960	7W	630lm	4000K	● 100cm	560 / 26 / 37
AD-OL-6101LZM4	5908254817939	10W	900lm	4000K	○	864 / 26 / 37
AD-OL-6101LZM4/PZ	5908254817977	10W	900lm	4000K	● 100cm	864 / 26 / 37
AD-OL-6102LZM4	5908254817946	14W	1260lm	4000K	○	1174 / 26 / 37
AD-OL-6102LZM4/PZ	5908254817984	14W	1260lm	4000K	● 100cm	1174 / 26 / 37
AD-OL-6099PZ	5908254819223			4000K	● 100cm	
AD-OL-6099CN	5908254817908			4000K	● 16cm	

MOSTRA LED

Oprawa liniowa
Linear light



Materiał: PC
Material: PC

Symbol Product no.	EAN	Zasilanie Power supply	Moc Rated power	Źródło światła Light source	Współczynnik CRI Color rendering index	Strumień świetlny Luminous flux	Temperatura barwowa Color temperature	Stopień ochrony Protection rating	Wymiary (szer./wys./gł. [mm]) Dimensions (W x H x D [mm])
AD-OP-6086LZM4	5908254819728	230V~, 50Hz	10W	LED SMD	≥80	800lm	4000K	IP20	300 / 70 / 22
AD-OP-6087LZM4	5908254817274	230V~, 50Hz	20W	LED SMD	≥80	1700lm	4000K	IP20	600 / 70 / 22
AD-OP-6088LZM4	5908254817281	230V~, 50Hz	30W	LED SMD	≥80	2700lm	4000K	IP20	900 / 75 / 25
AD-OP-6089LZM4	5908254817298	230V~, 50Hz	40W	LED SMD	≥80	3700lm	4000K	IP20	1200 / 70 / 22
AD-OP-6090LZM4	5908254819735	230V~, 50Hz	50W	LED SMD	≥80	4700lm	4000K	IP20	1500 / 75 / 25

BISE LED

Oprawa hermetyczna
Waterproof linear light



Stopień ochrony
Protection range



Materiał: PC
Material: polycarbonate

Symbol Product no.	EAN	Zasilanie Power supply	Moc Rated power	Źródło światła Light source	Współczynnik CRI Color rendering index	Strumień świetlny Luminous flux	Temperatura barwowa Color temperature	Stopień ochrony Protection rating	Wymiary (szer./wys./gł. [mm]) Dimensions (W x H x D [mm])
AD-OP-6065LPM4	5908254817786	230V~, 50Hz	36W	LED SMD	≥70	3250lm	4000K	IP65	1282 / 42,5 / 30
AD-OP-6066LPM4	5908254817793	230V~, 50Hz	45W	LED SMD	≥70	4100lm	4000K	IP65	1582 / 42,5 / 30

HYZ LED NEW

Oprawa hermetyczna
Waterproof linear light



Stopień ochrony
Protection range



Materiał: ABS/PC
Material: ABS/PC



Symbol Product no.	EAN	Zasilanie Power supply	Moc Rated power	Źródło światła Light source	Współczynnik CRI Color rendering index	Strumień świetlny Luminous flux	Temperatura barwowa Color temperature	Stopień ochrony Protection rating	szer./wys./gł. [mm] W x H x D [mm]
AD-OP-6125LPM4	5908254818141	230V~, 50Hz	18W	LED SMD	≥80	1800lm	4000K	IP65	600 / 76 / 66
AD-OP-6126LPM4	5908254818158	230V~, 50Hz	36W	LED SMD	≥80	3600lm	4000K	IP65	1200 / 76 / 66
AD-OP-6127LPM4	5908254818165	230V~, 50Hz	48W	LED SMD	≥80	4800lm	4000K	IP65	1500 / 76 / 66

OPRAWY SCHODOWE

STAIRCASE LUMINAIRE

Innowacyjny, elastyczny sposób montażu
pozwalający zamontować oprawę w każdej puszcze Ø60mm

Innovative, flexible installation
that suits any Ø60mm junction box

DRACO LED NEW

Oprawa schodowa podtynkowa
Flush-mounted staircase light fitting



AD-OS-6164L3/W
AD-OS-6164L4/W
AD-OS-6164L6/W



AD-OS-6164L3/B
AD-OS-6164L4/B
AD-OS-6164L6/B



AD-OS-6164L3/N
AD-OS-6164L4/N
AD-OS-6164L6/N

Symbol Product no.	EAN	Zasilanie Power supply	Moc Rated power	Strumień świetlny Luminous flux	Temperatura barwowa Color temperature	Kolor Color	Materiał Material	Wymiary (szer./wys./gł. [mm]) Dimensions (W/H/D [mm])
AD-OS-6164L3/W	5908254819124	12V DC	1,5W	30lm	3000K	biały white	stal steel	75 / 75 / 32.5
AD-OS-6164L4/W	5908254821059	12V DC	1,5W	30lm	4000K	biały white	stal steel	75 / 75 / 32.5
AD-OS-6164L6/W	5908254819155	12V DC	1,5W	30lm	6000K	biały white	stal steel	75 / 75 / 32.5
AD-OS-6164L3/B	5908254818707	12V DC	1,5W	30lm	3000K	czarny black	stal steel	75 / 75 / 32.5
AD-OS-6164L4/B	5908254821073	12V DC	1,5W	30lm	4000K	czarny black	stal steel	75 / 75 / 32.5
AD-OS-6164L6/B	5908254819131	12V DC	1,5W	30lm	6000K	czarny black	stal steel	75 / 75 / 32.5
AD-OS-6164L3/N	5908254818714	12V DC	1,5W	30lm	3000K	satyna satin	stal steel	75 / 75 / 32.5
AD-OS-6164L4/N	5908254821097	12V DC	1,5W	30lm	4000K	satyna satin	stal steel	75 / 75 / 32.5
AD-OS-6164L6/N	5908254819148	12V DC	1,5W	30lm	6000K	satyna satin	stal steel	75 / 75 / 32.5

DRACO LED NEW

Oprawa schodowa podtynkowa z czujnikiem ruchu PIR

Flush-mounted staircase light fitting with PIR sensor



AD-OS-6164LR4/W
AD-OS-6164LR6/W



AD-OS-6164LR3/B
AD-OS-6164LR4/B
AD-OS-6164LR6/B



AD-OS-6164LR3/N
AD-OS-6164LR4/N
AD-OS-6164LR6/N



Innowacyjny, elastyczny sposób montażu pozwalający zamontować oprawę w każdej puszcze Ø60mm

Innovative, flexible installation that suits any Ø60mm junction box

Symbol Product no.	EAN	Zasilanie Power supply	Moc Rated power	Strumień świetlny Luminous flux	Temperatura barwowa Color temperature	Kąt detekcji Detection angle	Zasięg detekcji Detection range	Zakres regulacji (LUX) Adjustment range (LUX)	Zakres regulacji (TIME) Adjustment range (TIME)	Kolor Color	Wymiary (szer./wys./gł. [mm]) Dimensions (W x H x D [mm])
AD-OS-6164LR4/W	5908254821066	12V DC	1,5W	30 lm	4000K	120°	2-3m	<0-25 lux	3-45s	biały white	75 / 75 / 45
AD-OS-6164LR6/W	5908254819780	12V DC	1,5W	30 lm	6000K	120°	2-3m	<0-25 lux	3-45s	biały white	75 / 75 / 32.5
AD-OS-6164LR3/B	5908254819742	12V DC	1,5W	30 lm	3000K	120°	2-3m	<0-25 lux	3-45s	czarny black	75 / 75 / 32.5
AD-OS-6164LR4/B	5908254821080	12V DC	1,5W	30 lm	4000K	120°	2-3m	<0-25 lux	3-45s	czarny black	75 / 75 / 32.5
AD-OS-6164LR6/B	5908254819766	12V DC	1,5W	30 lm	6000K	120°	2-3m	<0-25 lux	3-45s	czarny black	75 / 75 / 32.5
AD-OS-6164LR3/N	5908254819759	12V DC	1,5W	30 lm	3000K	120°	2-3m	<0-25 lux	3-45s	satyna satin	75 / 75 / 32.5
AD-OS-6164LR4/N	5908254821103	12V DC	1,5W	30 lm	4000K	120°	2-3m	<0-25 lux	3-45s	satyna satin	75 / 75 / 32.5
AD-OS-6164LR6/N	5908254819773	12V DC	1,5W	30 lm	6000K	120°	2-3m	<0-25 lux	3-45s	satyna satin	75 / 75 / 32.5



NAŚWIETLACZE LED

LED FLOODLIGHTS



LUX LED

Naświetlacz solarny z czujnikiem ruchu PIR

Solar floodlight with PIR sensor

Główne cechy / Main features

Czujnik ruchu PIR
PIR Motion sensor



Stopień ochrony
Protection rating

IP65

Źródło światła: LED SMD
Light source: LED SMD



Panel solarny: polikrystaliczny
Solar panel: polycrystalline



Symbol Product no.	EAN	Zasilanie Power supply	Moc Rated power	Kąt detekcji Detection angle	Zasięg detekcji Detection range	Współczynnik CRI Color rendering index	Strumień światłny Luminous flux	Temperatura barwowa Color temperature	Wymiary (szer./wys./gt. [mm]) Dimensions (W x H x D [mm])
AD-SL-6108BLR4	5908254817687	2x1500mAh 3,7V Li-ion	5W	120°	max. 6m	≥80	500lm	4000K	217,4 / 149,3 / 33,7

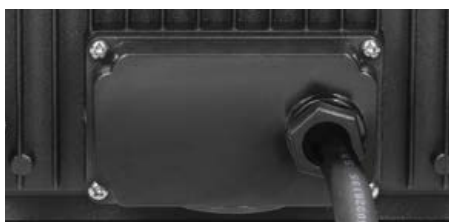

BULLED / BULLED S

System łączenia przewodu z oprawą zapewnia klasę szczelności IP65

System of cable connection with the luminaire ensures IP65 protection.

BULLED

Naświetlacze LED

LED floodlights



AD-NL-6153BLR4



AD-NL-6136BL4



AD-NL-6137BL4



AD-NL-6138BL4



Źródło światła: LED SMD
Light source: LED SMD



Kostka przyłączeniowa zamiast przewodu zasilającego
Terminal block instead of power wire



Zasilanie: 230V~, 50Hz
Power supply: 230V~, 50Hz



Temperatura barwowa: 4000K
Color temperature: 4000K



Współczynnik CRI: ≥80
Color rendering index: ≥80

Symbol Product no.	EAN	Moc Rated power	Kąt detekcji Detection angle	Zasięg detekcji Detection range	Czujnik ruchu Motion sensor	Strumień świetlny Luminous flux	Zakres regulacji (LUX) Adjustment range (LUX)	Zakres regulacji (TIME) Adjustment range (TIME)	Stopień ochrony Protection rating	Wymiary (szer./wys./gt. [mm]) Dimensions (W x H x D [mm])
AD-NL-6153BL4	5908254817366	10W	-	-	-	800lm	-	-	IP65	104 / 72 / 43
AD-NL-6136BL4	5908254817311	20W	-	-	-	1600lm	-	-	IP65	121 / 82 / 43
AD-NL-6137BL4	5908254817328	30W	-	-	-	2400lm	-	-	IP65	155 / 105 / 43
AD-NL-6138BL4	5908254817342	50W	-	-	-	4000lm	-	-	IP65	190 / 129 / 46

BULLED S

Naświetlacze LED z czujnikiem ruchu PIR
LED floodlights with PIR sensor



AD-NL-6153BLR4



AD-NL-6136BLR4



AD-NL-6137BLR4



AD-NL-6138BLR4

Regulacja zasięgu detekcji SENS
Adjustment of detection range (SENS)



Temperatura barwowa: 4000K
Color temperature: 4000K



Współczynnik CRI: ≥ 80
Color rendering index: ≥ 80



Źródło światła: LED SMD
Light source: LED SMD



Kostka przyłączeniowa zamiast przewodu zasilającego
Terminal block instead of power wire



Zasilanie: 230V~, 50Hz
Power supply: 230V~, 50Hz



Symbol Product no.	EAN	Moc Rated power	Kąt detekcji Detection angle	Zasięg detekcji Detection range	Czujnik ruchu Motion sensor	Strumień światłny Luminous flux	Zakres regulacji (LUX) Adjustment range (LUX)	Zakres regulacji (TIME) Adjustment range (TIME)	Stopień ochrony Protection rating	Wymiary (szer./wys./gt. [mm]) Dimensions (W x H x D [mm])
AD-NL-6153BLR4	5908254818851	10W	120°	4-8m	•	800lm	<10—2000 lux	10s±3s-10min±3	IP44	105 / 75 / 127
AD-NL-6136BLR4	5908254819308	20W	120°	4-8m	•	1600lm	<10—2000 lux	10s±3s-10min±3	IP44	120 / 75 / 135
AD-NL-6137BLR4	5908254817335	30W	120°	4-8m	•	2400lm	<10—2000 lux	10s±3s-10min±3	IP44	155 / 75 / 158
AD-NL-6138BLR4	5908254817359	50W	120°	4-8m	•	4000lm	<10—2000 lux	10s±3s-10min±3	IP44	190 / 76 / 185



AD-NL-6148WLR4



AD-NL-6148WLR4



TOS LED

Naświetlacze ogrodowe Garden floodlights



Kostka przyłączeniowa zamiast przewodu zasilającego
Terminal block instead of power wire



Zasilanie: 230V~, 50Hz
Power supply: 230V~, 50Hz



Temperatura barwowa: 4000K
Color temperature: 4000K



Współczynnik CRI: ≥ 85
Color rendering index: ≥ 80



Źródło światła: LED SMD
Light source: LED SMD



Stopień ochrony
Protection rating

Symbol Product no.	EAN	Moc Rated power	Kąt detekcji Detection angle	Zasięg detekcji Detection range	Kolor Color	Strumień światłowy Luminous flux	Zakres regulacji (LUX) Adjustment range (LUX)	Zakres regulacji (TIME) Adjustment range (TIME)	Wymiary (szer./wys./gt. [mm]) Dimensions (W x H x D [mm])
AD-NL-6148WL4	5908254817472	30W	-	-	biały white	2200lm	-	-	225 / 187 / 199
AD-NL-6148BL4	5908254817465	30W	-	-	czarny black	2200lm	-	-	225 / 187 / 199



AD-NL-6148WLR4



AD-NL-6148BLR4

TOS LED

Naświetlacze ogrodowe z czujnikiem ruchu PIR

Garden floodlights with PIR sensor

Współczynnik CRI: ≥ 85
Color rendering index: ≥ 80



Źródło światła: LED SMD
Light source: LED SMD



Stopień ochrony
Protection rating



Regulacja zasięgu detekcji (SENS)
Adjustment of detection range (SENS)



Kostka przyłączeniowa zamiast przewodu zasilającego
Terminal block instead of power wire



Zasilanie: 230V~, 50Hz
Power supply: 230V~, 50Hz



Temperatura barwowa: 4000K
Color temperature: 4000K



Czujnik ruchu PIR
PIR motion sensor



Symbol Product no.	EAN	Moc Rated power	Kąt widzenia Detection angle	Zasięg detekcji Detection range	Kolor Color	Strumień światłowy Luminous flux	Zakres regulacji (LUX) Adjustment range (LUX)	Zakres regulacji (TIME) Adjustment range (TIME)	Wymiary (szer./wys./gł. [mm]) Dimensions (W x H x D [mm])
AD-NL-6148WLR4	5908254817489	30W	240°	5-10m	biały white	2200lm	<3–2000 lux	10s±3s~15min±2	225 / 187 / 199
AD-NL-6148BLR4	5908254819247	30W	240°	5-10m	czarny black	2200lm	<3–2000 lux	10s±3s~15min±2	225 / 187 / 199

OPRAWY OGRODOWE

GARDEN LUMINAIRES



PIRYT LED

Oprawa ogrodowa
Garden luminaire

Główne cechy / Main features

**IP54
IK10**

Stopień ochrony
Protection rating



Zasilanie: 230V~, 50Hz
Power supply: 230V~, 50Hz



Źródło światła: LED SMD
Light source: LED SMD



Czujnik ruchu PIR
PIR motion sensor



Kąt detekcji: 140°
Detection angle: 140°



AD-OP-6109WLPM4



AD-OP-6109BLPM4



AD-OP-6109GLPM4



AD-OP-6109WLPMR4



AD-OP-6109BLPMR4



AD-OP-6109GLPMR4

Symbol Product no.	EAN	Moc Rated power	Strumień światlny Luminous flux	Temperatura barwowa Color temperature	Zasięg detekcji Detection range	Zakres regulacji (LUX) Adjustment range (LUX)	Zakres regulacji (TIME) Adjustment range (TIME)	Wymiary (szer./wys./gi. [mm]) Dimensions (W x H x D [mm])
AD-OP-6109WLPM4	5908254817762	10W	800lm	4000K	-	-	-	188 / 250 / 66
AD-OP-6109BLPM4	5908254817755	10W	800lm	4000K	-	-	-	188 / 250 / 66
AD-OP-6109GLPM4	5908254817779	10W	800lm	4000K	-	-	-	188 / 250 / 66
AD-OP-6109WLPMR4	5908254818530	10W	800lm	4000K	9m	<3-2000 lux	10s±3s-5min±2	188 / 250 / 66
AD-OP-6109BLPMR4	5908254818547	10W	800lm	4000K	9m	<3-2000 lux	10s±3s-5min±2	188 / 250 / 66
AD-OP-6109GLPMR4	5908254818585	10W	800lm	4000K	9m	<3-2000 lux	10s±3s-5min±2	188 / 250 / 66



AD-OP-6204WLPM4



AD-OP-6204BLPM4



AD-OP-6204GLPM4



AD-OP-6204WLPMR4



AD-OP-6204BLPMR4



AD-OP-6204GLPMR4

FRENIT LED

Oprawa ogrodowa
Garden luminaire

Główne cechy / Main features

Stopień ochrony
Protection rating

IP65
IK10

Zasilanie: 230V~, 50Hz
Power supply: 230V~, 50Hz



Źródło światła: LED SMD
Light source: LED SMD



Czujnik ruchu PIR
PIR motion sensor



Kąt detekcji: 140°
Detection angle: 140°



Symbol Product no.	EAN	Moc Rated power	Strumień światłowy Luminous flux	Temperatura barwowa Color temperature	Zasięg detekcji Detection range	Zakres regulacji (LUX) Adjustment range (LUX)	Zakres regulacji (TIME) Adjustment range (TIME)	Wymiary (szer./wys./gł. [mm]) Dimensions (W x H x D [mm])
AD-OP-6204WLPM4	5908254822124	20W	1800lm	4000K	-	-	-	250 / 188 / 66
AD-OP-6204BLPM4	5908254822117	20W	1800lm	4000K	-	-	-	250 / 188 / 66
AD-OP-6204GLPM4	5908254822131	20W	1800lm	4000K	-	-	-	250 / 188 / 66
AD-OP-6204WLPMR4	5908254815737	20W	1800lm	4000K	9m	<3-2000 lux	10s±3s-5min±1	250 / 188 / 66
AD-OP-6204BLPMR4	5908254815744	20W	1800lm	4000K	9m	<3-2000 lux	10s±3s-5min±1	250 / 188 / 66
AD-OP-6204GLPMR4	5908254815751	20W	1800lm	4000K	9m	<3-2000 lux	10s±3s-5min±1	250 / 188 / 66

NEFRYT LED

Oprawy ogrodowe

Garden luminaire



AD-OP-6110WLPM4
AD-OP-6147WLPM4



AD-OP-6110BLPM4
AD-OP-6147BLPM4



AD-OP-6110GLPM4
AD-OP-6147GLPM4



AD-OP-6110WLPMR4
AD-OP-6147WLPMR4



AD-OP-6110BLPMR4
AD-OP-6147BLPMR4



AD-OP-6110GLPMR4
AD-OP-6147GLPMR4



Zasilanie: 230V~, 50Hz
Power supply: 230V~, 50Hz



Temperatura barwowa: 4000K
Color temperature: 4000K



Czujnik ruchu PIR
PIR motion sensor



Źródło światła: LED SMD
Light source: LED SMD



Stopień ochrony
Protection rating

Symbol Product no.	EAN	Moc Rated power	Kąt detekcji Detection angle	Współczynnik CRI Color rendering index	Strumień światłny Luminous flux	Czujnik ruchu Motion sensor	Zasięg detekcji Detection range	Zakres regulacji (LUX) Adjustment range (LUX)	Zakres regulacji (TIME) Adjustment range (TIME)	Kolor Color	szer./wys./gt. [mm] W x H x D [mm]
AD-OP-6110WLPM4	5908254819698	10W	-	≥85	800lm	-	-	-	-	biały white	119,2 / 212,2 / 44,5
AD-OP-6110BLPM4	5908254818592	10W	-	≥85	800lm	-	-	-	-	czarny black	119,2 / 212,2 / 44,5
AD-OP-6110GLPM4	5908254819674	10W	-	≥85	800lm	-	-	-	-	szary grey	119,2 / 212,2 / 44,5
AD-OP-6147WLPM4	5908254817564	15W	-	≥85	1100lm	-	-	-	-	biały white	119,2 / 212,2 / 44,5
AD-OP-6147BLPM4	5908254818646	15W	-	≥85	1100lm	-	-	-	-	czarny black	119,2 / 212,2 / 44,5
AD-OP-6147GLPM4	5908254818660	15W	-	≥85	1100lm	-	-	-	-	szary grey	119,2 / 212,2 / 44,5
AD-OP-6110WLPMR4	5908254817496	10W	140°	≥85	800lm	•	9m	<3-2000 lux	10s±3s-5min±1	biały white	119,2 / 212,2 / 44,5
AD-OP-6110BLPMR4	5908254818608	10W	140°	≥85	800lm	•	9m	<3-2000 lux	10s±3s-5min±1	czarny black	119,2 / 212,2 / 44,5
AD-OP-6110GLPMR4	5908254819681	10W	140°	≥85	800lm	•	9m	<3-2000 lux	10s±3s-5min±1	szary grey	119,2 / 212,2 / 44,5
AD-OP-6147WLPMR4	5908254817571	15W	140°	≥85	1100lm	•	9m	<3-2000 lux	10s±3s-5min±1	biały white	119,2 / 212,2 / 44,5
AD-OP-6147BLPMR4	5908254818653	15W	140°	≥85	1100lm	•	9m	<3-2000 lux	10s±3s-5min±1	czarny black	119,2 / 212,2 / 44,5
AD-OP-6147GLPMR4	5908254818677	15W	140°	≥85	1100lm	•	9m	<3-2000 lux	10s±3s-5min±1	szary grey	119,2 / 212,2 / 44,5

AGAT LED

Oprawy ogrodowe
Garden luminaire



AD-OP-6111WLPM4
AD-OP-6112WLPM4



AD-OP-6111BLPM4
AD-OP-6112BLPM4



AD-OP-6111GLPM4
AD-OP-6112GLPM4



AD-OP-6111WLPMR4
AD-OP-6112WLPMR4



AD-OP-6111BLPMR4
AD-OP-6112BLPMR4



AD-OP-6111GLPMR4
AD-OP-6112GLPMR4

Czujnik ruchu PIR
PIR motion sensor



Temperatura barwowa: 4000K
Color temperature: 4000K



Zasilanie: 230V~, 50Hz
Power supply: 230V~, 50Hz



Stopień ochrony
Protection rating



Źródło światła: LED SMD
Light source: LED SMD



Symbol Product no.	EAN	Moc Rated power	Kąt detekcji Detection angle	Współczynnik CRI Color rendering index	Strumień światlny Luminous flux	Czujnik ruchu Motion sensor	Zasięg detekcji Detection range	Zakres regulacji (LUX) Adjustment range (LUX)	Zakres regulacji (TIME) Adjustment range (TIME)	Kolor Color	szer./wys./gt. [mm] W x H x D [mm]
AD-OP-6111WLPM4	5908254822285	10W	-	≥85	800lm	-	-	-	-	biały white	Ø210 / 49
AD-OP-6111BLPM4	5908254822273	10W	-	≥85	800lm	-	-	-	-	czarny black	Ø210 / 49
AD-OP-6111GLPM4	5908254819254	10W	-	≥85	800lm	-	-	-	-	szary grey	Ø210 / 49
AD-OP-6112WLPM4	5908254818615	15W	-	≥85	1100lm	-	-	-	-	biały white	Ø210 / 49
AD-OP-6112BLPM4	5908254817526	15W	-	≥85	1100lm	-	-	-	-	czarny black	Ø210 / 49
AD-OP-6112GLPM4	5908254819278	15W	-	≥85	1100lm	-	-	-	-	szary grey	Ø210 / 49
AD-OP-6111WLPMR4	5908254817519	10W	140°	≥85	850lm	•	9m	<3–2000 lux	10s±3s~5min±1	biały white	Ø210 / 49
AD-OP-6111BLPMR4	5908254817502	10W	140°	≥85	850lm	•	9m	<3–2000 lux	10s±3s~5min±1	czarny black	Ø210 / 49
AD-OP-6111GLPMR4	5908254819261	10W	140°	≥85	850lm	•	9m	<3–2000 lux	10s±3s~5min±1	szary grey	Ø210 / 49
AD-OP-6112WLPMR4	5908254817540	15W	140°	≥85	1200lm	•	9m	<3–2000 lux	10s±3s~5min±1	biały white	Ø210 / 49
AD-OP-6112BLPMR4	5908254817533	15W	140°	≥85	1200lm	•	9m	<3–2000 lux	10s±3s~5min±1	czarny black	Ø210 / 49
AD-OP-6112GLPMR4	5908254819285	15W	140°	≥85	1200lm	•	9m	<3–2000 lux	10s±3s~5min±1	szary grey	Ø210 / 49

ENYE LED

Oprawa elewacyjna
Outdoor wall light



Główne cechy / Main features

Stopień IK
IK rating

IK08

Stopień ochrony
Protection rating

IP65

Temperatura barwowa: 4000K
Color temperature: 4000K



Materiał klosza: ABS+PC
Lampshade material: ABS+PC



Symbol Product no.	EAN	Zasilanie Power supply	Źródło światła Light source	Moc Rated power	Strumień świetlny Luminous flux	Współczynnik CRI Color rendering index	Wymiary (szer./wys./gł. [mm]) Dimensions (W x H x D [mm])
AD-OP-6190L4	5908254817724	230V~, 50Hz	LED SMD	1,5W	60lm	≥80	100 / 33 / 60

ENYE LED

Oprawa elewacyjna
Outdoor wall light



Główne cechy / Main features

Stopień IK
IK rating

IK08

Stopień ochrony
Protection rating

IP65

Temperatura barwowa: 4000K
Color temperature: 4000K



Materiał klosza: ABS+PC
Lampshade material: ABS+PC



Symbol Product no.	EAN	Zasilanie Power supply	Źródło światła Light source	Moc Rated power	Strumień świetlny Luminous flux	Współczynnik CRI Color rendering index	Wymiary (szer./wys./gł. [mm]) Dimensions (W x H x D [mm])
AD-OP-6191L4	5908254817731	230V~, 50Hz	LED SMD	3W	170lm	≥80	160 / 70 / 33



RIOLIT LED

Oprawa ogrodowa z czujnikiem ruchu PIR
Garden luminaire with PIR sensor



AD-OP-6206GLPMR4



AD-OP-6206BLPMR4



AD-OP-6206WLPMR4

Główne cechy / Main features

- IP65 Stopień ochrony
Protection rating
- Czujnik ruchu PIR
PIR motion sensor
- Współczynnik CRI: ≥ 85
Color rendering index: ≥ 85

- Materiał klosza: PC
Lampshade material: PC
- Temperatura barwowa: 4000K
Color temperature: 4000K

Symbol Product no.	EAN	Moc Rated power	Kąt detekcji Detection angle	Zasięg detekcji Detection range	Kolor Color	Strumień światlny Luminous flux	Zakres regulacji (LUX) Adjustment range (LUX)	Zakres regulacji (TIME) Adjustment range (TIME)	Wymiary (szer./wys./gt. [mm]) Dimensions (W x H x D [mm])
AD-OP-6206WLPMR4	5908254815799	15W	140°	9m	biały white	1100lm	<3–2000 lux	10s±3s–5min±1	170,7 / 159,2 / 80
AD-OP-6206BLPMR4	5908254815805	15W	140°	9m	czarny black	1100lm	<3–2000 lux	10s±3s–5min±1	170,7 / 159,2 / 80
AD-OP-6206GLPMR4	5908254815812	15W	140°	9m	szary grey	1100lm	<3–2000 lux	10s±3s–5min±1	170,7 / 159,2 / 80



HOWLIT LED

Oprawa ogrodowa z czujnikiem ruchu PIR
Garden luminaire with PIR sensor



AD-OP-6205WLPMR4



AD-OP-6205BLPMR4



AD-OP-6205GLPMR4

Źródło światła: LED SMD
Light source: LED SMD



Kąt detekcji: 140°
Detection angle: 140°



Główne cechy / Main features

Stopień ochrony
Protection rating

IP65

Zasilanie: 230V~, 50Hz
Power supply: 230V~, 50Hz



Czujnik ruchu PIR
PIR motion sensor





Symbol Product no.	EAN	Moc Rated power	Strumień świetlny Luminous flux	Temperatura barwowa Color temperature	Zasięg detekcji Detection range	Zakres regulacji (LUX) Adjustment range (LUX)	Zakres regulacji (TIME) Adjustment range (TIME)	Wymiary (szer./wys./gt. [mm]) Dimensions (W x H x D [mm])
AD-OP-6205WLPMR4	5908254815768	20W	1800lm	4000K	9m	<3–2000 lux	10s±3s–5min±1	196 / 149,3 / 82
AD-OP-6205BLPMR4	5908254815775	20W	1800lm	4000K	9m	<3–2000 lux	10s±3s–5min±1	196 / 149,3 / 82
AD-OP-6205GLPMR4	5908254815782	20W	1800lm	4000K	9m	<3–2000 lux	10s±3s–5min±1	196 / 149,3 / 82



SPINEL LED

Oprawa ogrodowa z czujnikiem ruchu PIR
Garden luminaire with PIR sensor

Główne cechy / Main features

- 
IP54 Stopień ochrony
Protection rating
- 
Czujnik ruchu PIR
PIR motion sensor
- 
Współczynnik CRI: ≥85
Color rendering index: ≥85



AD-OP-6119WLPMR4



AD-OP-6119BLPMR4



AD-OP-6119GLPMR4



Materiał klosza: PC
Lampshade material: PC



Temperatura barwowa: 4000K
Color temperature: 4000K

Symbol Product no.	EAN	Moc Rated power	Kąt detekcji Detection angle	Zasięg detekcji Detection range	Kolor Color	Strumień świetlny Luminous flux	Zakres regulacji LUX Adjustment range (LUX)	Zakres regulacji TIME Adjustment range (TIME)	Wymiary (szer./wys./gt. [mm]) Dimensions (W x H x D [mm])
AD-OP-6119WLPMR4	5908254817557	10W	140°	9m	biały white	800lm	<3–2000 lux	10s±3s–5min±1	289 / 147 / 90
AD-OP-6119BLPMR4	5908254818622	10W	140°	9m	czarny black	800lm	<3–2000 lux	10s±3s–5min±1	289 / 147 / 90
AD-OP-6119GLPMR4	5908254818639	10W	140°	9m	szary grey	800lm	<3–2000 lux	10s±3s–5min±1	289 / 147 / 90

Główne cechy / Main features



Podwójne źródło światła: 190lm/30lm
Double light source: 190lm/30lm



Stopień ochrony
Protection rating



Zasilanie: 1200mAh Li-ion
Power supply: 1200mAh Li-ion



Źródło światła: LED SMD
Light source: LED SMD



Kąt detekcji: 120°
Detection angle: 120°



Czujnik ruchu PIR
PIR motion sensor



AD-SL-6083WLR4



AD-SL-6083BLR4



SILOE LED

Lampa solarna z czujnikiem ruchu PIR
Solar garden luminaire with PIR sensor

Symbol Product no.	EAN	Moc Rated power	Strumień świetlny Luminous flux	Temperatura barwowa Color temperature	Zasięg detekcji Detection range	Wymiary (szer./wys./gł. [mm]) Dimensions (W x H x D [mm])
AD-SL-6083WLR4	5908254821813	1,5W	220lm	4000K	<6m	96 / 144,5 / 79
AD-SL-6083BLR4	5908254821806	1,5W	220lm	4000K	<6m	96 / 144,5 / 79

Główne cechy / Main features



Podwójne źródło światła: 240lm/20lm
Double light source: 240lm/20lm



Stopień ochrony
Protection rating



Zasilanie: 1200mAh Li-ion
Power supply: 1200mAh Li-ion



Źródło światła: LED SMD
Light source: LED SMD



Kąt detekcji: 120°
Detection angle: 120°



Czujnik ruchu PIR
PIR motion sensor



NOCTURNE LED

Lampa solarna z czujnikiem ruchu PIR
Solar garden luminaire with PIR sensor

Symbol Product no.	EAN	Moc Rated power	Strumień świetlny Luminous flux	Temperatura barwowa Color temperature	Zasięg detekcji Detection range	Wymiary (szer./wys./gł. [mm]) Dimensions (W x H x D [mm])
AD-SL-6107WLR4	5908254823077	2W	260lm	4000K	<6m	104,3 / 200 / 89,7

OŚWIETLENIE ROBOCZE

WORK LIGHTING



ROBOTIX SLIM LED

Naświetlacz roboczy z funkcją powerbank
Work floodlight with powerbank function



Funkcja powerbank
Powerbank function

Główne cechy / Main features

- IP44** Stopień ochrony
Protection rating
-  Pojemność akumulatora: 4400mAh
Battery capacity: 4400mAh
-  Ilość trybów pracy: 3
Number of modes: 3
-  Materiał klosza: PC
Lampshade material: PC

Symbol Product no.	EAN	Zasilanie Power supply	Moc Rated power	Strumień świetlny Luminous flux	Temp. barwowa Color temp.	Wymiary (szer./wys./gł. [mm]) Dimensions (W x H x D [mm])
AD-NR-6151L4	5908254816390	3,7V Li-ion 4400mAh	20W	1250lm	4000K	172 / 127 / 46

Latarka warsztatowa LED

LED work light

Główne cechy / Main features

IP44

Stopień ochrony
Protection ratingHak
Hook

Symbol Product no.	EAN	Zasilanie Power supply	Moc Rated power	Strumień świetlny Luminous flux	Temp. barwowa Color temp.	Długość przewodu Wire length	Wymiary (szer./wys./gt. [mm]) Dimensions (W x H x D [mm])
AD-NR-6069L6	5908254816185	230V~, 50Hz	8,5W	500lm	6000K	5m	Ø30 / 500

Główne cechy / Main features

IP44

Stopień ochrony
Protection ratingPojemność akumulatora: 800mAh
Battery capacity: 800mAhHak
Hook

Akumulatorowa latarka warsztatowa LED

LED rechargeable work light



Symbol Product no.	EAN	Zasilanie Power supply	Moc Rated power	Strumień świetlny Luminous flux	Temp. barwowa Color temp.	Wymiary (szer./wys./gt. [mm]) Dimensions (W x H x D [mm])
AD-NR-6093L6	5908254802676	230V~, 50Hz	8,5W	500lm	6000K	45 / 448 / 42

STATIX naświetlacz roboczy

STATIX floodlight

Główne cechy / Main features

IP65

Stopień ochrony
Protection rating

Symbol Product no.	EAN	Zasilanie Power supply	Moc Rated power	Strumień świetlny Luminous flux	Temp. barwowa Color temp.	Długość przewodu Length of the wire	Wymiary (szer./wys./gt. [mm]) Dimensions (W x H x D [mm])
AD-NR-6196L6	5908254823091	230V~, 50Hz	30W	2400lm	6000K	2,5m	160 / 150 / 210

BATRI LED

Naświetlacz roboczy, przenośny, z akumulatorem

Work floodlight, portable, with battery



Główne cechy / Main features

Stopień ochrony
Protection rating

IP65

Ilość trybów pracy: 2
Number of modes: 2



Materiał klosza: szkło hartowane
Lampshade material: tempered glass



Symbol Product no.	EAN	Zasilanie Power supply	Pojemność akum. Battery capacity	Moc Rated power	Strumień świetlny Luminous flux	Temp. barwowa Color temp.	Wymiary (szer./wys./gł. [mm]) Dimensions (W x H x D [mm])
AD-NR-6201L6	5908254816802	3,7V Li-Po bateria 3.7V Li-Po battery	2200mAh	10W	800 lm	6500K	175 / 165 / 243

BATRI LED

Naświetlacz roboczy, przenośny, z akumulatorem

Work floodlight, portable, with battery



Główne cechy / Main features

Stopień ochrony
Protection rating

IP65

Ilość trybów pracy: 2
Number of modes: 2



Materiał klosza: szkło hartowane
Lampshade material: tempered glass



Symbol Product no.	EAN	Zasilanie Power supply	Pojemność akum. Battery capacity	Moc Rated power	Strumień świetlny Luminous flux	Temp. barwowa Color temp.	Wymiary (szer./wys./gł. [mm]) Dimensions (W x H x D [mm])
AD-NR-6202L6	5908254816819	8.4V DC	4400mAh	20W	1600 lm	6500K	223 / 185 / 285

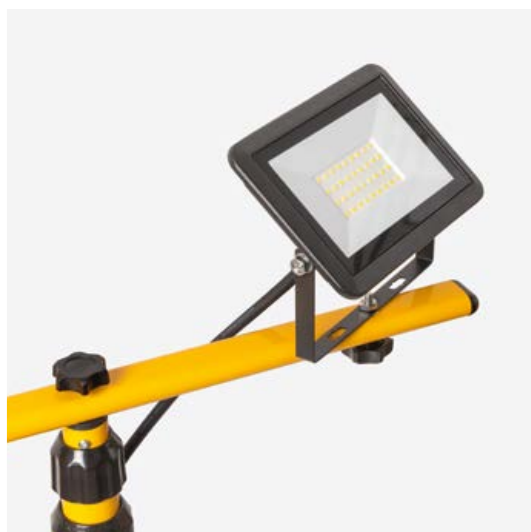
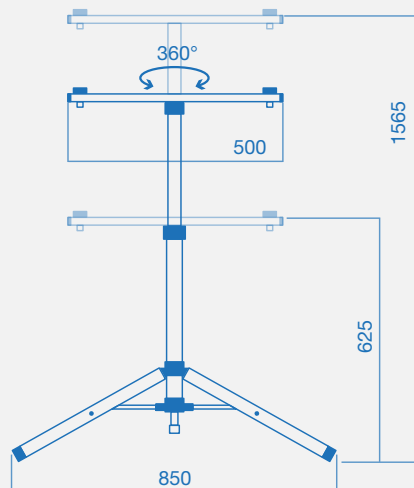

Zestaw naświetlaczy

2 x BULLED + statyw + przewód

BULLED set of two floodlights
with double tripod and 2m cable



AD-NL-6137



2 x
AD-NL-6137BL4



AD-NL-6136ST



AD-NL-6136PZ

Mocowanie na kabel
Mocowanie na kabel



AD-NL-6138



2 x
AD-NL-6138BL4



AD-NL-6136ST



AD-NL-6136PZ

Źródło światła: LED SMD
Light source: LED SMD



Współczynnik CRI: ≥ 80
Color rendering index: ≥ 80



Symbol Product no.	EAN	Zasilanie Power supply	Moc Rated power	Strumień światłny Luminous flux	Temp. barwowa Color temp.	Stopień ochrony Protection rating	Długość przewodu Cable length	Zakres regulacji Adjustment range	Materiał Material	Kolor Color	szer./wys./gł. [mm] W x H x D [mm]
AD-NL-6137BL4	5908254817328	230V~, 50Hz	30W	2400lm	4000K	IP65	-	-	-	-	155 / 105 / 43
AD-NL-6138BL4	5908254817342	230V~, 50Hz	50W	4000lm	4000K	IP65	-	-	-	-	190 / 129 / 46
AD-NL-6136ST	5908254817885	-	-	-	-	-	-	625-1565mm	metal	żółty yellow	850 / 850 / 1565
AD-NL-6136ST/B	5908254823213	-	-	-	-	-	-	625-1565mm	metal	czarny black	850 / 850 / 1565
AD-NL-6136PZ	5908254823329	230V~, 50Hz	-	-	-	-	2m	-	-	-	-

HIGHBAY

Główne cechy / Main features

IP65

Stopień ochrony
Protection rating



Źródło światła: LED SMD
Light source: LED SMD



Współczynnik CRI: ≥ 80
Colour rendering index: ≥ 80

HORIN LED

Oprawy typu high-bay
High-bay industrial lights



Symbol Product no.	EAN	Zasilanie Power supply	Moc Rated power	Strumień świetlny Luminous flux	Temperatura barwowa Color temperature	Stopień ochrony Protection rating	Materiał Material	szer./wys./gl. [mm] W x H x D [mm]
AD-OP-6131L4	5908254818172	230V~, 50Hz	60W	5400lm	4000K	IP65	aluminium/szko aluminium/glass	240 / 72,5 / 132,5
AD-OP-6132L4	5908254819872	230V~, 50Hz	100W	9000lm	4000K	IP65	aluminium/szko aluminium/glass	300 / 75 / 135
AD-OP-6133L4	5908254821356	230V~, 50Hz	150W	13500lm	4000K	IP65	aluminium/szko aluminium/glass	350 / 82,5 / 142,5
AD-OP-6134L4	5908254823084	230V~, 50Hz	200W	18000lm	4000K	IP65	aluminium/szko aluminium/glass	390 / 89,5 / 149,5

Źródło światła LED T8

LED T8 tube

Główne cechy / Main features



Źródło światła: LED SMD
Light source: LED SMD



Trzonek G13
G13 base



Materia: szkło
Material: glass



D

Symbol Product no.	EAN	Zasilanie Power supply	Moc Rated power	Strumień świetlny Luminous flux	Temp. barwowa Color temp.	Wymiary (szer./wys./gł. [mm]) Dimensions (W x H x D [mm])
AD-SW-6203L4	5908254823107	230V~, 50Hz	18W	2700lm	4000K	1210 / 28

AVIS LED, panel świetlny

AVIS LED light panel

Główne cechy / Main features



Źródło światła: LED SMD
Light source: LED SMD



Neodymowe magnesy
Neodymium magnets



Współczynnik CRI: ≥ 80
Colour rendering index: ≥ 80



AD-SW-6115L4

F

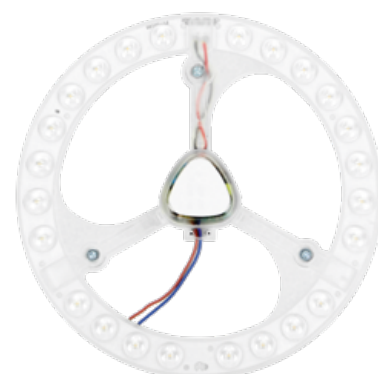

AD-SW-6124L4

F

Symbol Product no.	EAN	Zasilanie Power supply	Moc Rated power	Strumień świetlny Luminous flux	Temp. barwowa Color temp.	Wymiary (szer./wys./gł. [mm]) Dimensions (W x H x D [mm])
AD-SW-6115L4	5908254817410	230V~, 50Hz	12W	1050lm	4000K	Ø141 / 24
AD-SW-6124L4	5908254821882	230V~, 50Hz	24W	2200lm	4000K	Ø228 / 24



Możliwość cięcia taśmy:
Cutting option:

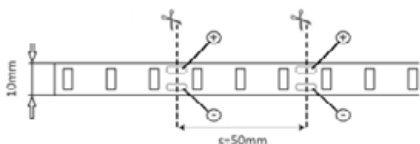

SMD 60LED/m

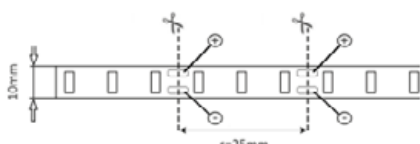

SMD 120LED/m

Współpraca ze ściemniaczem
Compatible with dimmer



Oryginalne taśmy 3M
Original 3M tapes



Równomierne oświetlenie
Even light distribution



Dwustronne zasilanie
Double power supply



Wysoki stopień odprowadzania ciepła
High level of heat dissipation



Symbol Product no.	EAN	Zasilanie Power supply	Moc Rated power	Źródło światła Light source	Współczynnik CRI Color rendering index	Strumień świetlny Luminous flux	Temperatura barwowa Color temperature	Stopień ochrony Protection rating	szer./wys./gl. [mm] W x H x D [mm]	
AD-TL-6184L3	5908254823282	12V DC	4,8W/m	SMD 60LED/m	≥80	500lm/m	3000K	IP20	10 / 5000	F
AD-TL-6184L6	5908254823114	12V DC	4,8W/m	SMD 60LED/m	≥80	540lm/m	6000K	IP20	10 / 5000	F
AD-TL-6185L3	5908254823299	12V DC	4,8W/m	SMD 60LED/m	≥80	400lm/m	3300-3500K	IP65	10 / 5000	G
AD-TL-6185L6	5908254823121	12V DC	4,8W/m	SMD 60LED/m	≥80	440lm/m	6000K	IP65	10 / 5000	G
AD-TL-6186L3	5908254823138	12V DC	9,6W/m	SMD 120LED/m	≥80	1000lm/m	3000K	IP20	10 / 5000	F
AD-TL-6186L6	5908254823145	12V DC	9,6W/m	SMD 120LED/m	≥80	1080lm/m	6000K	IP20	10 / 5000	F
AD-TL-6187L3	5908254823152	12V DC	9,6W/m	SMD 120LED/m	≥80	800lm/m	3300-3500K	IP65	10 / 5000	G
AD-TL-6187L6	5908254823169	12V DC	9,6W/m	SMD 120LED/m	≥80	880lm/m	6000K	IP65	10 / 5000	G

Czujnik ruchu PIR do paska LED 120°

LED strip motion sensor, 120°



Symbol Product no.	EAN	Zasilanie Power supply	Zasięg Range	Maks. obciążenie Max. load	Stopień ochrony Protection rating	Regulacja czasu świecenia TIME Adjustment of lighting time (TIME)	Wymiary (szer./wys./gł. [mm]) Dimensions (W x H x D [mm])
OR-CR-260	5900378653394	12-24V DC	10m	60W LED	IP20	30 sec./120 sec./360 sec.	50 / 37 / 31

Łącznik Z-Z do taśm LED 10mm, 10 szt.

Z-Z LED strip connector, 10mm, 10 pcs.

Symbol Product no.	EAN	Zasilanie Power supply	Stopień ochrony Protection rating
AD-TL-6188/Z-Z/10	5908254819094	12V DC	IP20



Łącznik Z-P do taśm LED 10mm, 10 szt.

Z-P LED strip connector 10mm, 10 pcs.

Symbol Product no.	EAN	Zasilanie Power supply	Stopień ochrony Protection rating
AD-TL-6188/Z-P/10	5908254819070	12V DC	IP20



Łącznik Z-P-Z do taśm LED 10mm, 10 szt.

Z-P-Z LED strip connector 10mm, 10 pcs.

Symbol Product no.	EAN	Zasilanie Power supply	Stopień ochrony Protection rating
AD-TL-6188/Z-P-Z/10	5908254819087	12V DC	IP20

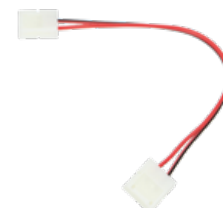

Wtyk zasilania do taśm LED DC 5.5/2.1 męski, 10 szt.

LED strip male power plug DC 5.5/2.1, 10 pcs.

Symbol Product no.	EAN	Zasilanie Power supply	Stopień ochrony Protection rating
AD-TL-6188/W-Z/10	5908254819056	12V DC	IP20



Łącznik Z-G do taśm LED 10mm z gniazdem DC 5.5/2.1 żeński, 10 szt.

Z-G LED strip connector, 10mm with DC 5.5/2.1 female socket, 10 pcs.

Symbol Product no.	EAN	Zasilanie Power supply	Stopień ochrony Protection rating
AD-TL-6188/Z-G/10	5908254819063	12V DC	IP20



Roździelacz do taśm LED 1/2, zestaw 5 szt.

1/2 LED strip splitter, 5 pcs.

Symbol Product no.	EAN	Zasilanie Power supply	Stopień ochrony Protection rating
AD-TL-6188/R1-2/5	5908254819049	12V DC	IP20





Warianty produktu:

AVAILABLE VARIANTS



AD-OM-6207L4/W

AD-OM-6207L4



Materiał: stal lakierowana
Material: painted steel



Materiał: stal nierdzewna (INOX)
Material: stainless steel (INOX)



Rodzaj włącznika: bezdotykowy
Type of switch: touchless



Rodzaj włącznika: bezdotykowy
Type of switch: touchless

Symbol Product no.	EAN	Moc Rated power	Strumień świetlny Luminous flux	Źródło światła Light source	Temperatura barwowa Color temperature	Kolor Color	szer./wys./gł. [mm] W x H x D [mm]
AD-OM-6207L4/W	5908254823183	2,5W	180lm	LED SMD	4000K	biały white	80 / 120 / 50
AD-OM-6207L4	5908254818301	2,5W	180lm	LED SMD	4000K	inox	80 / 120 / 50



METU LED

Oprawa sieciowo-awaryjna

Mains -operated luminaire with emergency mode

Główne cechy / Main features

Stopień ochrony
Protection rating

IP65

Źródło światła: LED SMD
Light source: LED SMD



Podwójne źródło światła: 190lm/145lm
Double light source: 190lm/145lm



Czas pracy awaryjnej: 3 h
Emergency work time: 3 h



Symbol Product no.	EAN	Zasilanie Power supply	Moc Rated power	Strumień świetlny Luminous flux	Temperatura barwowa Color temperature	Stopień ochrony Protection rating	Materiał Material	szer./wys./gl. [mm] W x H x D [mm]
AD-OA-6197L6	5908254823176	230V~, 50Hz	2,7W	240lm (AC) 140lm (DC)	6000K	IP65	PC	349 / 107 / 64

electric line



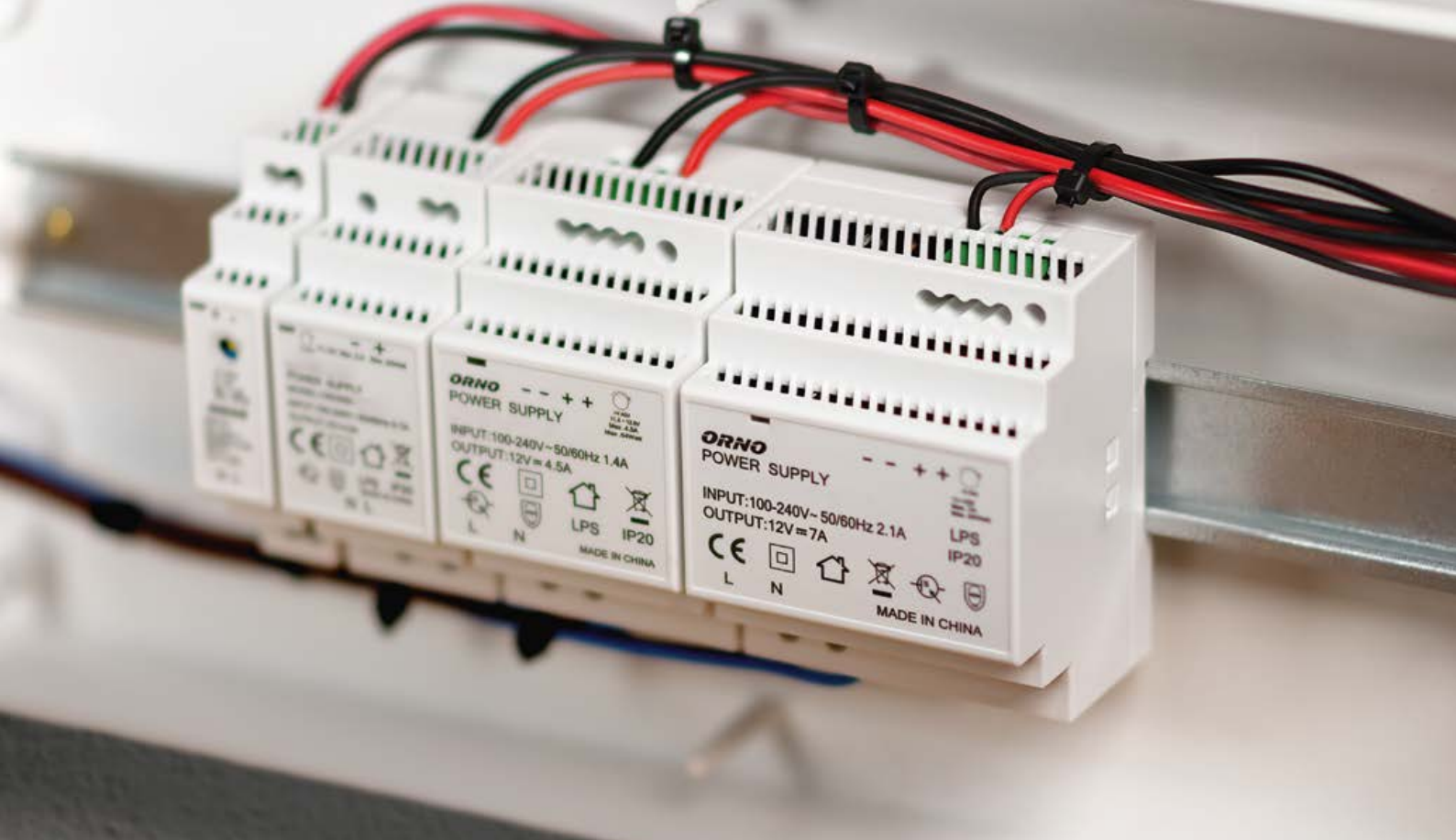

Aparatura modułowa

MODULAR DEVICES









Liczniki energii POWER METERS	172
Zasilacze POWER SUPPLY UNITS	174
Listwy zaciskowe BRASS BUSBAR	178
Bloki rozdzielcze DISTRIBUTION BLOCKS	180

LICZNIKI ENERGII

POWER METERS





Model Product no	OR-WE-502	OR-WE-503	OR-WE-504	OR-WE-507
EAN	5907565612288	5901752480315	5901752481282	5901752482340
Zgodność Conformity	×	×	×	×
Norma Standard	×	×	×	IEC62052-11, IEC62053-21
Napięcie znamionowe Rated voltage	230V~, 50Hz	230V~, 50Hz	230V~, 50Hz	3x230/400V, 50/60Hz
Prąd min. (I _{min}) Min. current	0,25A	0,25A	0,25A	0,25A
Prąd bazowy (I _b) Base current	5A	5A	5A	20A
Prąd maks. (I _{max}) Max. current	80A	80A	80A	120A
Klasa dokładności Accuracy class	1	1	1	1
Wyświetlacz LCD LCD	LCD 6+1 = 123456.1 kWh	LCD 5+1 = 12345.1 kW	LCD 5+1 = 12345.1 kW	LCD 6+1 = 123456.1 kWh
Temperatura robocza Working temperature	-20~45	-20~65	-20~45	-20~45
Zakres napięcia wyjścia impulsowego Pulse output voltage range	12-27VDC	12-27VDC	×	12-27VDC
Prąd wyjścia impulsowego Pulse output current	≤ 27mA	≤ 27mA	×	≤ 27mA
Stopień ochrony Protection level	IP20	IP20	IP20	IP20
Maks. przekrój przewodów przyłączeniowych Max. cross-section of cables	35 mm ²	35 mm ²	35 mm ²	35 mm ²
Montaż Installation	Na szynę DIN DIN rail TH-35	Na szynę DIN DIN rail TH-35	Na szynę DIN DIN rail TH-35	Na szynę DIN DIN rail TH-35
Szerokość Width	4,5 moduły / modules 78mm	2 moduły / modules 36mm	1,1 modułu /modules 19,5mm	5 modułów / modules 90mm
Stała licznika [imp/kWh] Meter constant [imp/kWh]	1600	1000	1000	1000
Wyjście impulsowe S0 Pulse output S0	✓	✓	×	✓
Port IR	×	×	×	×
Protokół RS485, Modbus-RTU Protocol RS485, Modbus-RTU	×	×	✓	×
Niebieskie podświetlenie Blue backlight	×	✓	×	✓
Moc czynna Active power	✓	✓	✓	✓
Moc bierna Reactive power	×	×	✓	×
Moc pobrana Forwarded power	✓	✓	✓	✓
Moc oddana Reversed power	×	×	×	×
Wielotaryfowość Multitariff	×	×	×	×

							
OR-WE-521	OR-WE-512	OR-WE-514	OR-WE-515	OR-WE-520	OR-WE-513	OR-WE-516	OR-WE-517
5908254801860	5902560322378	5902560322385	5902560322392	5900378653011	5902560322408	5902560322415	5902560322422
MID 2014/32/EU	MID 2014/32/EU	MID 2014/32/EU	MID 2014/32/EU	MID 2014/32/EU	MID 2014/32/EU	MID 2014/32/EU	MID 2014/32/EU
EN50470-1:2006, EN50470-3:2006	EN50470-1:2006, EN50470-3:2006	EN50470-1:2006, EN50470-3:2006	EN50470-1:2006, EN50470-3:2006	IEC62052-11, IEC62053-21, EN50470-1/3	IEC62052-11, IEC62053-21, EN50470-1/3	IEC62052-11, IEC62053-21, EN50470-1/3	IEC62052-11, IEC62053-21, EN50470-1/3
230V~, 50Hz	230V~, 50Hz	230V~, 50Hz	230V~, 50Hz	3x230/400V, 50Hz	3x230/400V, 50Hz	3x230/400V, 50Hz	3x230/400V, 50Hz
0,25A	0,25A	0,25A	0,25A	0,25A	0,25A	0,25A	0,25A
5A	5A	5A	5A	5A	5A	5A	5A
40A	100A	100A	100A	80A	80A	80A	80A
B	B	B	B	B	B	B	B
LCD 5+2 = 12345.12 kWh	LCD 5+1 = 12345,1 kWh	LCD 5+1 = 12345,1 kWh	LCD 5+1 = 12345,1 kWh	LCD 6+2 = 123456.12	LCD 6+2 = 123456.12	LCD 6+2 = 123456.12	LCD 6+2 = 123456.12
-25~55°C	-25~55°C	-25~55°C	-25~55°C	-25~55°C	-25~55°C	-25~55°C	-25~55°C
12-27VDC	✗	✗	✗	12-27VDC	12-27VDC	12-27VDC	12-27VDC
≤ 27mA	✗	✗	✗	≤ 27mA	≤ 27mA	≤ 27mA	≤ 27mA
IP51	IP51	IP51	IP51	IP51	IP51	IP51	IP51
6 mm ²	25 mm ²	25 mm ²	25 mm ²	35 mm ²	35 mm ²	35 mm ²	35 mm ²
Na szynę DIN DIN rail TH-35	Na szynę DIN DIN rail TH-35	Na szynę DIN DIN rail TH-35	Na szynę DIN DIN rail TH-35	Na szynę DIN DIN rail TH-35	Na szynę DIN DIN rail TH-35	Na szynę DIN DIN rail TH-35	Na szynę DIN DIN rail TH-35
1 moduł / module 18mm	1 moduł / module 18mm	1 moduł / module 18mm	1 moduł / module 18mm	4,3 moduły / modules 76,11mm	4,3 moduły / modules 76,11mm	4,3 moduły / modules 76,11mm	4,3 moduły / modules 76,11mm
1000	1000	1000	1000	800	1000	1000	1000
✓	✗	✗	✗	✓	✓	✓	✓
✓	✗	✗	✗	✓	✓	✓	✓
✗	✗	✓	✓	✗	✗	✓	✓
✓	✓	✓	✓	✓	✗	✗	✗
✓	✓	✓	✓	✓	✓	✓	✓
✗	✓	✓	✓	✗	✓	✓	✓
✓	✓	✓	✓	✓	✓	✓	✓
✗	✗	✗	✗	✗	✗	✓	✓
✗	✗	✗	✓	✗	✗	✗	✓

ZASILACZE

POWER SUPPLY UNITS

			
Model Product no	OR-PSU-1642	OR-PSU-1643	OR-PSU-1644
EAN	5908254803833	5908254803840	5908254803857
Napięcie wyjścia Output voltage	12V DC	12V DC	12V DC
Prąd wyjścia Output current	1,25A	2A	4,5A
Moc Power	15W	24W	54W
Maksymalny prąd chwilowy Max. instant current	2,1A	2,4A	5A
Napięcie wejścia Input voltage	100-230V 50-60Hz	100-230V 50-60Hz	100-230V 50-60Hz
Stopień ochrony Protection level	IP20	IP20	IP20
Montaż Installation	Na szynę DIN For DIN rail	Na szynę DIN For DIN rail	Na szynę DIN For DIN rail
Regulacja napięcia Voltage adjustment	tak	tak	tak
Zabezpieczenie przeciwzwarciowe Shortcircuit protection	tak	tak	tak
Zabezpieczenie prądowe Overload protection	tak	tak	tak
Zabezpieczenie napięciowe Voltage protection	tak	tak	tak
Pobór mocy w stanie spoczynku Standby power consumption	0,3W	0,3W	0,3W
Ilość modułów (18mm) Number of modules (18mm)	1	2	3
Wymiary (szer./wys./gl. [mm]) Dimensions (W/H/D [mm])	18 / 90 / 58	35 / 90 / 58	52,5 / 90 / 58

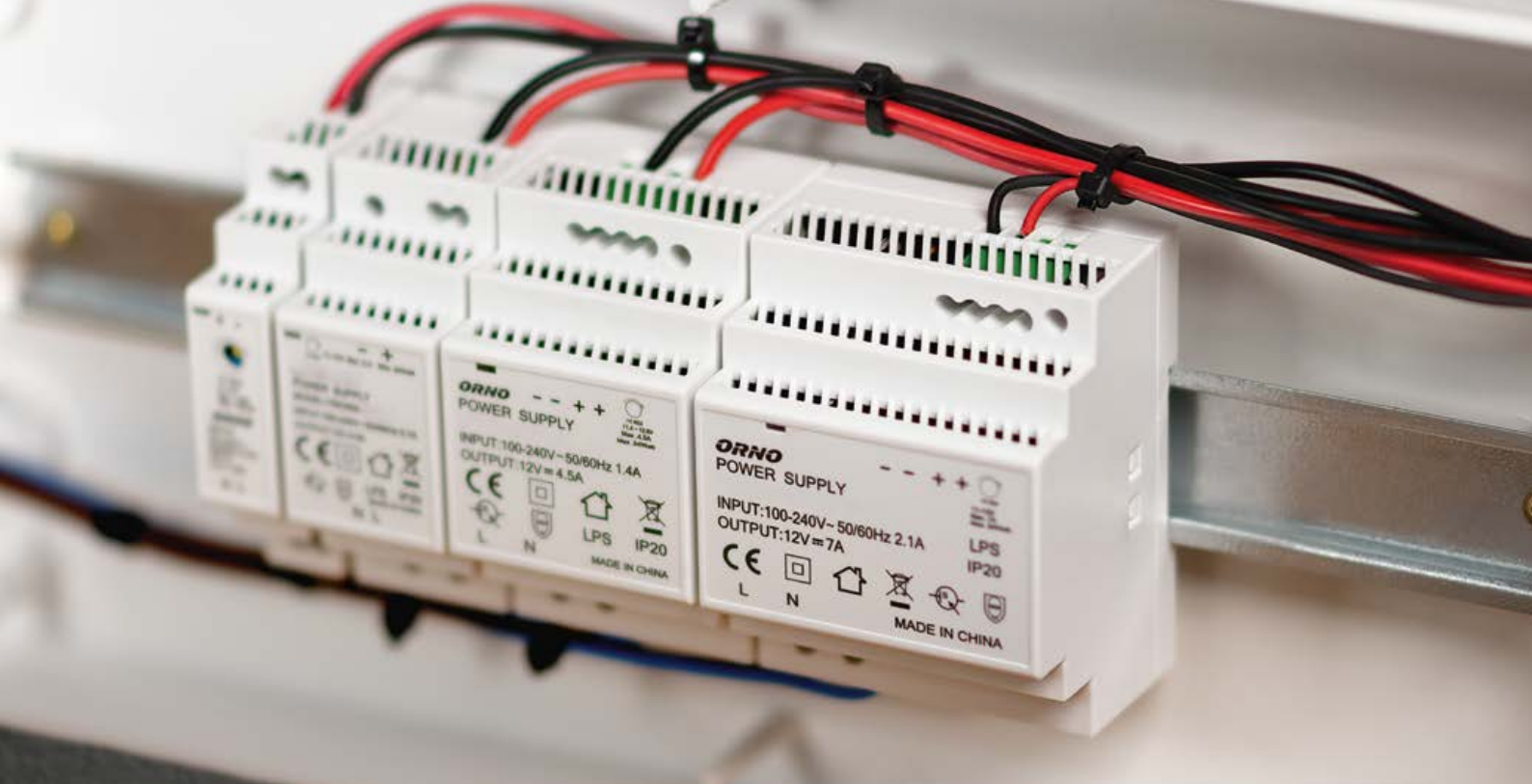

				
OR-PSU-1645	OR-PSU-1646	OR-PSU-1647	OR-PSU-1648	OR-PSU-1649
5908254803864	5908254803871	5908254803888	5908254803895	5908254803901
12V DC	24V DC	24V DC	24V DC	24V DC
7A	0,63A	1A	2,5A	4A
84W	15W	24W	60W	96W
9A	0,8A	1,25A	3,4A	4,6A
100-230V 50-60Hz	100-230V 50-60Hz	100-230V 50-60Hz	100-230V 50-60Hz	100-230V 50-60Hz
IP20	IP20	IP20	IP20	IP20
Na szynę DIN For DIN rail	Na szynę DIN For DIN rail	Na szynę DIN For DIN rail	Na szynę DIN For DIN rail	Na szynę DIN For DIN rail
tak	tak	tak	tak	tak
tak	tak	tak	tak	tak
tak	tak	tak	tak	tak
tak	tak	tak	tak	tak
0,3W	0,3W	0,3W	0,3W	0,3W
4	1	2	3	4
70 / 90 / 58	18 / 90 / 58	35 / 90 / 58	52,5 / 90 / 58	70 / 90 / 58

Elektroniczny programator czasowy

Weekly digital timer



Wbudowany akumulator
Built-in battery



Montaż na szynie DIN
DIN rail installation

Symbol Product no.	EAN	Zasilanie Power supply	Maks. obciążenie Max. load	Prąd Current	Ilość programów Number of programmes	Stopień ochrony Protection rating	Wymiary (szer./wys./gl. [mm]) Dimensions (W/H/D [mm])
OR-PRE-414	5901752483804	230V~, 50Hz	3600W	16A	16	IP20	33 / 82 / 66

Elektroniczny programator czasowy

Weekly digital timer



Wbudowany akumulator
Built-in battery



Montaż na szynie DIN
DIN rail installation



Intuicyjne menu
User friendly menu

Symbol Product no.	EAN	Zasilanie Power supply	Moc maks. Max. power	Prąd Current	Ilość programów Number of programmes	Stopień ochrony Protection rating	Wymiary (szer./wys./gl. [mm]) Dimensions (W/H/D [mm])
OR-PRE-433	5902560327410	230V~, 50Hz	3680W	16A	52	IP20	36 / 90 / 65

Automat schodowy, instalacja 3 lub 4 żyłowa

Staircase lighting timer, 3 or 4-wire installation



Montaż na szynie DIN
DIN rail installation

Symbol Product no.	EAN	Zasilanie Power supply	Maks. obciążenie Max. load	Prąd Current	Ilość programów Number of programmes	Stopień ochrony Protection rating	Wymiary (szer./wys./gl. [mm]) Dimensions (W/H/D [mm])
OR-CR-230	5901752483545	230V~, 50Hz	2300W	10A	—	IP20	17,5 / 80 / 66

Czujnik zmierzchowy z hermetyczną zewnętrzną sondą

Twilight sensor with external probe

Montaż na szynie DIN
DIN rail installation



Stopień ochrony: IP20 / IP65
Protection rating: IP20 / IP65



Symbol Product no.	EAN	Zasilanie Power supply	Maks. obciążenie Max. load	Zakres regulacji natężenia światła LUX Light intensity adjustment range (LUX)	Otwór montażowy sondy([mm]) Probe mounting hole ([mm])	Wym. przekaźnika (szer./wys./gł. [mm]) Relay dimensions (W/H/D [mm])
OR-CR-219	5901752482296	230V~, 50Hz	3000W	<2–100lux	Ø9,6	35 / 90 / 66

Czujnik zmierzchowy z hermetyczną zewnętrzną sondą

Twilight sensor with external probe

Autonomiczna sonda
Stand-alone probe



Montaż na szynie DIN
DIN rail installation







Stopień ochrony: IP20 / IP65
Protection rating: IP20 / IP65









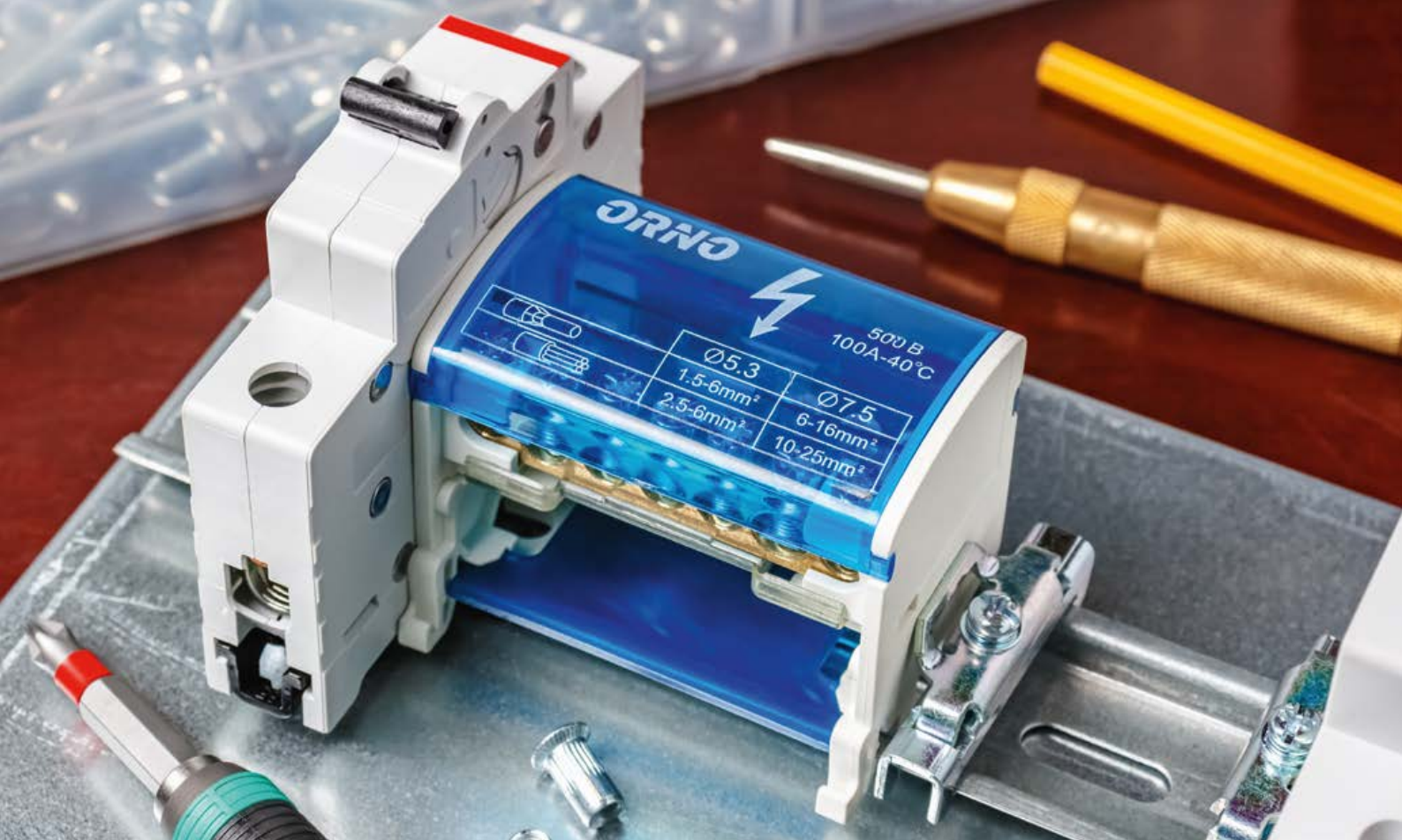

Symbol Product no.	EAN	Zasilanie Power supply	Maks. obciążenie Max. load	Zakres regulacji natężenia światła LUX Light intensity adjustment range (LUX)	Wymiary sondy (szer./wys./gł. [mm]) Dim. of the probe (W/H/D [mm])	Wym. przekaźnika (szer./wys./gł. [mm]) Relay dimensions (W/H/D [mm])
OR-CR-231	5901752483972	230V~, 50Hz	3000W	<2–100lux	42 / 48 / 30	35 / 90 / 66

LISTWY ZACISKOWE

BRASS BUSBAR

					
Model Product no	OR-LZ-8205/8	OR-LZ-8205/16	OR-LZ-8205/24	OR-LZ-8204/8/Y	OR-LZ-8204/12/Y
EAN	5908254809347	5908254809354	5908254809361	5908254809286	5908254809293
Typ Type	Listwa zaciskowa Brass busbar	Listwa zaciskowa Brass busbar	Listwa zaciskowa Brass busbar	Listwa zaciskowa PE Brass busbar PE	Listwa zaciskowa PE Brass busbar PE
Ilość przewodów Number of wires	8	16	24	8	12
Materiał styków Conductor material	Mosiądz Brass	Mosiądz Brass	Mosiądz Brass	Mosiądz Brass	Mosiądz Brass
Materiał obudowy Housing material	-	-	-	PoliAmid	PoliAmid
Klasa palności UL94 Fire rating UL94	-	-	-	V2	V2
Maksymalna średnica przewodu [mm] Max. wire cross section [mm]	4,5	4,5	4,5	4,5	4,5
Stopień ochrony Protection rating	IP00	IP00	IP00	IP00	IP00
Montaż Installation	Śrubowy Screw	Śrubowy Screw	Śrubowy Screw	Na szynę DIN For DIN rail	Na szynę DIN For DIN rail
Wymiary (szer./wys./gł. [mm]) Dimensions (w/h/d [mm])	57,6 / 9 / 6	102 / 9 / 6	159 / 9 / 6	56 / 43 / 11,5	81 / 43 / 11,5









							
OR-LZ-8204/18/Y	OR-LZ-8204/8/BL	OR-LZ-8204/12/BL	OR-LZ-8204/18/BL	OR-LZ-8203/8/BL	OR-LZ-8203/12/BL	OR-LZ-8203/8/GN	OR-LZ-8203/12/GN
5908254809309	5908254809316	5908254809323	5908254809330	5908254809255	5908254809262	5908254809224	5908254809231
Listwa zaciskowa PE Brass busbar PE	Listwa zaciskowa N Brass busbar N	Listwa zaciskowa N Brass busbar N	Listwa zaciskowa N Brass busbar N	Izolowana Listwa zaciskowa N Insulated brass busbar N	Izolowana Listwa zaciskowa N Insulated brass busbar N	Izolowana Listwa zaciskowa PE Insulated brass busbar PE	Izolowana Listwa zaciskowa PE Insulated brass busbar PE
18	8	12	18	8	12	8	12
Mosiądz Brass	Mosiądz Brass	Mosiądz Brass	Mosiądz Brass	Mosiądz Brass	Mosiądz Brass	Mosiądz Brass	Mosiądz Brass
PoliAmid	PoliAmid	PoliAmid	PoliAmid	PoliAmid	PoliAmid	PoliAmid	PoliAmid
V2	V2	V2	V2	V2	V2	V2	V2
4,5	4,5	4,5	4,5	4,8	4,8	4,8	4,8
IP00	IP00	IP00	IP00	IP20	IP20	IP20	IP20
Na szynę DIN For DIN rail	Na szynę DIN For DIN rail	Na szynę DIN For DIN rail	Na szynę DIN For DIN rail	Na szynę DIN / Na płytę montażową For DIN rail / Mounting plate	Na szynę DIN / Na płytę montażową For DIN rail / Mounting plate	Na szynę DIN / Na płytę montażową For DIN rail / Mounting plate	Na szynę DIN / Na płytę montażową For DIN rail / Mounting plate
118 / 43 / 11,5	56 / 43 / 11,5	81 / 43 / 11,5	118 / 43 / 11,5	78,5 / 35 / 11	102 / 35 / 11	78,5 / 35 / 11	102 / 35 / 11

BLOKI ROZDZIELCZE

DISTRIBUTION BLOCKS

						
Model Product no	OR-LZ-8201/7	OR-LZ-8201/11	OR-LZ-8201/15	OR-LZ-8202/7	OR-LZ-8202/11	OR-LZ-8202/15
EAN	5908254809163	5908254809170	5908254809187	5908254809194	5908254809200	5908254809217
Ilość szyn Number of busbars	2	2	2	4	4	4
Materiał obudowy Body material	PoliAmid	PoliAmid	PoliAmid	PoliAmid	PoliAmid	PoliAmid
Klasa palności UL94 Fire rating UL94	V2	V2	V2	V2	V2	V2
Materiał pokrywy Cover material	PC	PC	PC	PC	PC	PC
Materiał styków Conductor material	Mosiądz Brass	Mosiądz Brass	Mosiądz Brass	Mosiądz Brass	Mosiądz Brass	Mosiądz Brass
Ilość przewodów Number of wires	7	11	15	7	11	15
Zaciski wejściowe [mm²] Input screw terminals [mm ²]	5x 1,5-6, 2x 6-16	7x 1,5-6, 2x 6-16, 2x 10-16	11x 1,5-6, 2x 6-16, 2x 10-16	5x 1,5-6, 2x 6-16	7x 1,5-6, 2x 6-16, 2x 10-16	11x 1,5-6, 2x 6-16, 2x 10-16
Stopień ochrony Protection rating	IP20	IP20	IP20	IP20	IP20	IP20
Montaż Installation	Na szynę DIN / Na płytę montażową For DIN rail / Mounting plate	Na szynę DIN / Na płytę montażową For DIN rail / Mounting plate	Na szynę DIN / Na płytę montażową For DIN rail / Mounting plate	Na szynę DIN / Na płytę montażową For DIN rail / Mounting plate	Na szynę DIN / Na płytę montażową For DIN rail / Mounting plate	Na szynę DIN / Na płytę montażową For DIN rail / Mounting plate
Wymiary (szer./wys./gł. [mm]) Dimensions (w / h / d [mm])	65 / 42 / 50	100 / 42 / 50	135 / 42 / 50	65 / 85 / 50	100 / 85 / 50	135 / 85 / 50

						
Model Product no	OR-LZ-8200/80	OR-LZ-8200/125	OR-LZ-8200/160	OR-LZ-8200/250	OR-LZ-8200/400	OR-LZ-8200/500
EAN	5908254809101	5908254809118	5908254809125	5908254809132	5908254809149	5908254809156
Prąd [A] Current [A]	80	125	160	250	400	500
Materiał obudowy Body material	PoliAmid	PoliAmid	PoliAmid	PoliAmid	PoliAmid	PoliAmid
Klasa palności UL94 Fire rating UL94	V0	V0	V0	V0	V0	V0
Materiał pokrywy Cover material	PC	PC	PC	PC	PC	PC
Materiał styków Conductor material	Niklowany mosiądz Nickelated Brass	Niklowany mosiądz Nickelated Brass	Niklowany mosiądz Nickelated Brass	Niklowany mosiądz Nickelated Brass	Niklowany mosiądz Nickelated Brass	Niklowany mosiądz Nickelated Brass
Zaciski wejściowe [mm²] Input screw terminals [mm ²]	1x 6-16	1x 6-16; 1x 10-35	1x 6-16; 1x 10-70	1x 35-120	1x 95-185	Szyna (copper bar) 4x15,5x0,8 - 8x24x1
Zaciski wyjściowe [mm²] Output screw terminals [mm ²]	4x 2,5-6; 2x 2,5-16	6x 2,5-16	6x 2,5x16	2x 6-35; 5x 2,5-16; 4x 2,5-10	2x 6-35; 5x 2,5-16; 4x 2,5-10	Szyna (copper bar) 2x 6-35, 5x 2,5-16, 4x 2,5-10
Napięcie izolacji Ui wg. IEC [V] Ui acc. IEC [V]	1000	1000	1000	1000	1000	1000
Napięcie izolacji Ui wg. UL [V] Ui acc. UL [V]	600	600	600	600	600	600
Znamionowy prąd krótkotrwały wytrzymywany Icw [kA] Short time withstand current Icw [kA]	3	4,2	11,8	24,5	24,5	24,5
Szczytowy prąd zwarciový wytrzymywany Ipk [kA] Peak short circuit Current Ipk [kA]	22	30	30	51	51	51
Spełniane normy Standards	IEC 60998-1, IEC 60998-2-1, IEC 60947-7-1, IEC 60947-7-1, UL 1059, UL 486E, CSA22.2 158-1987, GB 13140.1, GB 13140.2	IEC 60998-1, IEC 60998-2-1, IEC 60947-7-1, IEC 60947-7-1, UL 1059, UL 486E, CSA22.2 158-1987, GB 13140.1, GB 13140.2	IEC 60998-1, IEC 60998-2-1, IEC 60947-7-1, IEC 60947-7-1, UL 1059, UL 486E, CSA22.2 158-1987, GB 13140.1, GB 13140.2	IEC 60998-1, IEC 60998-2-1, IEC 60947-7-1, IEC 60947-7-1, UL 1059, UL 486E, CSA22.2 158-1987, GB 13140.1, GB 13140.2	IEC 60998-1, IEC 60998-2-1, IEC 60947-7-1, IEC 60947-7-1, UL 1059, UL 486E, CSA22.2 158-1987, GB 13140.1, GB 13140.2	IEC 60998-1, IEC 60998-2-1, IEC 60947-7-1, IEC 60947-7-1, UL 1059, UL 486E, CSA22.2 158-1987, GB 13140.1, GB 13140.2
Stopień ochrony Protection rating	IP20	IP20	IP20	IP20	IP20	IP20
Montaż Installation	Na szynę DIN / Na płytę montażową For DIN rail / Mounting plate	Na szynę DIN / Na płytę montażową For DIN rail / Mounting plate	Na szynę DIN / Na płytę montażową For DIN rail / Mounting plate	Na szynę DIN / Na płytę montażową For DIN rail / Mounting plate	Na szynę DIN / Na płytę montażową For DIN rail / Mounting plate	Na szynę DIN / Na płytę montażową For DIN rail / Mounting plate
Rozstaw otworów montażowych [mm] Mounting screws set-up [mm]	54	64	64	85x29	85x29	85x29
Możliwość rozbudowy Possible expansion	yes	yes	yes	yes	yes	yes
Moment dokręcania śrub [Nm.] Torque [Nm.]	In: 3,5 Out: 1 ; 3,5	In: 3,5 ; 8,5 Out: 3,5	In: 3,5 ; 8,5 Out: 3,5	In: 19 Out: 4,4 ; 2,7 ; 2,7	In: 25 Out: 4,4 ; 2,7 ; 2,7	In: 10 Out: 4,4 ; 2,7 ; 2,7
Wymiary (szer./wys./gł. [mm]) Dimensions (w / h / d [mm])	30 / 65 / 46	29 / 77 / 46	29 / 77 / 46	49 / 96 / 50	49 / 96 / 50	49 / 96 / 50



Zasilacze

POWER SUPPLY UNITS

Zasilacze modułowe MODULAR POWER SUPPLY UNITS	184
Zasilacze open frame OPEN FRAME POWER SUPPLY UNITS	184
Zasilacze LED do puszki LED POWER SUPPLY UNITS, FLUSH-MOUNTED	185
Zasilacze do LED LED POWER SUPPLY UNITS	185

Zasilacze modułowe

Modular power supply units



OR-PSU-1641



OR-PSU-1653



OR-PSU-1654

Symbol Product no.	EAN	Napięcie wyjścia Output voltage	Prąd wyjścia Output current	Moc Rated power	Napięcie wejścia Input voltage	Wymiary (szer./wys./gł. [mm]) Dimensions (W/H/D [mm])
OR-PSU-1641	5908254803826	12V DC	1A	12W	100-240V~	95 / 85 / 32
OR-PSU-1653	5908254814174	13,5V DC	1.7A	20W	100-240V~	85 / 57 / 33
OR-PSU-1654	5908254814181	15V DC	1.6A	25W	100-240V~	80 / 42 / 28



Zasilacze open frame







Open frame power supply units



Regulacja napięcia
Voltage adjustment



Przebieżalność chwilowa 150%
Momentary overload 150%

Symbol Product no.	EAN	Napięcie wyjścia Output voltage	Prąd wyjścia Output current	Moc Rated power	Napięcie wejścia Input voltage	Wymiary (szer./wys./gł. [mm]) Dimensions (W/H/D [mm])
 OR-ZL-1631	5900378658719	12V DC	2A	24W	100-240V~	85 / 57 / 33
 OR-ZL-1632	5900378658726	12V DC	3A	36W	100-240V~	85 / 57 / 33
 OR-ZL-1633	5900378658733	12V DC	5A	60W	100-240V~	110 / 78 / 33
 OR-ZL-1634	5900378658740	12V DC	10A	120W	100-240V~	198 / 98 / 42
 OR-ZL-1635	5900378658757	12V DC	12,5A	150W	100-240V~	198 / 98 / 42
 OR-ZL-1636	5900378658764	12V DC	16,5A	200W	100-240V~	198 / 98 / 42
 OR-ZL-1637	5900378658771	12V DC	20,8A	250W	100-240V~	200 / 110 / 50

Zasilacze open frame

Open frame power supply units



Przebieżalność chwilowa 150%
Momentary overload 150%



Regulacja napięcia
Voltage adjustment



Symbol Product no.	EAN	Napięcie wyjścia Output voltage	Prąd wyjścia Output current	Moc Rated power	Napięcie wejścia Input voltage	Wymiary (szer./wys./gł. [mm]) Dimensions (W/H/D [mm])
OR-ZL-1638	5908254803345	12V DC	25A	300W	100-240V ~	200 / 100 / 50
OR-ZL-1639	5908254803352	12V DC	33A	400W	100-240V ~	215 / 112 / 50
OR-ZL-1640	5908254803369	12V DC	41A	500W	100-240V ~	215 / 112 / 50



Zasilacze LED do puszkki

LED power supply units, flush-mounted

Montaż dopuszkowy
Flush mounting

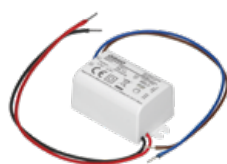

OR-ZL-1629

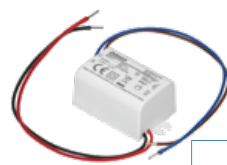

OR-ZL-1630

IP67



OR-ZL-1655

IP67

Symbol Product no.	EAN	Napięcie wyjścia Output voltage	Prąd wyjścia Output current	Moc Rated power	Napięcie wejścia Input voltage	Wymiary (szer./wys./gł. [mm]) Dimensions (W/H/D [mm])
OR-ZL-1629	5900378655428	12V DC	0.5A	6W	220-240V~	55 / 29.5 / 22
OR-ZL-1630	5900378655435	12V DC	0.5A	6W	220-240V~	55 / 29.5 / 22
OR-ZL-1655	5908254815546	12V DC	0.8A	10W	90-254V~	58 / 25 / 50

Zasilacze do LED

LED power supply units



Symbol Product no.	EAN	Napięcie wyjścia Output voltage	Prąd wyjścia Output current	Moc Rated power	Napięcie wejścia Input voltage	Wymiary (szer./wys./gł. [mm]) Dimensions (W/H/D [mm])
OR-ZL-1609	5901752486799	12V DC	0,5A	6W	90-254V~	73 / 22 / 33
OR-ZL-1610	5901752486805	12V DC	0,75A	9W	90-254V~	100 / 25 / 40
OR-ZL-1611	5901752486812	12V DC	1A	12W	90-254V~	100 / 25 / 40
OR-ZL-1612	5901752486829	12V DC	1,25A	15W	90-254V~	100 / 25 / 40
OR-ZL-1613	5901752486836	12V DC	1,5A	18W	90-254V~	120 / 28 / 42
OR-ZL-1614	5901752486843	12V DC	2A	24W	90-254V~	120 / 28 / 42
OR-ZL-1615	5901752486850	12V DC	2,5A	30W	90-254V~	120 / 28 / 42
OR-ZL-1616	5901752486867	12V DC	4,2A	50W	90-254V~	140 / 30 / 46





Zasilacz płaski do LED

Flat power adaptor for LED



SLIM DESIGN



OR-ZL-1629



OR-ZL-1629



OR-ZL-1629

Symbol Product no.	EAN	Napięcie wyjścia Output voltage	Prąd wyjścia Output current	Moc Rated power	Napięcie wejścia Input voltage	Stopień ochrony Protection rating	Wymiary (szer./wys./gl. [mm]) Dimensions (W/H/D [mm])
OR-ZL-1650	5908254803918	12V DC	1.25A	15W	220-240V~	IP20	103 / 35,5 / 16,5
OR-ZL-1651	5908254803925	12V DC	2.5A	30W	220-240V~	IP20	160 / 58 / 18
OR-ZL-1652	5908254803932	12V DC	5A	50W	220-240V~	IP20	160 / 58 / 18



IP67

Zasilacze do LED

LED power supply units



Symbol Product no.	EAN	Napięcie wyjścia Output voltage	Prąd wyjścia Output current	Moc Rated power	Napięcie wejścia Input voltage	Wymiary (szer./wys./gl. [mm]) Dimensions (W/H/D [mm])
OR-ZL-1602	5901752482746	12V DC	1A	12W	100-240V~	135 / 30 / 22
OR-ZL-1603	5901752482753	12V DC	1,6A	20W	100-240V~	180 / 31 / 22
OR-ZL-1604	5901752482760	12V DC	2,5A	30W	100-240V~	223 / 30 / 22
OR-ZL-1605	5901752482777	12V DC	4,2A	50W	100-240V~	190 / 50 / 35
OR-ZL-1606	5901752482784	12V DC	5,83A	70W	170-250V~	170 / 54 / 35
OR-ZL-1607	5901752482791	12V DC	8,5A	100W	170-250V~	185 / 70 / 45
OR-ZL-1608	5901752482807	12V DC	12,5A	150W	170-250V~	230 / 70 / 45



Osprzęt elektroinstalacyjny

ELECTRICAL INSTALLATION EQUIPMENT

Watomierze POWER METERS	191
Programatory czasowe TIMERS	192
Gniazda i wtyczki SOCKETS AND PLUGS	193
Przełączniki SWITCHES	194
Rozgałęźniki POWER SOCKET SPLITTERS	196
Gniazda i wtyczki warsztatowe WORKSHOP SOCKETS AND PLUGS	198
Rozgałęźniki bryzgoszczelne HEAVY-DUTY EXTENSION SOCKETS	200
Gniazda i wtyczki przyczepy TRAILER PLUGS AND SOCKETS	201
Inne MISCELLANEOUS	202



Watomierze

POWER METERS







OR-WAT-435
OR-WAT-435(GS)



OR-WAT-419
OR-WAT-419(GS)



Wbudowany akumulator
Built-in battery

Symbol Product no.	EAN	Zasilanie Power supply	Maks. obciążenie Max. load	Prąd Current	Stopień ochrony Protection rating	Standard gniazd Standard of the socket	Wymiary (szer./wys./gl. [mm]) Dimensions (W/H/D [mm])
OR-WAT-419	5902560320169	230V~, 50Hz	3680W	16A	IP20	 french (E type)	63 / 107 / 75
OR-WAT-419(GS)	5902560324525	230V~, 50Hz	3680W	16A	IP20	 Schuko (F type)	63 / 107 / 75
OR-WAT-435	5902560328493	230V~, 50Hz	3680W	16A	IP20	 french (E type)	70 / 149 / 77,2
OR-WAT-435(GS)	5902560329384	230V~, 50Hz	3680W	16A	IP20	 Schuko (F type)	70 / 149 / 77,2

Programatory czasowe

TIMERS

mechaniczne
MECHANICAL



OR-PRE-427
OR-PRE-427(GS)



OR-PRE-443
OR-PRE-443(GS)



OR-PRE-445(GS)



OR-PRE-446(GS)



elektroniczne
ELECTRONIC



OR-PRE-409
OR-PRE-409(GS)



OR-PRE-432



Symbol Product no.	EAN	Zasilanie Power supply	Maks. obciążenie Max. load	Prąd Current	Wbudowany akumulator Built-in battery	Ilość programów Number of programmes	Standard gniazd Standard of the socket	Wymiary (szer./wys./gł. [mm]) Dimensions (W/H/D [mm])
OR-PRE-427	5902560323061	230V~, 50Hz	3500W	16A	✗		french (typ E)	60 / 96 / 67
OR-PRE-427(GS)	5902560323085	230V~, 50Hz	3500W	16A	✗		Schuko (typ F)	60 / 96 / 67
OR-PRE-443	5900378654704	230V~, 50Hz	3680W	16A	✗		french (typ E)	73 / 126 / 79
OR-PRE-443(GS)	5908254812217	230V~, 50Hz	3680W	16A	✗		Schuko (typ F)	73 / 126 / 79
OR-PRE-445(GS)	5908254811517	230V~, 50Hz	3680W	16A	✗	6	Schuko (typ F)	56 / 111 / 83
OR-PRE-446(GS)	5908254811531	230V~, 50Hz	3680W	16A	✗	6	Schuko (typ F)	56 / 111 / 83
OR-PRE-409	5901752483132	230V~, 50Hz	3680W	16A	✓	16	french (typ E)	55 / 115 / 75
OR-PRE-409(GS)	5902560320725	230V~, 50Hz	3680W	16A	✓	16	Schuko (typ F)	55 / 115 / 75
OR-PRE-432	5902560327021	230V~, 50Hz	3600W	16A	✓	8	french (typ E)	65 / 139 / 88,5

Gniazda i wtyczki

SOCKETS AND PLUGS



OR-AE-1374
OR-AE-1374/B



OR-AE-13182
OR-AE-13182/B



OR-AE-1379/W
OR-AE-1379/B



Ergonomiczny uchwyt
Ergonomic grip



Płaska wtyczka
Flat plug



OR-AE-13183
OR-AE-13183/B



OR-AE-1311/W
OR-AE-1311/B
OR-AE-1312/W
OR-AE-1312/B



Ergonomiczny uchwyt
Ergonomic grip



Płaska wtyczka
Flat plug

Symbol Product no.	EAN	Typ wtyczki Type of plug	Prąd Current	Standard wtyczki Standard of the plug	Wtyczka kątowa Angular plug	Rodzaj połączenia Type of connection	Uziemienie Grounding	Przewód Wire	Kolor Color
OR-AE-1374	5901752489202	2P/II	2,5A	euro	✗	śrubowe screw	✗	—	biały white
OR-AE-1374/B	5901752489202	2P/II	2,5A	euro	✗	śrubowe screw	✗	—	czarny black
OR-AE-13182	5908254801853	2P+Z 2P+E	16A	Uni-Schuko (typ E/F)	✓	śrubowe screw	✓	—	biały white
OR-AE-13182/B	5908254814068	2P+Z 2P+E	16A	Uni-Schuko (typ E/F)	✓	śrubowe screw	✓	—	czarny black
OR-AE-1379/W	5901752489615	2P+Z 2P+E	16A	Uni-Schuko (typ E/F)	✓	śrubowe screw	✓	—	biały white
OR-AE-1379/B	5901752489622	2P+Z 2P+E	16A	Uni-Schuko (typ E/F)	✓	śrubowe screw	✓	—	czarny black
OR-AE-1311/W	5901752484344	2P+Z 2P+E	16A	Uni-Schuko (typ E/F)	✓	śrubowe screw	✓	—	biały white
OR-AE-1311/B	5901752484351	2P+Z 2P+E	16A	Uni-Schuko (typ E/F)	✓	śrubowe screw	✓	—	czarny black
OR-AE-1312/W	5901752484368	2P+Z 2P+E	16A	Uni-Schuko (typ E/F)	✓	—	✓	1,5m	biały white
OR-AE-1312/B	5901752484375	2P+Z 2P+E	16A	Uni-Schuko (typ E/F)	✓	—	✓	1,5m	czarny black
OR-AE-13183	5908254801945	2P+Z 2P+E	16A	french (typ E)	✗	śrubowe screw	✓	—	biały white
OR-AE-13183/B	5908254814075	2P+Z 2P+E	16A	french (typ E)	✗	śrubowe screw	✓	—	czarny black

Łączniki kołyskowe

ROCKER SWITCHES



OR-AE-13180/W
OR-AE-13180/B
OR-AE-13180/G



OR-AE-13179/W
OR-AE-13179/B

Symbol Product no.	EAN	Zasilanie Power supply	Ilość przewodów Number of wires	Kolor Color	Wymiary (szer./wys./gl. [mm]) Dimensions (W/H/D [mm])	Otwór montażowy Mounting hole
OR-AE-13180/W	5908254801877	230V~, 50Hz	1	biały white	Ø23 / 25	Ø20mm
OR-AE-13180/B	5908254801884	230V~, 50Hz	1	czarny black	Ø23 / 25	Ø20mm
OR-AE-13180/G	5908254801891	230V~, 50Hz	1	szary grey	Ø23 / 25	Ø20mm
OR-AE-13179/W	5908254801907	230V~, 50Hz	2	biały white	21,5 / 28,5 / 30	21 / 31mm
OR-AE-13179/B	5908254801914	230V~, 50Hz	2	czarny black	21,5 / 28,5 / 30	21 / 31mm

Wyłącznik pociągany

PULL SWITCH



OR-AE-13224



OR-AE-1326

Symbol Product no.	EAN	Zasilanie Power supply	Prąd Current	Materiał Material	Kolor Color
OR-AE-13224	5908254819025	230V~, 50Hz	2,5A	tworzywo sztuczne plastic	biały white
OR-AE-1326	5901752486591	230V~, 50Hz	3A	tworzywo sztuczne plastic	biały white

Przewody zasilające z wyłącznikiem i płaską wtyczką

POWER CORDS WITH SWITCH AND EURO PLUG



OR-AE-1394/W
OR-AE-1394/B



OR-AE-1395/W

Symbol Product no.	EAN	Zasilanie Power supply	Prąd Current	Przekrój żyły Wire cross-section	Długość przewodu Length of the wire	Materiał Material	Kolor Color
OR-AE-1394/W	5902560323030	230V~, 50Hz	2,5A	2x0,75mm ²	3m	tworzywo sztuczne plastic	biały white
OR-AE-1394/B	5902560323047	230V~, 50Hz	2,5A	2x0,75mm ²	3m	tworzywo sztuczne plastic	czarny black
OR-AE-1395/W	5902560323054	230V~, 50Hz	2,5A	2x0,75mm ²	2m	tworzywo sztuczne plastic	biały white

Ściemniacze z płynną regulacją

DIMMERS WITH SMOOTH LIGHT ADJUSTMENT



OR-AE-1393/W
OR-AE-1393/B



OR-AE-13115



OR-AE-13114
OR-AE-13114(GS)

Symbol Product no.	EAN	Zasilanie Power supply	Max. obciążenie Max. load	Przekrój żyły Wire cross-section	Kolor Color	Wymiary (szer./wys./gt. [mm]) Dimensions (W/H/D [mm])
OR-AE-1393/W	5902560323023	230V~, 50Hz	80W	2x0,75mm ²	biały white	70 / 35 / 32
OR-AE-1393/B	5902560323016	230V~, 50Hz	80W	2x0,75mm ²	czarny black	70 / 35 / 32
OR-AE-13115	5902560323351	230V~, 50Hz	100W	2x1mm ²	biały white	55 / 95 / 45
OR-AE-13114	5902560323337	230V~, 50Hz	280W	-	biały white	55 / 94 / 73
OR-AE-13114(GS)	5908254812880	230V~, 50Hz	280W	-	biały white	55 / 94 / 73

Rozgałęźniki

POWER SOCKET SPLITTERS



OR-AE-13178
OR-AE-13178(GS)



OR-AE-13134/T



OR-AE-13134/L



OR-AE-13134/G



OR-AE-13134/P



OR-AE-13221



OR-AE-13221/B



OR-AE-13184
OR-AE-13184(GS)



OR-AE-13184/B
OR-AE-13184(GS)/B



OR-AE-1377



OR-AE-1378



Obrotowe gniazdo
Rotary plug



Przycisk ON/OFF
ON/OFF switch



OR-AE-13188
OR-AE-13188(GS)



Przycisk ON/OFF
ON/OFF switch



OR-AE-13187
OR-AE-13187(GS)



Przycisk ON/OFF
ON/OFF switch



OR-AE-13191
OR-AE-13191(GS)



Przycisk ON/OFF
ON/OFF switch

Symbol Product no.	EAN	Prąd Current	Standard gniazd Standard of the socket	Ilość gniazd sieciowych Number of sockets	Kolor Color
OR-AE-13178	5908254801952	16A	french (typ E)	3 x 2P+Z 3 x 2P+E	biały white
OR-AE-13178(GS)	5908254813399	16A	Schuko (typ F)	3 x 2P+Z 3 x 2P+E	biały white
OR-AE-13134/T	5902560329636	16A	french (typ E)	3 x 2P+Z 3 x 2P+E	turkusowy turquoise
OR-AE-13134/L	5902560329643	16A	french (typ E)	3 x 2P+Z 3 x 2P+E	limonkowy lime
OR-AE-13134/G	5902560329650	16A	french (typ E)	3 x 2P+Z 3 x 2P+E	szary grey
OR-AE-13134/P	5902560329667	16A	french (typ E)	3 x 2P+Z 3 x 2P+E	różowy pink
OR-AE-13221	5908254813375	16A	french (typ E)	2 x 2P+Z/ 1 x 2P 2 x 2P+E/ 1 x 2P	biały white
OR-AE-13221/B	5908254813382	16A	french (typ E)	2 x 2P+Z/ 1 x 2P 2 x 2P+E/ 1 x 2P	czarny black
OR-AE-13184	5908254801969	16A	french (typ E)	3 x 2P+Z 3 x 2P+E	biały white
OR-AE-13184(GS)	5908254813320	16A	Schuko (typ F)	3 x 2P+Z 3 x 2P+E	biały white
OR-AE-13184/B	5908254813313	16A	french (typ E)	3 x 2P+Z 3 x 2P+E	czarny black
OR-AE-13184(GS)/B	5908254813337	16A	Schuko (typ F)	3 x 2P+Z 3 x 2P+E	czarny black
OR-AE-1378	5901752489608	16A	french (typ E)	3 x 2P+Z 3 x 2P+E	biały white
OR-AE-13188	5908254801976	16A	french (typ E)	1 x 2P+Z 1 x 2P+E	biały white
OR-AE-13188(GS)	5908254813351	16A	Schuko (typ F)	1 x 2P+Z 1 x 2P+E	biały white
OR-AE-13187	5908254801983	16A	french (typ E)	2 x 2P+Z 2 x 2P+E	biały white
OR-AE-13187(GS)	5908254813344	16A	Schuko (typ F)	2 x 2P+Z 2 x 2P+E	biały white
OR-AE-13191	5908254803284	16A	french (typ E) / euro	1 x 2P+Z/ 2 x 2P 1 x 2P+E/ 2 x 2P	biały white
OR-AE-13191(GS)	5908254813368	16A	Schuko (typ F) / euro	1 x 2P+Z/ 2 x 2P 1 x 2P+E/ 2 x 2P	biały white
OR-AE-1377	5901752489592	16A	french (typ E) / euro	2 x 2P+Z/ 1 x 2P 2 x 2P+E/ 1 x 2P	biało-szary grey-white

Gniazda i wtyczki warsztatowe

WORKSHOP SOCKETS AND PLUGS



OR-AE-1315

OR-AE-13222
OR-AE-13222/25

OR-AE-1369

OR-AE-1314
OR-AE-1314(GS)OR-AE-13223(GS)
OR-AE-13223(GS)/25OR-AE-1370
OR-AE-1370(GS)

Symbol Product no.	EAN	Prąd Current	Typ gniazda Type of socket	Standard gniazda Standard of the socket	Ilość gniazd sieciowych Number of sockets	Rodzaj połączenia Type of connection	Materiał Material	Kolor Color
OR-AE-13222	5908254813405	16A	2P+Z 2P+E	Uni-Schuko (typ E/F)	1	śrubowe screw	guma rubber	czarny black
OR-AE-13222/25	5908254814501	16A	2P+Z 2P+E	Uni-Schuko (typ E/F)	1	śrubowe screw	guma rubber	czarny black
OR-AE-1315	5901752484429	16A	2P+Z 2P+E	Uni-Schuko (typ E/F)	1	śrubowe screw	guma rubber	czarny black
OR-AE-1369	5901752488342	16A	2P+Z 2P+E	Uni-Schuko (typ E/F)	1	śrubowe screw	guma rubber	czarny black
OR-AE-1314	5901752484412	16A	2P+Z 2P+E	french (typ E)	1	śrubowe screw	guma rubber	czarny black
OR-AE-1314(GS)	5900378650553	16A	2P+Z 2P+E	Schuko (typ F)	1	śrubowe screw	guma rubber	czarny black
OR-AE-1370	5901752488359	16A	2P+Z 2P+E	french (typ E)	1	śrubowe screw	guma rubber	czarny black
OR-AE-1370(GS)	5908254812682	16A	2P+Z 2P+E	Schuko (typ F)	1	śrubowe screw	guma rubber	czarny black
OR-AE-13223(GS)	5908254813412	16A	2P+Z 2P+E	Schuko (typ F)	1	śrubowe screw	guma rubber	czarny black
OR-AE-13223(GS)/25	5908254814518	16A	2P+Z 2P+E	Schuko (typ F)	1	śrubowe screw	guma rubber	czarny black



OR-AE-13117
OR-AE-13117(GS)



OR-AE-13237



OR-AE-1346
OR-AE-1346(GS)



OR-AE-13209



Symbol Product no.	EAN	Prąd Current	Typ gniazda Type of socket	Standard gniazda Standard of the socket	Ilość gniazd sieciowych Number of sockets	Rodzaj połączenia Type of connection	Materiał Material	Kolor Color
OR-AE-13117	5902560325669	16A	2P+Z 2P+E	french (typ E)	2	śrubowe screw	guma rubber	czarny black
OR-AE-13117(GS)	5902560325683	16A	2P+Z 2P+E	Schuko (typ F)	2	śrubowe screw	guma rubber	czarny black
OR-AE-13237	5908254821394	16A	2P+Z 2P+E	french (typ E)	4	śrubowe screw	tworzywo sztuczne plastic	czarny black
OR-AE-13237(GS)	5908254821417	16A	2P+Z 2P+E	Schuko (typ F)	4	śrubowe screw	tworzywo sztuczne plastic	czarny black
OR-AE-13209	5908254809040	16A	2P+Z 2P+E	french (typ E)	3	śrubowe screw	guma rubber	czarny black
OR-AE-13209(GS)	5908254809057	16A	2P+Z 2P+E	Schuko (typ F)	3	śrubowe screw	guma rubber	czarny black
OR-AE-1346	5901752487499	16A	2P+Z 2P+E	french (typ E)	3	śrubowe screw	tworzywo sztuczne plastic	czarny black
OR-AE-1346(GS)	5902560326970	16A	2P+Z 2P+E	Schuko (typ F)	3	śrubowe screw	tworzywo sztuczne plastic	czarny black



Rozgałęźniki bryzgoszczelne odporne na uderzenia

Heavy-duty extension sockets, rubber



Główne cechy / Main features

Wandaloodporne
Vandal proof



Materiał: guma
Material: rubber











Uniepalnione
Flame-retardant



Stopień ochrony: IP44
Protection rating: IP44



Symbol Product no.	EAN	Prąd Current	Ilość gniazd sieciowych Number of sockets	Typ gniazda Type of socket	Standard gniazd Standard of the socket	Kolor Color
OR-AE-13164	5900378658795	16A	1	2P+Z 2P+E	 french (typ E)	czarny black
OR-AE-13164(GS)	5900378658832	16A	1	2P+Z 2P+E	 Schuko (typ F)	czarny black
OR-AE-13165	5900378658801	16A	2	2P+Z 2P+E	 french (typ E)	czarny black
OR-AE-13165(GS)	5900378658849	16A	2	2P+Z 2P+E	 Schuko (typ F)	czarny black
OR-AE-13166	5900378658818	16A	3	2P+Z 2P+E	 french (typ E)	czarny black
OR-AE-13166(GS)	5900378658856	16A	3	2P+Z 2P+E	 Schuko (typ F)	czarny black
OR-AE-13167	5900378658825	16A	4	2P+Z 2P+E	 french (typ E)	czarny black
OR-AE-13167(GS)	5900378658863	16A	4	2P+Z 2P+E	 Schuko (typ F)	czarny black



Zestaw testowy gniazda przyczepy

Trailer socket tester

Symbol Product no.	EAN	Zasilanie Power supply	Ilość przewodów Number of wires	Materiał Material	Kolor Color	Wymiary (szer./wys./gł. [mm]) Dimensions (W x H x D [mm])
OR-AE-13231	5908254814587	12/24V	7/13	PA	czarny black	54,5 / 43 / 196,5



OR-AE-1384



OR-AE-1385



OR-AE-1386



OR-AE-1387



OR-AE-13229



OR-AE-13228



OR-AE-13230

Symbol Product no.	EAN	Zasilanie Power supply	Ilość przewodów Number of wires	Materiał Material	Kolor Color	Wymiary (szer./wys./gł. [mm]) Dimensions (W x H x D [mm])
OR-AE-1384	5901752489882	12/24V	7	PA	czarny black	50 / 100 / 40
OR-AE-1385	5901752489899	12/24V	7	aluminium	srebrny silver	50 / 95 / 40
OR-AE-1386	5901752489905	12/24V	7	PA	czarny black	75 / 72 / 50
OR-AE-1387	5901752489912	12/24V	7	aluminium	srebrny silver	70 / 70 / 52
OR-AE-13229	5908254814563	12/24V	13/7	PA	czarny black	44,9 / 63,6 / 51,8
OR-AE-13228	5908254814556	12/24V	13	PA	czarny black	48,5 / 58,2 / 118,4
OR-AE-13230	5908254814570	12/24V	13	PA	czarny black	62,4 / 72 / 50,7

Ładowarki USB

USB CHARGERS



OR-AE-13140
OR-AE-13140(GS)



OR-AE-13232
OR-AE-13232(GS)

Symbol Product no.	EAN	Zasilanie Power supply	Maks. obciążenie Max. load	Standard gniazd Standard of the socket	Ilość USB Number of USB	Ładowarka USB USB charger	Złącza Connectors	Wymiary (szer./wys./gł. [mm]) Dimensions (W/H/D [mm])
OR-AE-13140	5900378650607	230V~, 50Hz	3680W	french (typ E)	2	5VDC / 2,1A	2 x USB-A	80 / 80 / 41
OR-AE-13140(GS)	5900378653813	230V~, 50Hz	3680W	Schuko (typ F)	2	5VDC / 2,1A	2 x USB-A	80 / 80 / 41
OR-AE-13232	5908254816475	230V~, 50Hz	3680W	french (typ E)	2	5VDC / 2,8A	USB-A + USB-C	80 / 80 / 41
OR-AE-13232(GS)	5908254816482	230V~, 50Hz	3680W	Schuko (typ F)	2	5VDC / 2,8A	USB-A + USB-C	80 / 80 / 41



OR-AE-13151/W



OR-AE-13151/P



OR-AE-13151/BG

Ośłony ściany

WALL PLATES

Symbol Product no.	EAN	Kolor Color	Montaż Installation	Otwór Hole	Materiał Material	Wymiary (szer./wys./gł. [mm]) Dimensions (W/H/D [mm])
OR-AE-13151/W	5900378655374	biały white	natynkowy surface mounted	Ø70 mm	tworzywo sztuczne plastic	130 / 130 / 2
OR-AE-13151/P	5900378655398	przeźroczysty transparent	natynkowy surface mounted	Ø70 mm	tworzywo sztuczne plastic	130 / 130 / 2
OR-AE-13151/BG	5900378655381	beżowy beige	natynkowy surface mounted	Ø70 mm	tworzywo sztuczne plastic	130 / 130 / 2



Przedłużacze

EXTENSION CORDS

Przedłużacze domowe HOME EXTENSION SOCKETS	206
Przedłużacze bębnowe, domowe HOME CABLE REELS	212
Przedłużacze ogrodowe GARDEN EXTENSION CORDS	213
Przedłużacze warsztatowe WORKSHOP EXTENSION SOCKETS	217
Przedłużacze bębnowe, warsztatowe WORKSHOP CABLE REELS	220

Przedłużacze domowe

HOME EXTENSION SOCKETS

Zasilanie: 230V~, 50Hz
Power supply: 230V~, 50Hz



Płaska wtyczka
Flat plug



OR-AE-13195



OR-AE-13194
OR-AE-13194(GS)



OR-AE-13145/W
ORAE13145(GS)/W



OR-AE-13145/B
ORAE13145(GS)/B



OR-AE-13146/W
ORAE13146(GS)/W



OR-AE-13146/B
ORAE13146(GS)/B



OR-AE-13149/W
ORAE13149(GS)/W



OR-AE-13149/B
ORAE13149(GS)/B



OR-AE-13150/W
ORAE13150(GS)/W



OR-AE-13150/B

Symbol Product no.	EAN	Maks. obciążenie Max. load	Prąd Current	Ilość gniazd Number of sockets	Typ gniazda Type of socket	Standard gniazd Standard of the socket	Typ izolacji Type of insulation	Przekrój żyły Wire cross-section	Długość przewodu Length of the wire	Wyłącznik Switch	Kolor Color
OR-AE-13195/1,5M	5908254805356	500W	2,5A	1	2P	euro (typ C)	PVC	0,75 mm ²	1,5m	<input type="radio"/>	<input type="checkbox"/>
OR-AE-13195/3M	5908254805363	500W	2,5A	1	2P	euro (typ C)	PVC	0,75 mm ²	5m	<input type="radio"/>	<input type="checkbox"/>
OR-AE-13195/5M	5908254805370	500W	2,5A	1	2P	euro (typ C)	PVC	0,75 mm ²	3m	<input type="radio"/>	<input type="checkbox"/>
OR-AE-13194/1,5M	5908254805233	3680W	16A	1	2P+Z 2P+E	french (typ E)	PVC	1,5 mm ²	1,5m	<input type="radio"/>	<input type="checkbox"/>
OR-AE-13194/3M	5908254805240	3680W	16A	1	2P+Z 2P+E	french (typ E)	PVC	1,5 mm ²	3m	<input type="radio"/>	<input type="checkbox"/>
OR-AE-13194/5M	5908254805257	3680W	16A	1	2P+Z 2P+E	french (typ E)	PVC	1,5 mm ²	5m	<input type="radio"/>	<input type="checkbox"/>

Symbol Product no.	EAN	Maks. obciążenie Max. load	Prąd Current	Ilość gniazd Number of sockets	Typ gniazda Type of socket	Standard gniazd Standard of the socket	Typ izolacji Type of insulation	Przekrój żyły Wire cross-section	Długość przewodu Length of the wire	Wyłącznik Switch	Kolor Color
OR-AE-13145/W/1,5M	5900378655107	2300W	10A	3	2P+Z 2P+E	french (typ E)	PVC	1,0 mm ²	1,5m	○	□
OR-AE-13145/W/3M	5900378655114	2300W	10A	3	2P+Z 2P+E	french (typ E)	PVC	1,0 mm ²	3m	○	□
OR-AE-13145/W/5M	5900378655121	2300W	10A	3	2P+Z 2P+E	french (typ E)	PVC	1,0 mm ²	5m	○	□
OR-AE-13145/B/1,5M	5908254805295	2300W	10A	3	2P+Z 2P+E	french (typ E)	PVC	1,0 mm ²	1,5m	○	■
OR-AE-13145/B/3M	5908254805301	2300W	10A	3	2P+Z 2P+E	french (typ E)	PVC	1,0 mm ²	3m	○	■
OR-AE-13146/W/1,5M	5900378655138	2300W	10A	3	2P+Z 2P+E	french (typ E)	PVC	1,0 mm ²	1,5m	●	□
OR-AE-13146/W/3M	5900378655145	2300W	10A	3	2P+Z 2P+E	french (typ E)	PVC	1,0 mm ²	3m	●	□
OR-AE-13146/W/5M	5900378655152	2300W	10A	3	2P+Z 2P+E	french (typ E)	PVC	1,0 mm ²	5m	●	□
OR-AE-13146/B/1,5M	5908254805318	2300W	10A	3	2P+Z 2P+E	french (typ E)	PVC	1,0 mm ²	1,5m	●	■
OR-AE-13146/B/3M	5908254805325	2300W	10A	3	2P+Z 2P+E	french (typ E)	PVC	1,0 mm ²	3m	●	■
OR-AE-13149/W/1,5M	5900378655169	2300W	10A	5	2P+Z 2P+E	french (typ E)	PVC	1,0 mm ²	1,5m	○	□
OR-AE-13149/W/3M	5900378655176	2300W	10A	5	2P+Z 2P+E	french (typ E)	PVC	1,0 mm ²	3m	○	□
OR-AE-13149/W/5M	5900378655183	2300W	10A	5	2P+Z 2P+E	french (typ E)	PVC	1,0 mm ²	5m	○	□
OR-AE-13149/B/3M	5908254805332	2300W	10A	5	2P+Z 2P+E	french (typ E)	PVC	1,0 mm ²	3m	○	■
OR-AE-13150/W/1,5M	5900378655190	2300W	10A	5	2P+Z 2P+E	french (typ E)	PVC	1,0 mm ²	1,5m	●	□
OR-AE-13150/W/3M	5900378655206	2300W	10A	5	2P+Z 2P+E	french (typ E)	PVC	1,0 mm ²	3m	●	□
OR-AE-13150/W/5M	5900378655213	2300W	10A	5	2P+Z 2P+E	french (typ E)	PVC	1,0 mm ²	5m	●	□
OR-AE-13150/B/3M	5908254805349	2300W	10A	5	2P+Z 2P+E	french (typ E)	PVC	1,0 mm ²	3m	●	■
OR-AE-13194(GS)/1,5M	5908254805264	3680W	16A	1	2P+Z 2P+E	Schuko (typ F)	PVC	1,5 mm ²	1,5m	○	□
OR-AE-13194(GS)/3M	5908254805271	3680W	16A	1	2P+Z 2P+E	Schuko (typ F)	PVC	1,5 mm ²	3m	○	□
OR-AE-13194(GS)/5M	5908254805288	3680W	16A	1	2P+Z 2P+E	Schuko (typ F)	PVC	1,5 mm ²	5m	○	□
ORAE13145(GS)/W/1,5M	5900378654001	2300W	10A	3	2P+Z 2P+E	Schuko (typ F)	PVC	1,0 mm ²	1,5m	○	□
ORAE13145(GS)/W/3M	5900378659983	2300W	10A	3	2P+Z 2P+E	Schuko (typ F)	PVC	1,0 mm ²	3m	○	□
ORAE13145(GS)/W/5M	5900378659990	2300W	10A	3	2P+Z 2P+E	Schuko (typ F)	PVC	1,0 mm ²	5m	○	□
ORAE13145(GS)/B/1,5M	5908254811272	2300W	10A	3	2P+Z 2P+E	Schuko (typ F)	PVC	1,0 mm ²	1,5m	○	■
ORAE13145(GS)/B/3M	5908254811289	2300W	10A	3	2P+Z 2P+E	Schuko (typ F)	PVC	1,0 mm ²	3m	○	■
ORAE13146(GS)/W/1,5M	5908254800009	2300W	10A	3	2P+Z 2P+E	Schuko (typ F)	PVC	1,0 mm ²	1,5m	●	□
ORAE13146(GS)/W/3M	5908254800016	2300W	10A	3	2P+Z 2P+E	Schuko (typ F)	PVC	1,0 mm ²	3m	●	□
ORAE13146(GS)/W/5M	5908254800023	2300W	10A	3	2P+Z 2P+E	Schuko (typ F)	PVC	1,0 mm ²	5m	●	□
ORAE13146(GS)/B/1,5M	5908254811296	2300W	10A	3	2P+Z 2P+E	Schuko (typ F)	PVC	1,0 mm ²	1,5m	●	■
ORAE13146(GS)/B/3M	5908254811302	2300W	10A	3	2P+Z 2P+E	Schuko (typ F)	PVC	1,0 mm ²	3m	●	■
ORAE13149(GS)/W/1,5M	5908254800030	2300W	10A	5	2P+Z 2P+E	french (typ E)	PVC	1,0 mm ²	1,5m	○	□
ORAE13149(GS)/W/3M	5908254800047	2300W	10A	5	2P+Z 2P+E	Schuko (typ F)	PVC	1,0 mm ²	3m	○	□
ORAE13149(GS)/W/5M	5908254800054	2300W	10A	5	2P+Z 2P+E	Schuko (typ F)	PVC	1,0 mm ²	5m	○	□
ORAE13149(GS)/B/3M	5908254811319	2300W	10A	5	2P+Z 2P+E	Schuko (typ F)	PVC	1,0 mm ²	3m	○	■
ORAE13150(GS)/W/1,5M	5908254800061	2300W	10A	5	2P+Z 2P+E	Schuko (typ F)	PVC	1,0 mm ²	1,5m	●	□
ORAE13150(GS)/W/3M	5908254800078	2300W	10A	5	2P+Z 2P+E	Schuko (typ F)	PVC	1,0 mm ²	3m	●	□
ORAE13150(GS)/W/5M	5908254800085	2300W	10A	5	2P+Z 2P+E	Schuko (typ F)	PVC	1,0 mm ²	5m	●	□



Listwa przeciwprzebieciowa

POWER STRIP WITH SURGE PROTECTION

Główne cechy / Main features

System EasyEject
EasyEject



Ochronnik przeciwprzebieciowy Typ 3
Surge protection Type 3



Płaska wtyczka
Flat plug



Ładowarka USB-A + USB-C
USB-A + USB-C charger



Przycisk ON/OFF
ON/OFF switch



Symbol Product no.	EAN	Zasilanie Power supply	Maks. obciążenie Max. load	Ilość gniazd Number of sockets	Standard gniazd Standard of the socket	Typ izolacji Type of insulation	Przekrój żyły Wire cross-section	Długość przewodu Length of the wire
OR-AE-13234/W/1,5M	5908254820755	230V~, 50Hz	3680W	5	french (typ E)	PVC	1,5 mm ²	1,5m



Listwa zasilająca MultiSwitch

MULTISWITCH POWER STRIP



Wyłącznik główny dwutorowy
Two-way main switch



Osobne włączniki dla każdego gniazda
Separate switch for every socket



Ilość gniazd
Number of sockets



Wyłącznik termiczny
Overload protection

Symbol Product no.	EAN	Zasilanie Power supply	Maks. obciążenie Max. load	Standard gniazd Standard of the socket	Typ izolacji Type of insulation	Przekrój żyły Wire cross-section	Długość przewodu Length of the wire	Kolor Color
OR-AE-13162/1,5M	5900378655725	230V~, 50Hz	2300W	french (typ E)	PVC	1,0 mm ²	1,5m	biały white
OR-AE-13162/B/1,5M	5908254810961	230V~, 50Hz	2300W	french (typ E)	PVC	1,0 mm ²	1,5m	czarny black
ORAE13162(GS)/1,5M	5900378655732	230V~, 50Hz	3680W	Schuko (typ F)	PVC	1,5 mm ²	1,5m	biały white
ORAE13162(GS)/B/1,5M	5908254810978	230V~, 50Hz	3680W	Schuko (typ F)	PVC	1,5 mm ²	1,5m	czarny black

Listwa zasilająca nabiurkowa

DESKTOP POWER STRIP



Ochronnik przeciwprzepięciowy Typ 3
Surge protection Type 3



Ładowarka 2xUSB 2.4A
2xUSB 2.4A charger



Przysaski
Suction cups



Symbol Product no.	EAN	Zasilanie Power supply	Maks. obciążenie Max. load	Ilość gniazd Number of sockets	Standard gniazd Standard of the socket	Typ izolacji Type of insulation	Przekrój żyły Wire cross-section	Długość przewodu Length of the wire
OR-AE-13190/B	5908254802737	230V~, 50Hz	3680W	3	french (typ E)	PVC	1,5 mm ²	1,4m
OR-AE-13190(GS)/B	5908254802744	230V~, 50Hz	3680W	3	Schuko (typ F)	PVC	1,5 mm ²	1,4m



Listwa przeciwprzebieciowa

POWER STRIP WITH SURGE PROTECTION

Główne cechy / Main features

Ochronnik przeciwprzebieciowy Typ 3
Surge protection Type 3



Ładowarka 2xUSB 2.1A
2xUSB 2.1A charger



Przycisk ON/OFF
ON/OFF switch



OR-AE-13163/3M
OR-AE-13163(GS)/3M

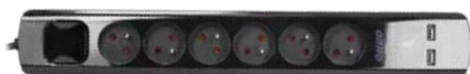

OR-AE-13163/B/3M
OR-AE-13163(GS)/B/3M

Symbol Product no.	EAN	Zasilanie Power supply	Maks. obciążenie Max. load	Ilość gniazd Number of sockets	Standard gniazd Standard of the socket	Typ izolacji Type of insulation	Przekrój żyły Wire cross-section	Długość przewodu Length of the wire
OR-AE-13163/3M	5900378655749	230V~, 50Hz	2300W	6	french (typ E)	PVC	1,0 mm ²	3m
ORAE13163(GS)/3M	5900378655756	230V~, 50Hz	3680W	6	Schuko (typ F)	PVC	1,5 mm ²	3m
OR-AE-13163/B/3M	5908254810985	230V~, 50Hz	2300W	6	french (typ E)	PVC	1,0 mm ²	3m
ORAE13163(GS)/B/3M	5908254810992	230V~, 50Hz	3680W	6	Schuko (typ F)	PVC	1,5 mm ²	3m



Przedłużacz 4-krotny z ładowarką USB

4 Extension sockets with USB charger

Nowoczesny przedłużacz sieciowy z innowacyjnym systemem mocującym, który umożliwi montaż na płaszczyznach poziomych i pionowych w trudno dostępnych miejscach np. do ściany lub pod powierzchnią blatu. Urządzenie posiada cztery gniazda sieciowe z uziemieniem i przesłonami torów prądowych, ładowarkę do wszelkiego typu telefonów, smartfonów, tableatów i innych urządzeń ładowanych przez port USB oraz przewód o długości 1,4m.

Modern extension sockets with an innovative fastening system that allows mounting in horizontal and vertical positions in hard-to-reach places, for instance: to the wall or under the worktop surface. The device has four power sockets with grounding and safety shutters, and a charger for all types of phones, smartphones, tablets and other devices charged via USB port. The cable is 1.4m long.



OR-AE-13144/W
ORAE13144(GS)/W



OR-AE-13144
ORAE13144(GS)



OR-AE-13144/L
ORAE13144(GS)/L

Symbol Product no.	EAN	Ilość gniazd sieciowych Number of sockets	Wersja french French type	Wersja Schuko Schuko type	Ładowarka USB USB charger	Kabel zasilający Power cable	szer./wys./gt. [mm] width/height/depth [mm]
OR-AE-13144/W	5908254816376	4 x 2P+Z 4 X 2P+E (max. 2300 W)	●	○	2 x USB 5V DC / 2,1A	1,4m (3x1,0mm ²)	77 / 77 / 77
OR-AE-13144(GS)/W	5908254816352	4 x 2P+Z 4 X 2P+E (max. 3680 W)	○	●	2 x USB 5V DC / 2,1A	1,4m (3x1,5mm ²)	77 / 77 / 77
OR-AE-13144	5900378654643	4 x 2P+Z 4 X 2P+E (max. 2300 W)	●	○	2 x USB 5V DC / 2,1A	1,4m (3x1,0mm ²)	77 / 77 / 77
OR-AE-13144(GS)	5908254803260	4 x 2P+Z 4 X 2P+E (max. 3680 W)	○	●	2 x USB 5V DC / 2,1A	1,4m (3x1,5mm ²)	77 / 77 / 77
OR-AE-13144/L	5908254812859	4 x 2P+Z 4 X 2P+E (max. 2300 W)	●	○	2 x USB 5V DC / 2,1A	1,4m (3x1,0mm ²)	77 / 77 / 77
OR-AE-13144(GS)/L	5908254812866	4 x 2P+Z 4 X 2P+E (max. 3680 W)	○	●	2 x USB 5V DC / 2,1A	1,4m (3x1,5mm ²)	77 / 77 / 77

Przedłużacze bębnowe domowe

HOME CABLE REELS



OR-AE-13113/G
OR-AE-13113(GS)/G



OR-AE-1339/G
OR-AE-1339/G(GS)



OR-AE-1339/T
OR-AE-1339/T(GS)



OR-AE-1339/L
OR-AE-1339/L(GS)



Symbol Product no	EAN	Standard gniazd Standard of the socket	Max. obciążenie / prąd przewód zwinięty Max. load / current coiled wire	Max. obciążenie / prąd przewód rozwinęty Max. load / current loose wire	Ilość gniazd sieciowych Number of sockets	Rodzaj przewodu Type of cable	Długość przewodu Length of the wire	Kolor Color
OR-AE-13113/G	5908254803604	french (typ E)	900W / 4A	2300W / 10A	4 x 2P+Z 4 x 2P+E	H05VV-F 3 x 1,0 mm ²	10m	szary grey
OR-AE-1339/G	5901752487390	french (typ E)	900W / 4A	2300W / 10A	4 x 2P+Z 4 x 2P+E	H05VV-F 3 x 1,0 mm ²	15 m	szary grey
OR-AE-1339/T	5901752487406	french (typ E)	900W / 4A	2300W / 10A	4 x 2P+Z 4 x 2P+E	H05VV-F 3 x 1,0 mm ²	15m	turkusowy turquoise
OR-AE-1339/L	5901752487383	french (typ E)	900W / 4A	2300W / 10A	4 x 2P+Z 4 x 2P+E	H05VV-F 3 x 1,0 mm ²	15m	limonkowy lime
OR-AE-13113(GS)/G	5908254803611	Schuko (typ F)	900W / 4A	2300W / 10A	4 x 2P+Z 4 x 2P+E	H05VV-F 3 x 1,0 mm ²	10m	szary grey
OR-AE-1339/G(GS)	5902560324402	Schuko (typ F)	900W / 4A	2300W / 10A	4 x 2P+Z 4 x 2P+E	H05VV-F 3 x 1,0 mm ²	15m	szary grey
OR-AE-1339/T(GS)	5902560325270	Schuko (typ F)	900W / 4A	2300W / 10A	4 x 2P+Z 4 x 2P+E	H05VV-F 3 x 1,0 mm ²	15m	turkusowy turquoise
OR-AE-1339/L(GS)	5902560325263	Schuko (typ F)	900W / 4A	2300W / 10A	4 x 2P+Z 4 x 2P+E	H05VV-F 3 x 1,0 mm ²	15m	limonkowy lime

PRZEDŁUŻACZE OGRODOWE

GARDEN EXTENSION CORDS



Gniazdo ogrodowe

GARDEN PLUG-IN SOCKETS

Główne cechy / Main features

Odporne na warunki pogodowe: IP44
Weatherproof: IP44



Materiał: tworzywo sztuczne PP
Material: plastic PP



Wymiary (szer./wys./gł. [mm]):
140 / 395 / 70

Dimensions (W/H/D [mm]):
140 / 395 / 70



Grot montażowy
Mounting spike



Kabel olejoodporny
Oil proof cable



Symbol Product no.	EAN	Standard gniazdo Standard of the socket	Napięcie zasilania Power supply	Max. obciążenie Max. load	Prąd Current	Ilość gniazd Number of sockets	Rodzaj kabla Type of cable	Długość kabla Length of the wire
OR-AE-13138	5900378650447	french (typ E)	230V~, 50Hz	3680W	16A	2 x 2P+Z 2 x 2P+E	H07RN-F	1,5m
OR-AE-13138(GS)	5900378659945	Schuko (typ F)	230V~, 50Hz	3680W	16A	2 x 2P+Z 2 x 2P+E	H07RN-F	1,5m



Gniazdo ogrodowe KAMIEN

Garden Socket STONE

Główne cechy / Main features



Odporne na warunki pogodowe: IP44
Weatherproof: IP44



Tryby pracy: auto / manual
Operating modes: auto / manual



Grot montażowy
Mounting spike



Realistyczny wygląd
Realistic look



Maks. obciążenie:
1100W (auto), 3680W (manual)
Max. load:
1100W (auto), 3680W (manual)



Kabel olejoodporny
Oil proof cable



Materiał: tworzywo sztuczne PP
Material: plastic PP



Wymiary (szer./wys./gt. [mm]):
460 / 460 / 200
Dimensions (W/H/D [mm]):
460 / 460 / 200

Symbol Product no.	EAN	Standard gniazd Standard of the socket	Napięcie zasilania Power supply	Maks. prąd Max. current	Ilość gniazd Number of sockets	Rodzaj kabla Type of cable	Długość kabla Length of the wire
OR-AE-13185	5908254801662	french (typ E)	230V~, 50Hz	16A	4 x 2P+Z 4 x 2P+E	H07RN-F	3m
OR-AE-13185(GS)	5908254801686	Schuko (typ F)	230V~, 50Hz	16A	4 x 2P+Z 4 x 2P+E	H07RN-F	3m



Gniazdo ogrodowe SŁUPEK

Garden Socket POST

Główne cechy / Main features

Odporne na warunki pogodowe: IP44
Weatherproof: IP44



Realistyczny wygląd
Realistic look



Materiał: żywica
Material: resin



Kabel olejoodporny
Oil proof cable



Wymiary (szer./wys./gl. [mm]):
460 / 460 / 200

Dimensions (W/H/D [mm]):
460 / 460 / 200



Symbol Product no.	EAN	Standard gniazd Standard of the socket	Napięcie zasilania Power supply	Max. obciążenie Max. load	Prąd Current	Ilość gniazd Number of sockets	Rodzaj kabla Type of cable	Długość kabla Length of the wire
OR-AE-13186	5908254801679	french (typ E)	230V~, 50Hz	3680W	16A	4 x 2P+Z 4 x 2P+E	H07RN-F	3m
OR-AE-13186(GS)	5908254801693	Schuko (typ F)	230V~, 50Hz	3680W	16A	4 x 2P+Z 4 x 2P+E	H07RN-F	3m

Przedłużacze ogrodowe

GARDEN EXTENSION CORD

Stopień ochrony: IP20
Protection rating: IP20Typ izolacji: PVC
Type of insulation: PVC

OR-AE-13210



OR-AE-13211(GS)



OR-AE-13212(GS)

Symbol Product no.	EAN	Standard gniazd Standard of the socket	Napięcie zasilania Power supply	Maks. obciążenie Max. load	Prąd Current	Typ gniazda Type of socket	Przekrój żyły Wire cross section	Długość przewodu Length of the wire
OR-AE-13210/10M	5908254812934	french (typ E)	230V~, 50Hz	2000W	10A	2P	2 x 1,0 mm ²	10m
OR-AE-13210/20M	5908254812941	french (typ E)	230V~, 50Hz	2000W	10A	2P	2 x 1,0 mm ²	20m
OR-AE-13210/30M	5908254812958	french (typ E)	230V~, 50Hz	2000W	10A	2P	2 x 1,0 mm ²	30m
OR-AE-13210/40M	5908254812965	french (typ E)	230V~, 50Hz	2000W	10A	2P	2 x 1,0 mm ²	40m
OR-AE-13210/50M	5908254812972	french (typ E)	230V~, 50Hz	2000W	10A	2P	2 x 1,0 mm ²	50m
OR-AE-13211(GS)/10M	5908254812989	Schuko (typ F)	230V~, 50Hz	2000W	10A	2P+Z 2P+E	3 x 1,0 mm ²	10m
OR-AE-13211(GS)/20M	5908254812996	Schuko (typ F)	230V~, 50Hz	2000W	10A	2P+Z 2P+E	3 x 1,0 mm ²	20m
OR-AE-13211(GS)/30M	5908254813009	Schuko (typ F)	230V~, 50Hz	2000W	10A	2P+Z 2P+E	3 x 1,0 mm ²	30m
OR-AE-13211(GS)/40M	5908254813016	Schuko (typ F)	230V~, 50Hz	2000W	10A	2P+Z 2P+E	3 x 1,0 mm ²	40m
OR-AE-13211(GS)/50M	5908254813023	Schuko (typ F)	230V~, 50Hz	2000W	10A	2P+Z 2P+E	3 x 1,0 mm ²	50m
OR-AE-13212(GS)/15M	5908254813030	Schuko (typ F)	230V~, 50Hz	3680W	16A	2P+Z 2P+E	3 x 1,5 mm ²	15m
OR-AE-13212(GS)/25M	5908254813047	Schuko (typ F)	230V~, 50Hz	3680W	16A	2P+Z 2P+E	3 x 1,5 mm ²	25m
OR-AE-13212(GS)/30M	5908254813054	Schuko (typ F)	230V~, 50Hz	3680W	16A	2P+Z 2P+E	3 x 1,5 mm ²	30m
OR-AE-13212(GS)/40M	5908254813061	Schuko (typ F)	230V~, 50Hz	3680W	16A	2P+Z 2P+E	3 x 1,5 mm ²	40m
OR-AE-13212(GS)/50M	5908254813078	Schuko (typ F)	230V~, 50Hz	3680W	16A	2P+Z 2P+E	3 x 1,5 mm ²	50m

Akcesoria dedykowane do przedłużaczy ogrodowych
Accessories dedicated to garden extension cordsHermetyczna puszka IP44
Hermetic cable box IP44OR-AE-13139
5900378650119Nawijak
Garden cord winderOR-AE-13161
5900378655541



Przedłużacz warsztatowy bryzgoszczelny

SPLASH-PROOF EXTENSION SOCKETS



Główne cechy / Main features

Maks. prąd: 230V~/16A
Max. current: 230V~/16A



Maks. obciążenie: 3680W
Max. load: 3680W



Odporne na warunki pogodowe: IP44
Weatherproof: IP44



Typ izolacji: guma
Type of insulation: rubber



Symbol Product no.	EAN	Standard gniazd Standard of the socket	Ilość gniazd sieciowych Number of sockets	Rodzaj przewodu Type of cable	Długość przewodu Length of the wire
OR-AE-13160/5M	5900378655527	french (typ E)	4	H05RR-F 3 x 1,5 mm ²	5m
OR-AE-13160/10M	5900378655534	french (typ E)	4	H05RR-F 3 x 1,5 mm ²	10m
OR-AE-13160(GS)/5M	5908254800115	Schuko (typ F)	4	H05RR-F 3 x 1,5 mm ²	5m
OR-AE-13160(GS)/10M	5908254800122	Schuko (typ F)	4	H05RR-F 3 x 1,5 mm ²	10m

Przedłużacze warsztatowe

WORKSHOP EXTENSION SOCKETS

Maks. prąd: 230V~/16A
Max. current: 230V~/16A



Maks. obciążenie: 3680W
Max. load: 3680W



Odporne na warunki pogodowe: IP44
Weatherproof: IP44



Typ izolacji: guma
Type of insulation: rubber



Zawieszka
Hanger



OR-AE-13169/10M
OR-AE-13169/20M
OR-AE-13169/30M



OR-AE-13169(GS)/10M
OR-AE-13169(GS)/20M
OR-AE-13169(GS)/30M



OR-AE-13158/3M
OR-AE-13158/5M



OR-AE-13192/3M
OR-AE-13192/5M



OR-AE-13193/3M
OR-AE-13193/5M



OR-AE-13159/3M
OR-AE-13159/5M



OR-AE-13158(GS)/3M
OR-AE-13158(GS)/5M



OR-AE-13192(GS)/3M
OR-AE-13192(GS)/5M



OR-AE-13193(GS)/3M
OR-AE-13193(GS)/5M



OR-AE-13159(GS)/3M
OR-AE-13159(GS)/5M

Symbol Product no.	EAN	Standard gniazd Standard of the socket	Ilość gniazd sieciowych Number of sockets	Rodzaj przewodu Type of cable	Długość przewodu Length of the wire	Wyłącznik Switch	Olejoodporność Oil proof
OR-AE-13169/10m	5900378659365	french (typ E)	1 x 2P+Z 1 x 2P+E	H07RN-F 3 x 1,5 mm ²	10m	○	●
OR-AE-13169/20m	5900378659372	french (typ E)	1 x 2P+Z 1 x 2P+E	H07RN-F 3 x 1,5 mm ²	20m	○	●
OR-AE-13169/30m	5900378659389	french (typ E)	1 x 2P+Z 1 x 2P+E	H07RN-F 3 x 1,5 mm ²	30m	○	●
OR-AE-13158/3M	5900378655503	french (typ E)	3 x 2P+Z 3 x 2P+E	H05RR-F 3 x 1,5 mm ²	3m	○	○
OR-AE-13158/5M	5908254804144	french (typ E)	3 x 2P+Z 3 x 2P+E	H05RR-F 3 x 1,5 mm ²	5m	○	○
OR-AE-13192/3M	5908254804151	french (typ E)	3 x 2P+Z 3 x 2P+E	H05RR-F 3 x 1,5 mm ²	3m	●	○
OR-AE-13192/5M	5908254804168	french (typ E)	3 x 2P+Z 3 x 2P+E	H05RR-F 3 x 1,5 mm ²	5m	●	○
OR-AE-13193/3M	5908254804175	french (typ E)	5 x 2P+Z 5 x 2P+E	H05RR-F 3 x 1,5 mm ²	3m	○	○
OR-AE-13193/5M	5908254804182	french (typ E)	5 x 2P+Z 5 x 2P+E	H05RR-F 3 x 1,5 mm ²	5m	○	○
OR-AE-13159/3M	5908254804199	french (typ E)	5 x 2P+Z 5 x 2P+E	H05RR-F 3 x 1,5 mm ²	3m	●	○
OR-AE-13159/5M	5900378655510	french (typ E)	5 x 2P+Z 5 x 2P+E	H05RR-F 3 x 1,5 mm ²	5m	●	○
OR-AE-13169(GS)/10M	5908254800542	Schuko (typ F)	1 x 2P+Z 1 x 2P+E	H07RN-F 3 x 1,5 mm ²	10m	○	●
OR-AE-13169(GS)/20M	5908254800559	Schuko (typ F)	1 x 2P+Z 1 x 2P+E	H07RN-F 3 x 1,5 mm ²	20m	○	●
OR-AE-13169(GS)/30M	5908254800566	Schuko (typ F)	1 x 2P+Z 1 x 2P+E	H07RN-F 3 x 1,5 mm ²	30m	○	●
OR-AE-13158(GS)/3M	5908254800092	Schuko (typ F)	3 x 2P+Z 3 x 2P+E	H05RR-F 3 x 1,5 mm ²	3m	○	○
OR-AE-13158(GS)/5M	5908254804205	Schuko (typ F)	3 x 2P+Z 3 x 2P+E	H05RR-F 3 x 1,5 mm ²	5m	○	○
OR-AE-13192(GS)/3M	5908254804212	Schuko (typ F)	3 x 2P+Z 3 x 2P+E	H05RR-F 3 x 1,5 mm ²	3m	●	○
OR-AE-13192(GS)/5M	5908254804229	Schuko (typ F)	3 x 2P+Z 3 x 2P+E	H05RR-F 3 x 1,5 mm ²	5m	●	○
OR-AE-13193(GS)/3M	5908254804236	Schuko (typ F)	5 x 2P+Z 5 x 2P+E	H05RR-F 3 x 1,5 mm ²	3m	○	○
OR-AE-13193(GS)/5M	5908254804243	Schuko (typ F)	5 x 2P+Z 5 x 2P+E	H05RR-F 3 x 1,5 mm ²	5m	○	○
OR-AE-13159(GS)/3M	5908254804298	Schuko (typ F)	5 x 2P+Z 5 x 2P+E	H05RR-F 3 x 1,5 mm ²	3m	●	○
OR-AE-13159(GS)/5M	5908254800108	Schuko (typ F)	5 x 2P+Z 5 x 2P+E	H05RR-F 3 x 1,5 mm ²	5m	●	○

Przedłużacze bębnowe warsztatowe

WORKSHOP CABLE REELS

Stopień ochrony: IP20
Protection rating: IP20



Typ izolacji: PVC
Type of insulation: PVC



OR-AE-13170(GS)



OR-AE-13171(GS)



OR-AE-13152
OR-AE-13152(GS)



OR-AE-13153
OR-AE-13153(GS)



OR-AE-13154
OR-AE-13154(GS)

Symbol Product no.	EAN	Standard gniazd Standard of the socket	Max. obciążenie / prąd przewód zwinięty Max. load / current coiled wire	Max. obciążenie / prąd przewód rozwinięty Max. load / current loose wire	Ilość gniazd sieciowych Number of sockets	Rodzaj przewodu Type of cable	Długość przewodu Length of the wire	Stale gniazda Fixed sockets
OR-AE-13152/30M	5900378655671	french (typ E)	900W / 3,9A	2300W / 10A	4 x 2P+Z 4 x 2P+E	H05VV-F 3 x 1,0 mm ²	30m	○
OR-AE-13153/30M	5900378655688	french (typ E)	1000W / 4,35A	3000W / 13,9A	4 x 2P+Z 4 x 2P+E	H05VV-F 3 x 1,5 mm ²	30m	○
OR-AE-13153/50M	5900378655695	french (typ E)	1000W / 4,35A	3000W / 13,9A	4 x 2P+Z 4 x 2P+E	H05VV-F 3 x 1,5 mm ²	50m	○
OR-AE-13154/25M	5900378655466	french (typ E)	1100W / 4,8A	3200W / 13,9A	4 x 2P+Z 4 x 2P+E	H05VV-F 3 x 1,5 mm ²	25m	●
OR-AE-13155/50M	5900378655473	french (typ E)	1100W / 4,8A	3200W / 13,9A	4 x 2P+Z 4 x 2P+E	H05VV-F 3 x 1,5 mm ²	50m	●
OR-AE-13170(GS)/15M	5908254800139	Schuko (typ F)	900W / 3,9A	2300W / 10A	4 x 2P+Z 4 x 2P+E	H05VV-F 3 x 1,0 mm ²	15m	○
OR-AE-13171(GS)/15M	5908254800146	Schuko (typ F)	1000W / 4,4A	3200W / 13,9A	4 x 2P+Z 4 x 2P+E	H05VV-F 3 x 1,5 mm ²	15m	○
OR-AE-13152(GS)/30M	5908254800153	Schuko (typ F)	900W / 3,9A	2300W / 10A	4 x 2P+Z 4 x 2P+E	H05VV-F 3 x 1,0 mm ²	30m	○
OR-AE-13153(GS)/30M	5908254800160	Schuko (typ F)	1000W / 4,4A	3200W / 13,9A	4 x 2P+Z 4 x 2P+E	H05VV-F 3 x 1,5 mm ²	30m	○
OR-AE-13153(GS)/50M	5908254800177	Schuko (typ F)	1000W / 4,4A	3200W / 13,9A	4 x 2P+Z 4 x 2P+E	H05VV-F 3 x 1,5 mm ²	50m	○
OR-AE-13154(GS)/25M	5908254800184	Schuko (typ F)	1100W / 4,8A	3200W / 13,9A	4 x 2P+Z 4 x 2P+E	H05VV-F 3 x 1,5 mm ²	25m	●
OR-AE-13155(GS)/50M	5908254800191	Schuko (typ F)	1100W / 4,8A	3200W / 13,9A	4 x 2P+Z 4 x 2P+E	H05VV-F 3 x 1,5 mm ²	50m	●



Profesjonalne przedłużacze bębnowe

PROFESSIONAL CABLE REELS

Główne cechy / Main features

Typ izolacji: guma olejoodporna
Type of insulation: oil proof rubber



Stałe gniazda
Fixed sockets



Odporne na warunki pogodowe: IP44
Weatherproof: IP44



Stojak typu CUBE
CUBE type stand



Symbol Product no.	EAN	Standard gniazd Standard of the socket	Max. obciążenie / prąd przewód zwinięty Max. load / current coiled wire	Max. obciążenie / prąd przewód rozwinięty Max. load / current loose wire	Ilość gniazd sieciowych Number of sockets	Rodzaj przewodu Type of cable	Długość przewodu Length of the wire	Stałe gniazda Fixed sockets
OR-AE-13156/20M	5900378655480	french (typ E)	1100W / 4,8A	3200W / 13,9A	4 x 2P+Z 4 x 2P+E	H07RN - F 3 x 2,5 mm ²	20m	●
OR-AE-13157/30M	5908254804304	french (typ E)	1100W / 4,8A	3200W / 13,9A	4 x 2P+Z 4 x 2P+E	H07RN - F 3 x 2,5 mm ²	30m	●
OR-AE-13157/40M	5900378655497	french (typ E)	1100W / 4,8A	3200W / 13,9A	4 x 2P+Z 4 x 2P+E	H07RN - F 3 x 2,5 mm ²	40m	●
OR-AE-13156(GS)/20M	5908254800207	Schuko (typ F)	1100W / 4,8A	3200W / 13,9A	4 x 2P+Z 4 x 2P+E	H07RN - F 3 x 2,5 mm ²	20m	●
OR-AE-13157(GS)/30M	5908254804311	Schuko (typ F)	1100W / 4,8A	3200W / 13,9A	4 x 2P+Z 4 x 2P+E	H07RN - F 3 x 2,5 mm ²	30m	●
OR-AE-13157(GS)/40M	5908254800214	Schuko (typ F)	1100W / 4,8A	3200W / 13,9A	4 x 2P+Z 4 x 2P+E	H07RN - F 3 x 2,5 mm ²	40m	●



Gniazda meblowe

FURNITURE SOCKETS

Gniazda wpuszczane FLUSH MOUNTED SOCKETS	224
Gniazda nabladowe COURTERTOP SOCKETS	246
Gniazda podszafkowe UNDER-CABINET SOCKETS	248



Dostępne funkcje:

AVAILABLE FUNCTIONS



Materiał: stop cynku + blacha stalowa
Material: zinc alloy + steel sheet



Ładowarka USB
USB charger



Porty USB
USB ports



Naciśnij by otworzyć
Press to open



Warianty produktu:

AVAILABLE VARIANTS

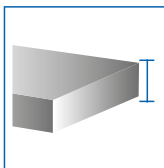









Gruby prostokątny rant - 7 mm
Thick rectangle edge - 7 mm



OR-AE-1335/G
OR-AE-1335/B
OR-AE-1338/G
OR-AE-1338/B



OR-AE-1324/G
OR-AE-1324/B

 Symbol Product no.	 EAN	 Ilość gniazd sieciowych Number of sockets	 Wersja french French type	 Porty USB USB ports	 Kabel zasilający Power cable	 Kolor Color	 szer./wys./gt. [mm] width x height x depth [mm]
OR-AE-1335/G	5901752486690	3 x 2P+Z (max. 3600 W)	●			srebrny silver	265 / 130 / 69
OR-AE-1335/B	5901752486683	3 x 2P+Z (max. 3600 W)	●			czarny black	265 / 130 / 69
OR-AE-1338/G	5901752487109	3 x 2P+Z (max. 3600 W)	●		• 1,5 m	srebrny silver	265 / 130 / 69
OR-AE-1338/B	5901752487093	3 x 2P+Z (max. 3600 W)	●		• 1,5 m	czarny black	265 / 130 / 69
OR-AE-1324/G	5901752485747	2 x 2P+Z (max. 3600 W)	●	3 x USB		srebrny silver	265 / 119 / 67
OR-AE-1324/B	5901752485730	2 x 2P+Z (max. 3600 W)	●	3 x USB		czarny black	265 / 119 / 67

Brak ładowarki USB
No USB charger

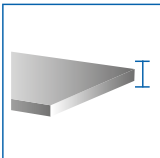









Cienki prostokątny rant - 2 mm
Thin rectangle edge - 2 mm



OR-AE-1371/G
OR-AE-1371(GS)/G
OR-AE-1372/G
OR-AE-1372(GS)/G



OR-AE-1371/B
OR-AE-1371(GS)/B
OR-AE-1372/B
OR-AE-1372(GS)/B

 Symbol Product no.	 EAN	 Ilość gniazd sieciowych Number of sockets	 Wersja french French type	 Wersja Schuko Schuko type	 Kabel zasilający Power cable	 Kolor Color	 szer./wys./gt. [mm] W/H/D [mm]
OR-AE-1371/G	5901752488458	3 x 2P+Z (max. 3600 W)	●	○		srebrny silver	265 / 130 / 64
OR-AE-1371(GS)/G	5908254810831	3 x 2P+Z (max. 3600 W)	○	●		srebrny silver	265 / 130 / 64
OR-AE-1371/B	5901752488465	3 x 2P+Z (max. 3600 W)	●	○		czarny black	265 / 130 / 64
OR-AE-1371(GS)/B	5908254810824	3 x 2P+Z (max. 3600 W)	○	●		czarny black	265 / 130 / 64
OR-AE-1372/G	5901752488489	3 x 2P+Z (max. 3600 W)	●	○	1,5 m	srebrny silver	265 / 130 / 64
OR-AE-1372(GS)/G	5908254819971	3 x 2P+Z (max. 3600 W)	○	●	1,5 m	srebrny silver	265 / 130 / 64
OR-AE-1372/B	5901752488496	3 x 2P+Z (max. 3600 W)	●	○	1,5 m	czarny black	265 / 130 / 64
OR-AE-1372(GS)/B	5908254819964	3 x 2P+Z (max. 3600 W)	○	●	1,5 m	czarny black	265 / 130 / 64



Cienki frezowany rant - 2 mm Thin milled edge - 2 mm



OR-AE-1336/G
OR-AE-1336(GS)



OR-AE-1336/B
OR-AE-1336(B)(GS)



OR-AE-1336/C
OR-AE-1336(GS)/C



OR-AE-1336/BR
OR-AE-1336(GS)/BR



OR-AE-1336/GR
OR-AE-1336(GS)/GR



OR-AE-1337/G
OR-AE-1337(GS)



OR-AE-1337/B
OR-AE-1337(B)(GS)



OR-AE-1337/C
OR-AE-1337(GS)/C



OR-AE-1337/BR
OR-AE-1337(GS)/BR



OR-AE-1337/GR
OR-AE-1337(GS)/GR



OR-AE-13109/G
OR-AE-13109(GS)/G



OR-AE-13109/B
OR-AE-13109(GS)/B



OR-AE-13109/C
OR-AE-13109(GS)/C



OR-AE-13109/BR
OR-AE-13109(GS)/BR



OR-AE-13109/GR
OR-AE-13109(GS)/GR



OR-AE-13126/G
OR-AE-13126(GS)/G



OR-AE-13126/B
OR-AE-13126(GS)/B











OR-AE-13126/C
OR-AE-13126(GS)/C



OR-AE-13126/BR
OR-AE-13126(GS)/BR



OR-AE-13126/GR
OR-AE-13126(GS)/GR

 Symbol Product no.	 EAN	 Ilość gniazd sieciowych Number of sockets	 Wersja french French type	 Wersja Schuko Schuko type	 Ładowarka USB USB charger	 Kabel zasilający Power cable	 Kolor Color	 szer./wys./gt. [mm] W/H/D [mm]
OR-AE-1336/G	5901752486935	3 x 2P+Z (max. 3600 W)	●	○			srebrny silver	265 / 119 / 67
OR-AE-1336(GS)	5902560328967	3 x 2P+Z (max. 3600 W)	○	●			srebrny silver	265 / 119 / 67
OR-AE-1336/B	5901752486942	3 x 2P+Z (max. 3600 W)	●	○			czarny black	265 / 119 / 67
OR-AE-1336(B)(GS)	5902560328950	3 x 2P+Z (max. 3600 W)	○	●			czarny black	265 / 119 / 67
OR-AE-1336/C	5902560328929	3 x 2P+Z (max. 3600 W)	●	○			złoty gold	265 / 119 / 67
OR-AE-1336(GS)/C	5908254819988	3 x 2P+Z (max. 3600 W)	○	●			złoty gold	265 / 119 / 67

OR-AE-1336/BR	5902560328936	3 x 2P+Z (max. 3600 W)	●	○			mosiądz brass	265 / 119 / 67
OR-AE-1336(GS)/BR	5908254819995	3 x 2P+Z (max. 3600 W)	○	●			mosiądz brass	265 / 119 / 67
OR-AE-1336/GR	5902560328943	3 x 2P+Z (max. 3600 W)	●	○			grafit graphite	265 / 119 / 67
OR-AE-1336(GS)/GR	5908254820007	3 x 2P+Z (max. 3600 W)	○	●			grafit graphite	265 / 119 / 67
OR-AE-1337/G	5901752486959	3 x 2P+Z (max. 3600 W)	●	○		1,5 m	srebrny silver	265 / 119 / 67
OR-AE-1337(G)/GS	5902560329063	3 x 2P+Z (max. 3600 W)	○	●		1,5 m	srebrny silver	265 / 119 / 67
OR-AE-1337(G)/3M	5908254817854	3 x 2P+Z (max. 3600 W)	●	○		3 m	srebrny silver	265 / 119 / 67
OR-AE-1337/B	5901752486966	3 x 2P+Z (max. 3600 W)	●	○		1,5 m	czarny black	265 / 119 / 67
OR-AE-1337(B)/3M	5908254817847	3 x 2P+Z (max. 3600 W)	●	○		3 m	czarny black	265 / 119 / 67
OR-AE-1337(B)/GS	5902560329056	3 x 2P+Z (max. 3600 W)	○	●		1,5 m	czarny black	265 / 119 / 67
OR-AE-1337/C	5902560329025	3 x 2P+Z (max. 3600 W)	●	○		1,5 m	złoty gold	265 / 119 / 67
OR-AE-1337(GS)/C	5908254820014	3 x 2P+Z (max. 3600 W)	○	●		1,5 m	złoty gold	265 / 119 / 67
OR-AE-1337/BR	5902560329032	3 x 2P+Z (max. 3600 W)	●	○		1,5 m	mosiądz brass	265 / 119 / 67
OR-AE-1337(GS)/BR	5908254820021	3 x 2P+Z (max. 3600 W)	○	●		1,5 m	mosiądz brass	265 / 119 / 67
OR-AE-1337/GR	5902560329049	3 x 2P+Z (max. 3600 W)	●	○		1,5 m	grafit graphite	265 / 119 / 67
OR-AE-1337(GS)/GR	5908254820038	3 x 2P+Z (max. 3600 W)	○	●		1,5 m	grafit graphite	265 / 119 / 67
OR-AE-13109/G	5902560322064	3 x 2P+Z (max. 3600 W)	●	○	2 x USB 5V DC / 2,1A		srebrny silver	265 / 119 / 67
OR-AE-13109(GS)/G	5908254820052	3 x 2P+Z (max. 3600 W)	○	●	2 x USB 5V DC / 2,1A		srebrny silver	265 / 119 / 67
OR-AE-13109/B	5902560322040	3 x 2P+Z (max. 3600 W)	●	○	2 x USB 5V DC / 2,1A		czarny black	265 / 119 / 67
OR-AE-13109(GS)/B	5908254820045	3 x 2P+Z (max. 3600 W)	○	●	2 x USB 5V DC / 2,1A		czarny black	265 / 119 / 67
OR-AE-13109/C	5908254820069	3 x 2P+Z (max. 3600 W)	●	○	2 x USB 5V DC / 2,1A		złoty gold	265 / 119 / 67
OR-AE-13109(GS)/C	5908254820076	3 x 2P+Z (max. 3600 W)	○	●	2 x USB 5V DC / 2,1A		złoty gold	265 / 119 / 67
OR-AE-13109/BR	5908254820106	3 x 2P+Z (max. 3600 W)	●	○	2 x USB 5V DC / 2,1A		mosiądz brass	265 / 119 / 67
OR-AE-13109(GS)/BR	5908254820113	3 x 2P+Z (max. 3600 W)	○	●	2 x USB 5V DC / 2,1A		mosiądz brass	265 / 119 / 67
OR-AE-13109/GR	5908254820083	3 x 2P+Z (max. 3600 W)	●	○	2 x USB 5V DC / 2,1A		grafit graphite	265 / 119 / 67
OR-AE-13109(GS)/GR	5908254820090	3 x 2P+Z (max. 3600 W)	○	●	2 x USB 5V DC / 2,1A		grafit graphite	265 / 119 / 67
OR-AE-13126/G	5902560328455	3 x 2P+Z (max. 3600 W)	●	○	2 x USB 5V DC / 2,1A	1,5 m	srebrny silver	265 / 119 / 67
OR-AE-13126(G)/3M	5908254817878	3 x 2P+Z (max. 3600 W)	●	○	2 x USB 5V DC / 2,1A	3 m	srebrny silver	265 / 119 / 67
OR-AE-13126(GS)/G	5908254820137	3 x 2P+Z (max. 3600 W)	○	●	2 x USB 5V DC / 2,1A	1,5 m	srebrny silver	265 / 119 / 67
OR-AE-13126/B	5902560328066	3 x 2P+Z (max. 3600 W)	●	○	2 x USB 5V DC / 2,1A	1,5 m	czarny black	265 / 119 / 67
OR-AE-13126(B)/3M	5908254817861	3 x 2P+Z (max. 3600 W)	●	○	2 x USB 5V DC / 2,1A	3 m	czarny black	265 / 119 / 67
OR-AE-13126(GS)/B	5908254820120	3 x 2P+Z (max. 3600 W)	○	●	2 x USB 5V DC / 2,1A	1,5 m	czarny black	265 / 119 / 67
OR-AE-13126/C	5908254820144	3 x 2P+Z (max. 3600 W)	●	○	2 x USB 5V DC / 2,1A	1,5 m	złoty gold	265 / 119 / 67
OR-AE-13126(GS)/C	5908254820151	3 x 2P+Z (max. 3600 W)	○	●	2 x USB 5V DC / 2,1A	1,5 m	złoty gold	265 / 119 / 67
OR-AE-13126/BR	5908254820182	3 x 2P+Z (max. 3600 W)	●	○	2 x USB 5V DC / 2,1A	1,5 m	mosiądz brass	265 / 119 / 67
OR-AE-13126(GS)/BR	5908254820199	3 x 2P+Z (max. 3600 W)	○	●	2 x USB 5V DC / 2,1A	1,5 m	mosiądz brass	265 / 119 / 67
OR-AE-13126/GR	5908254820168	3 x 2P+Z (max. 3600 W)	●	○	2 x USB 5V DC / 2,1A	1,5 m	grafit graphite	265 / 119 / 67
OR-AE-13126(GS)/GR	5908254820175	3 x 2P+Z (max. 3600 W)	○	●	2 x USB 5V DC / 2,1A	1,5 m	grafit graphite	265 / 119 / 67



Dostępne funkcje:

AVAILABLE FUNCTIONS



Szczelina wykończona szczotką przeciwkurzową.
Anti-dust brush in the retractable top housing



Materiał: stop cynku + blacha stalowa
Material: zinc alloy + steel sheet



Gniazdo sieciowe RJ45
Network sockets RJ45



Ładowarka USB
USB charger



Cienki frezowany rant - 2mm
Thin milled edge - 2mm

Szczotkowana powierzchnia
Brushed finish



OR-AE-13127(GS)/B
OR-AE-13125/B
OR-AE-13125/B(GS)

Symbol Product no.	EAN	Ilość gniazd sieciowych Number of sockets	Wersja french French type	Wersja Schuko Schuko type	Ładowarka USB USB charger	Gniazdo sieciowe Network socket	Kabel zasilający Power cable	szer./wys./gl. [mm] width x height x depth [mm]
OR-AE-13127(GS)/B	5902560328202	3 x 2P+Z (max. 3600 W)	○	●			• 1,5 m	265 / 130 / 77
OR-AE-13125/B	5902560328684	2 x 2P+Z (max. 3600 W)	●	○	• 2 x USB 5V DC / 2,1A	• 2 x RJ45	• 1,5 m	265 / 130 / 77
OR-AE-13125/B(GS)	5902560328042	2 x 2P+Z (max. 3600 W)	○	●	• 2 x USB 5V DC / 2,1A	• 2 x RJ45	• 1,5 m	265 / 130 / 77



OR-AE-1361



OR-AE-1362

Dostępne funkcje:

AVAILABLE FUNCTIONS









Szczelina wykończona szczotką przeciwkurzową.
Anti-dust brush in the retractable top housing



Materiał: tworzywo sztuczne
Material: plastic



Ładowarka USB
USB charger

 Symbol Product no.	 EAN	 Ilość gniazd sieciowych Number of sockets	 Wersja french French type	 Ładowarka USB USB charger	 Kabel zasilający Power cable	 szer./wys./gt. [mm] width x height x depth [mm]
OR-AE-1361	5901752487710	3 x 2P+Z (max. 3680 W)	●		● 1,8 m	228,5 / 158 / 80
OR-AE-1362	5901752487727	3 x 2P+Z (max. 3680 W)	●	● 2 x USB 5V DC / 2,1A	● 1,8 m	277,1 / 158 / 80



Dostępne funkcje:

AVAILABLE FUNCTIONS



Materiał: tworzywo sztuczne + nikiel
Material: plastic + nickel



Naciśnij by otworzyć
Press to open



Ładowarka USB
USB charger



Cienki frezowany rant - 2mm
Thin milled edge - 2mm



OR-AE-1363



OR-AE-1364
OR-AE-1364(GS)

Symbol Product no.	EAN	Ilość gniazd sieciowych Number of sockets	Wersja french French type	Wersja Schuko Schuko type	Ładowarka USB USB charger	Kabel zasilający Power cable	szer./wys./gt. [mm] W/H/D [mm]
OR-AE-1363	590175248773	3 x 2P+Z (max. 3680 W)	●	○		1,8 m	270 / 112 / 94
OR-AE-1364	5901752487741	3 x 2P+Z (max. 3680 W)	●	○	2 x USB 5V DC / 2,1A	1,8 m	311 / 112 / 94
OR-AE-1364(GS)	5908254819957	3 x 2P+Z (max. 3680 W)	○	●	2 x USB 5V DC / 2,1A	1,8 m	311 / 112 / 94



OR-GM-9009/B-G



OR-GM-9014(GS)/B-G



OR-GM-9016/B-G
OR-GM-9016(GS)/B-G

Dostępne funkcje:

AVAILABLE FUNCTIONS



Materiał: tworzywo sztuczne + stal nierdzewna INOX
Material: plastic + stainless steel (INOX)



Naciśnij by otworzyć
Press to open

Symbol Product no.	EAN	Ilość gniazd sieciowych Number of sockets	Wersja french French type	Wersja Schuko Schuko type	Ładowarka USB USB charger	Gniazdo HDMI HDMI port	Kabel zasilający Power cable	szer./wys./gt. [mm] W/H/D [mm]
OR-GM-9009/B-G	5900378654872	3 x 2P+Z (max. 3680 W)	●	○	2 x USB (typ A) 5V DC / 2,4A	○	2 m	273,5 / 92,5 / 97,2
OR-GM-9014(GS)/B-G	5908254804137	3 x 2P+Z (max. 3680 W)	○	●	2 x USB (typ A+C) 5V DC / 3,0A	○	2 m	273,5 / 92,5 / 97,2
OR-GM-9016/B-G	5908254812279	2 x 2P+Z (max. 3680 W)	●	○	2 x USB (typ A) 5V DC / 2,4A	●	2 m	246 / 58 / 94
OR-GM-9016(GS)/B-G	5908254812286	2 x 2P+Z (max. 3680 W)	○	●	2 x USB (typ A) 5V DC / 2,4A	●	2 m	246 / 58 / 94



Dostępne funkcje:

AVAILABLE FUNCTIONS



Mechanizm elektrycznego otwierania i zamykania
Electric opening and closing mechanism



Inteligentny system ochrony zapobiegający przytraśnięciu
Intelligent anti-slam safety system



Materiał: aluminium + tworzywo sztuczne
Material: aluminium + plastic



Gniazdo sieciowe RJ45
Network sockets RJ45



Gniazdo HDMI
HDMI socket



Cienki frezowany rant - 2mm
Thin milled edge - 2mm



OR-AE-13110
OR-AE-13110(GS)

Symbol Product no.	EAN	Ilość gniazd sieciowych Number of sockets	Wersja french French type	Wersja Schuko Schuko type	Gniazdo HDMI HDMI socket	Gniazdo sieciowe Network socket	Kabel zasilający Power cable	szer./wys./gł. [mm] width x height x depth [mm]
OR-AE-13110	5902560322088	3 x 2P+Z (max. 2500W)	●	○	1 x HDMI	2 x RJ45	1,5 m	393 / 111 / 102
OR-AE-13110(GS)	5908254810855	3 x 2P+Z (max. 2500W)	○	●	1 x HDMI	2 x RJ45	1,5 m	393 / 111 / 102



Gniazdo wpuszczane w blat. TAKIE JAK POTRZEBUJESZ.

Recessed furniture connection panel with socket modules of your own choice.



OR-GM-9010/W



OR-GM-9010/G



OR-GM-9010/B

NOEN kaseta meblowa wpuszczana w blat z wymienną ramką PVC

NOEN recessed furniture connection panel with a replaceable PVC frame

Pusta aluminiowa kaseta meblowa NOEN z wymienną ramką PVC wpuszczana w blat. Jest to uniwersalne rozwiązanie, które umożliwia zamocowanie 3 gniazd modułowych NOEN o wymiarach 45x45mm lub 6 gniazd o wymiarach 22,5x45mm (gniazda prądowe, HDMI, USB, RJ45, RJ11), w konfiguracji odpowiadającej preferencjom użytkownika. Urządzenie przeznaczone jest do montażu w biurkach, blatach i stołach. Posiada zamykaną pokrywę oraz przewód o długości 1,5m. Dostępne kolory: biały, czarny, srebrny.









Recessed furniture connection panel NOEN is composed of an empty aluminium case and a replaceable PVC frame. It is a convenient solution that enables installation of 3 NOEN socket or port modules (45x45mm each) or 6 modules (22.5x45mm each), in combination that suits preferences of the user (power sockets, HDMI, USB, RJ45, RJ11). This connection panel can be integrated into the surface of conference tables, office desks and kitchen tables. It has a protective cover and a cable 1.5m long. Available colours: white, black, silver.



Materiał: tworzywo sztuczne + aluminium
Material: plastic + aluminium































































Cienki frezowany rant - 2mm
Thin milled edge - 2mm

	 Symbol Product no.	 EAN	 Wymienne moduły Replaceable modules	 Kabel zasilający Power cable	 Kolor Color	 szer./wys./gł. [mm] width x height x depth [mm]
	OR-GM-9010/W	5900378655893	3 x 45 mm lub / or 6 x 22,5 mm	• 1,5 m	biały white	240 / 120 / 70
	OR-GM-9010/G	5900378655909	3 x 45 mm lub / or 6 x 22,5 mm	• 1,5 m	srebrny silver	240 / 120 / 70
	OR-GM-9010/B	5900378655916	3 x 45 mm lub / or 6 x 22,5 mm	• 1,5 m	czarny black	240 / 120 / 70

Dostępne gniazda oraz porty modułowe przeznaczone do kaset NOEN

Socket modules and ports available for configuration of NOEN connection panels

	 Symbol Product no.	 EAN	 Rodzaj gniazda Type of socket	 Kolor Color	 szer./wys. [mm] width x height [mm]
	OR-GM-9010/B/FR	5900378655923	 Wersja french French type	czarny black	45 / 45
	OR-GM-9010/W/FR	5900378655930	 Wersja french French type	biały white	45 / 45
	OR-GM-9010/B/FR45	5908254805554	 Wersja french French type	czarny black	45 / 45
	OR-GM-9010/W/FR45	5908254805547	 Wersja french French type	biały white	45 / 45
	OR-GM-9010/B/GS	5900378655947	 Wersja Schuko Schuko type	czarny black	45 / 45
	OR-GM-9010/W/GS	5900378655954	 Wersja Schuko Schuko type	biały white	45 / 45
	OR-GM-9010/B/GS45	5908254805578	 Wersja Schuko Schuko type	czarny black	45 / 45
	OR-GM-9010/W/GS45	5908254805561	 Wersja Schuko Schuko type	biały white	45 / 45
	OR-GM-9010/B/UK	5900378655961	 Wersja multifunkcyjna (UK, USA, AU, CN) Multifunctional type (UK, USA, AU, CN)	czarny black	45 / 45
	OR-GM-9010/B/USB	5900378655978	 1 x USB (5V DC / 2,1A)	czarny black	22,5 / 45
	OR-GM-9010/W/USB	5900378655985	 1 x USB (5V DC / 2,1A)	biały white	22,5 / 45
	OR-GM-9010/B/USBX2	5900378655992	 2 x USB (5V DC / 2,1A)	czarny black	45 / 45

	OR-GM-9010/W/USBX2	5900378656005	 2 x USB (5V DC / 2,1A)	biały white	45 / 45
	OR-GM-9010/B/USBAC	5908254803581	 USB A + USB C (5V DC / 2,1A)	czarny black	45 / 45
	OR-GM-9010/B/RJ45	5900378656012	 Gniazdo sieciowe RJ45 Network socket RJ45	czarny black	45 / 45
	OR-GM-9010/W/RJ45	5900378656029	 Gniazdo sieciowe RJ45 Network socket RJ45	biały white	22,5 / 45
	OR-GM-9010/B/RJ11	5900378656036	 Gniazdo telefoniczne RJ11 Phone socket RJ45	czarny black	22,5 / 45
	OR-GM-9010/W/RJ11	5900378656043	 Gniazdo telefoniczne RJ11 Phone socket RJ45	biały white	22,5 / 45
	OR-GM-9010/B/USBDATA	5900378656050	 USB DATA 2.0 (piny) USB DATA 2.0 (pins)	czarny black	22,5 / 45
	OR-GM-9010/W/USBDATA	5900378656067	 USB DATA 2.0 (piny) USB DATA 2.0 (pins)	biały white	22,5 / 45
	OR-GM-9010/B/USBDAT1	5908254810015	 USB DATA 2.0 (przelotka) USB DATA 2.0 (double-sided)	czarny black	22,5 / 45
	OR-GM-9010/W/USBDAT1	5908254810022	 USB DATA 2.0 (przelotka) USB DATA 2.0 (double-sided)	biały white	22,5 / 45
	OR-GM-9010/B/HDMI	5900378656074	 Gniazdo HDMI HDMI socket	czarny black	22,5 / 45
	OR-GM-9010/W/HDMI	5900378656081	 Gniazdo HDMI HDMI socket	biały white	22,5 / 45
	OR-GM-9010/B/USBQ	5900378658658	 1 x USB (3A / 5V; 2A / 9V; 1,5A / 12V) Instalacja: tylko z ramką bez separatorów 1 x USB (3A / 5V; 2A / 9V; 1,5A / 12V) Installation: only in frame without separators	czarny black	45 / 45
	OR-GM-9010/W/USBQ	5900378658641	 1 x USB (3A / 5V; 2A / 9V; 1,5A / 12V) Instalacja: tylko z ramką bez separatorów 1 x USB (3A / 5V; 2A / 9V; 1,5A / 12V) Installation: only in frame without separators	biały white	45 / 45
	OR-GM-9010/B/EP OR-GM-9010/W/EP	5900378656098 5900378656104	 Zaślepka Empty plate	czarny / black biały / white	22,5 / 45
	OR-GM-9010/B/RM OR-GM-9010/W/RM	5908254805530 5908254805523	 Ramka bez separatorów do kaset Frame without separators	czarny / black biały / white	175 / 59



Dostępne funkcje:

AVAILABLE FUNCTIONS



Ładowarka USB
USB charger



Naciśnij by otworzyć
Press to open

Opcje wykończenia:

FINISHING VARIANTS



Materiał: tworzywo sztuczne + metal lakierowany
Material: plastic + painted metal



Materiał: tworzywo sztuczne + stal nierdzewna INOX
Material: plastic + stainless steel (INOX)

Warianty produktu:

AVAILABLE VARIANTS

szer./wys./gt. [mm]
W/H/D [mm]

OR-AE-1347 OR-AE-1348	Ø 71,4 x 284 [mm]
OR-AE-1349 OR-AE-1350	Ø 71,4 x 315,1 [mm]

szer./wys./gt. [mm]
W/H/D [mm]

OR-AE-1355 OR-AE-1356	Ø 90 x 284 [mm]
OR-AE-1357	Ø 90 x 322 [mm]

szer./wys./gt. [mm]
W/H/D [mm]

OR-AE-1351 OR-AE-1352	Ø 115 x 293 [mm]
OR-AE-1353 OR-AE-1354	Ø 115 x 339 [mm]

	Symbol Product no.	EAN	Otwór montażowy Mounting hole	Ilość gniazd sieciowych Number of sockets	French French	Schuko Schuko	Ładowarka USB USB charger	Kolor / materiał Color / material	Przewód Cable
	OR-AE-1347	5901752487574	Ø 60 mm	3 x 2P+Z (max. 3680 W)	●	○		metal lakierowany (srebrny) painted metal (silver)	1,8 m
	OR-AE-1347(GS)	5908254810800	Ø 60 mm	3 x 2P+Z (max. 3680 W)	○	●		metal lakierowany (srebrny) painted metal (silver)	1,8 m
	OR-AE-1347/B	5908254820236	Ø 60 mm	3 x 2P+Z (max. 3680 W)	●	○		metal lakierowany (czarny) painted metal (black)	1,8 m
	OR-AE-1347(GS)/B	5908254820243	Ø 60 mm	3 x 2P+Z (max. 3680 W)	○	●		metal lakierowany (czarny) painted metal (black)	1,8 m
	OR-AE-1348	5901752487581	Ø 60 mm	3 x 2P+Z (max. 3680 W)	●	○		stal nierdzewna INOX stainless steel (INOX)	1,8 m
	OR-AE-1348(GS)	5908254810817	Ø 60 mm	3 x 2P+Z (max. 3680 W)	○	●		stal nierdzewna INOX stainless steel (INOX)	1,8 m
	OR-AE-1349	5901752487598	Ø 60 mm	3 x 2P+Z (max. 3680 W)	●	○	2 x USB 5V DC / 2,1A	metal lakierowany (srebrny) painted metal (silver)	1,8 m
	OR-AE-1349(GS)	5908254822292	Ø 60 mm	3 x 2P+Z (max. 3680 W)	○	●	2 x USB 5V DC / 2,1A	metal lakierowany (srebrny) painted metal (silver)	1,8 m
	OR-AE-1349/B	5908254820250	Ø 60 mm	3 x 2P+Z (max. 3680 W)	●	○	2 x USB 5V DC / 2,1A	metal lakierowany (czarny) painted metal (black)	1,8 m
	OR-AE-1349(GS)/B	5908254820267	Ø 60 mm	3 x 2P+Z (max. 3680 W)	○	●	2 x USB 5V DC / 2,1A	metal lakierowany (czarny) painted metal (black)	1,8 m
OR-AE-1350	5901752487604	Ø 60 mm	3 x 2P+Z (max. 3680 W)	●	○	2 x USB 5V DC / 2,1A	stal nierdzewna INOX stainless steel (INOX)	1,8 m	
	OR-AE-1355	5901752487659	Ø 80 mm	3 x 2P+Z (max. 3680 W)	●	○		metal lakierowany (srebrny) painted metal (silver)	1,8 m
	OR-AE-1356	5901752487666	Ø 80 mm	3 x 2P+Z (max. 3680 W)	●	○		stal nierdzewna INOX stainless steel (INOX)	1,8 m
	OR-AE-1357	5901752487673	Ø 80 mm	3 x 2P+Z (max. 3680 W)	●	○	2 x USB 5V DC / 2,1A	metal lakierowany (srebrny) painted metal (silver)	1,8 m
	OR-AE-1351	5901752487611	Ø 100 mm	3 x 2P+Z (max. 3680 W)	●	○		metal lakierowany (srebrny) painted metal (silver)	1,8 m
	OR-AE-1352	5901752487628	Ø 100 mm	3 x 2P+Z (max. 3680 W)	●	○		stal nierdzewna INOX stainless steel (INOX)	1,8 m
	OR-AE-1353	5901752487635	Ø 100 mm	3 x 2P+Z (max. 3680 W)	●	○	2 x USB 5V DC / 2,1A	metal lakierowany (srebrny) painted metal (silver)	1,8 m
	OR-AE-1354	5901752487642	Ø 100 mm	3 x 2P+Z (max. 3680 W)	●	○	2 x USB 5V DC / 2,1A	stal nierdzewna INOX stainless steel (INOX)	1,8 m



OR-AE-1341
OR-AE-1342
OR-AE-1380
OR-AE-1381

OR-GM-9017



Tworzywo sztuczne + metal lakierowany
Plastic + painted metal



Tworzywo sztuczne + stal nierdzewna INOX
Plastic + stainless steel (INOX)



Ładowarka bezprzewodowa (Qi)
Wireless charging (Qi)











USB Quick charge (QC 3.0)
USB Quick charge (QC 3.0)



Ładowarka USB
USB charger



Naciśnij by otworzyć
Press to open

 Symbol Product no.	 EAN	 Otwór montażowy Mounting hole	 Ilość gniazd sieciowych Number of sockets	 French French	 Schuko Schuko	 Ładowarka USB USB charger	 Kolor / materiał Color / material	 Przewód Cable
OR-AE-1341	5901752487437	Ø 100 mm	4 x 2P+Z (max. 3680 W)	●	○		metal lakierowany (srebrny) painted metal (silver)	1,5 m
OR-AE-1341(GS)	5900378650850	Ø 100 mm	4 x 2P+Z (max. 3680 W)	○	●		metal lakierowany (srebrny) painted metal (silver)	1,5 m
OR-AE-1342	5901752487444	Ø 100 mm	3 x 2P+Z (max. 3680 W)	●	○	2 x USB 5V DC / 2,4A	metal lakierowany (srebrny) painted metal (silver)	1,5 m
OR-AE-1342(GS)	5900378650874	Ø 100 mm	3 x 2P+Z (max. 3680 W)	○	●	2 x USB 5V DC / 2,4A	metal lakierowany (srebrny) painted metal (silver)	1,5 m
OR-AE-1380	5901752489639	Ø 100 mm	4 x 2P+Z (max. 3680 W)	●	○		stal nierdzewna INOX stainless steel (INOX)	1,5 m
OR-AE-1381	5901752489646	Ø 100 mm	3 x 2P+Z (max. 3680 W)	●	○	2 x USB 5V DC / 2,4A	stal nierdzewna INOX stainless steel (INOX)	1,5 m
OR-AE-1381(GS)	5900378655718	Ø 100 mm	3 x 2P+Z (max. 3680 W)	○	●	2 x USB 5V DC / 2,4A	stal nierdzewna INOX stainless steel (INOX)	1,5 m
OR-GM-9017	5908254816161	Ø 100 mm	3 x 2P+Z (max. 2300 W)	●	○	2 x USB 5V DC / 3,0A 9V DC / 2,0A 12V DC / 1,5A	metal lakierowany (czarny) painted metal (black)	1,5 m
OR-GM-9017(GS)	5908254816178	Ø 100 mm	3 x 2P+Z (max. 2300 W)	○	●	2 x USB 5V DC / 3,0A 9V DC / 2,0A 12V DC / 1,5A	metal lakierowany (czarny) painted metal (black)	1,5 m



Hermetyczne gniazdo elektryczne

Hermetic, flush-mounted socket



OR-AE-1397
OR-AE-1397(GS)

Materiał: stal nierdzewna
Material: stainless steel



OR-AE-1397MB
OR-AE-1397(GS)MB

Wiatroszczelna puszka
Windproof junction box



OR-AE-1398



OR-AE-1398MB



Materiał: stal nierdzewna
Material: stainless steel



Kąt otwarcia pokrywy: 90°
Opening angle: 90°



Montaż w standardowej puszcze elektrycznej Ø 60 mm
Installation in a standard flush box, diameter Ø 60 mm



Wiatroszczelność (OR-AE-1397MB i OR-AE-1398MB)
Windproof (OR-AE-1397MB i OR-AE-1398MB)

Symbol Product no.	EAN	Ilość gniazd sieciowych Number of sockets	Wersja french French type	Wersja Schuko Schuko type	Stopień ochrony Protection rating	szer./wys./gt. [mm] W/H/D [mm]
OR-AE-1397	5902560322101	1 x 2P+Z (max. 3680 W)	●	○	IP55	86 / 86 / 57
OR-AE-1397(GS)	5908254810848	1 x 2P+Z (max. 3680 W)	○	●	IP44	86 / 86 / 57
OR-AE-1397MB	5908254815706	1 x 2P+Z (max. 3680 W)	●	○	IP55	86 / 86 / 57
OR-AE-1397(GS)MB	5908254815720	1 x 2P+Z (max. 3680 W)	○	●	IP44	86 / 86 / 57
OR-AE-1398	5902560322125	2 x 2P+Z (max. 3680 W)	●	○	IP55	157 / 86 / 57
OR-AE-1398MB	5908254815713	2 x 2P+Z (max. 3680 W)	●	○	IP55	157 / 86 / 57



OR-AE-1373
OR-AE-1373(GS)
OR-AE-1373/B
OR-AE-1373(GS)/B



OR-AE-13124
OR-AE-13124(GS)













Materiał: tworzywo sztuczne
Material: plastic



Materiał: tworzywo sztuczne + stal nierdzewna
Material: plastic + stainless steel



Przesuwana pokrywa
Sliding cover

 Symbol Product no.	 EAN	 Ilość gniazd sieciowych Number of sockets	 Otwór montażowy Mounting hole	 French French	 Schuko Schuko	 Ładowarka USB USB charger	 Kabel zasilający Power cable	 Kolor Color	 szer./wys./gt. [mm] W/H/D [mm]
OR-AE-1373	5901752488427	1 x 2P+Z (max. 3680 W)	Ø 60 mm	●	○	1 x USB 5V DC / 2,4 A	1,9 m	srebrny silver	Ø70 / 83
OR-AE-1373(GS)	5902560326079	1 x 2P+Z (max. 3680 W)	Ø 60 mm	○	●	1 x USB 5V DC / 2,4 A	1,9 m	srebrny silver	Ø70 / 83
OR-AE-1373/B	5908254804106	1 x 2P+Z (max. 3680 W)	Ø 60 mm	●	○	1 x USB 5V DC / 2,4 A	1,8 m	czarny black	Ø70 / 85
OR-AE-1373(GS)/B	5908254804113	1 x 2P+Z (max. 3680 W)	Ø 60 mm	○	●	1 x USB 5V DC / 2,4 A	1,8 m	czarny black	Ø70 / 85
OR-AE-13124	5902560327816	1 x 2P+Z (max. 3680 W)	Ø 60 mm	●	○	1 x USB 5V DC / 2,4 A	1,9 m	srebrny silver	100 / 70 / 85
OR-AE-13124(GS)	5900378654896	1 x 2P+Z (max. 3680 W)	Ø 60 mm	○	●	1 x USB 5V DC / 2,4 A	1,9 m	srebrny silver	100 / 70 / 85



Gniazdo wpuszczane w blat

Recessed desk socket



Adapter USB C do USB A
(w zestawie)
USB C to USB A adapter
(included)

Główne cechy / Main features

System EasyEject
EasyEject



Montaż: wpuszczane w blat
Installation: flush-fitting



Adapter USB C do USB A
USB C to USB A adapter

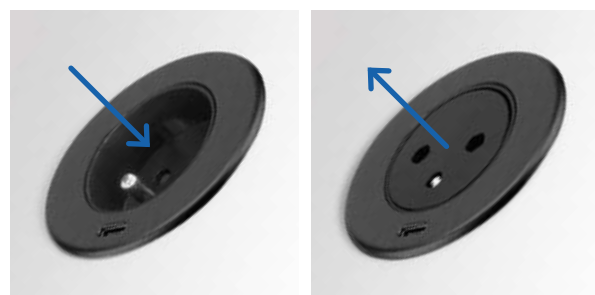

EasyEject

System łatwego wyciągania wtyczki
Przyciśnij wtyczkę, a system automatycznie ją wysunie

Easy plug removal system
Press down on the plug and the system will eject it automatically

Symbol Product no.	EAN	Ilość gniazd sieciowych Number of sockets	Otwór montażowy Mounting hole	Ładowarka USB USB charger	Wersja french French type	Kabel zasilający Power cable	Kolor Color	szer./wys./gt. [mm] W/H/D [mm]
OR-GM-9018	5908254819582	1 x 2P+Z (max.3680 W)	Ø 60 mm	2 x USB 3.0 5V DC / 3A 9V DC / 2A 12V DC / 1,5A	●	1,5 m	czarny black	Ø70 / 90

Ładowarka bezprzewodowa

Wireless charger



Główne cechy / Main features

Ładowarka bezprzewodowa (Qi)
Wireless charging (Qi)



Montaż: wpuszczane w blat
Installation: flush-fitting



Symbol Product no.	EAN	Zasilanie Power supply	Otwór montażowy Mounting hole	Ładowarka bezprzewodowa Wireless charging	Moc ładowania Rated power	Kolor Color	Materiał Material	szer./wys./gł. [mm] W/H/D [mm]
OR-GM-9020	5908254820687	5V DC 2A	Ø 60 mm	●	10W	czarny black	tworzywo sztuczne plastic	Ø 70 / 21

Ładowarka bezprzewodowa podblatowa

Hidden wireless charger

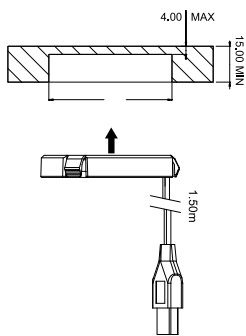

Główne cechy / Main features

Ładowarka bezprzewodowa (Qi)
Wireless charging (Qi)



Długość przewodu zasilającego: 1,5m
Wire length: 1,5m



Montaż: podblatowy
Installation: underside tabletop



Symbol Product no.	EAN	Zasilanie Power supply	Otwór montażowy Mounting hole	Ładowarka bezprzewodowa Wireless charging	Moc ładowania Rated power	Kolor Color	Materiał Material	szer./wys./gł. [mm] W/H/D [mm]
OR-GM-9021	5908254820694	5V DC 2A	Ø 60 mm	●	10W	czarny black	tworzywo sztuczne plastic	Ø 60 / 10



Ładowarki USB

USB chargers



OR-GM-9019/B
OR-GM-9019/G



OR-GM-9013/B



OR-AE-1367/B
OR-AE-1367/W













Materiał: tworzywo sztuczne
Material: plastic



Materiał: stop cynku + tworzywo sztuczne
Material: zinc alloy + plastic



Materiał: tworzywo sztuczne
Material: plastic

	 Symbol Product no.	 EAN	 Otwór montażowy Mounting hole	 Ładowarka USB USB charger	 Ładowarka bezprzewodowa Wireless charging	 Kolor Color	 Kabel zasilający Power cable	 szer./wys./gt. [mm] W/H/D [mm]
	OR-GM-9019/B	5908254822513	Ø 25 mm	2 x USB 5V DC / 3,4 A	○	czarny black		Ø 37 / 29,5
	OR-GM-9019/G	5908254820670	Ø 25 mm	2 x USB 5V DC / 3,4 A	○	srebrny silver		Ø 37 / 29,5
	OR-GM-9013/B	5908254802386	Ø 60 mm	3 x USB 5V DC / 3,1 A	○	czarny połysk black gloss	1,5 m	Ø 70 / 55
	OR-AE-1367/B	5901752488144	Ø 60 mm	1 x USB 5V DC / 2,1 A	●	czarny black		Ø 70 / 22
	OR-AE-1367/W	5901752488168	Ø 60 mm	1 x USB 5V DC / 2,1 A	●	biały white		Ø 70 / 22



Gniazdo meblowe Ø80mm wpuszczane w blat z ładowarką indukcyjną oraz ładowarką USB

Recessed desk socket Ø80mm with induction charger and USB charger

Kompaktowe gniazdo meblowe wpuszczane w blat można zastosować w każdym biurku. Posiada 1 gniazdo elektryczne, ładowarkę indukcyjną, ładowarkę USB oraz dodatkowe wymienne moduły, dzięki którym w jednym miejscu podłączysz sprzęt różnego typu. Wyposażone w 1,8 m kabel.

This desk socket can be integrated in a surface of every desk or table. It houses 1 electric socket, induction charger, USB charger and other replaceable modules by means of which appliances of different types can be connected all in one place. The cable is 1.8 m long.

Dostępne funkcje:

AVAILABLE FUNCTIONS



Materiał: tworzywo sztuczne
Material: plastic



Ładowarka USB
USB charger



Ładowarka bezprzewodowa
Wireless charging



Wymienne moduły 1 x HDMI / RJ45 / USB DATA
Replaceable modules 1 x HDMI / RJ45 / USB DATA



Wymienne moduły
Replaceable modules

OR-GM-9015/B

Ładowanie bezprzewodowe
Wireless charging

OR-GM-9015/W

Ładowanie bezprzewodowe
Wireless charging

Symbol Product no.	EAN	Ilość gniazd sieciowych Number of sockets	Otwór montażowy Mounting hole	Ładowarka USB USB charger	French	Schuko	Przewód Cable	Kolor Color	szer./wys. [mm] width x height [mm]
OR-GM-9015/B	5908254804823	1 x 2P+Z (max. 3680W)	Ø 80 mm	2 x USB (typ A + C) 5V DC / 2,4 A	●	○	• 1,8 m	czarny black	Ø 90 / 81
OR-GM-9015/W	5908254804816	1 x 2P+Z (max. 3680W)	Ø 80 mm	2 x USB (typ A + C) 5V DC / 2,4 A	●	○	• 1,8 m	biały white	Ø 90 / 81
OR-GM-9015(GS)/B	5908254810787	1 x 2P+Z (max. 3680W)	Ø 80 mm	2 x USB (typ A + C) 5V DC / 2,4 A	○	●	• 1,8 m	czarny black	Ø 90 / 81
OR-GM-9015(GS)/W	5908254810794	1 x 2P+Z (max. 3680W)	Ø 80 mm	2 x USB (typ A + C) 5V DC / 2,4 A	○	●	• 1,8 m	biały white	Ø 90 / 81

Dostępne gniazda oraz porty modułowe

Socket modules and ports available

Symbol Product no.	EAN	Rodzaj gniazda Type of socket	Kolor Color	szer./wys./ gł. [mm] width x height x depth [mm]
OR-GM-9011/B/RJ45	5900378656128	Gniazdo sieciowe RJ45 Network socket RJ45	czarny black	22,8 / 47 / 19,8
OR-GM-9011/W/RJ45	5900378656111	Gniazdo sieciowe RJ45 Network socket RJ45	biały white	22,8 / 47 / 19,8
OR-GM-9011/B/HDMI	5900378656142	Gniazdo HDMI HDMI socket	czarny black	22,8 / 47 / 19,8
OR-GM-9011/W/HDMI	5900378656135	Gniazdo HDMI HDMI socket	biały white	22,8 / 47 / 19,8
OR-GM-9011/B/USB	5900378656166	USB DATA USB DATA	czarny black	22,8 / 47 / 19,8
OR-GM-9011/W/USB	5900378656159	USB DATA USB DATA	biały white	22,8 / 47 / 19,8



Dostępne funkcje:

AVAILABLE FUNCTIONS



Materiał: tworzywo sztuczne
Material: plastic



Ładowarka USB
USB charger



Montaż: zacisk śrubowy
Installation: clamp holder



OR-AE-13197/B
OR-AE-13133(GS)/B



OR-AE-13197/W
OR-AE-13133(GS)/W

Warianty produktu:

AVAILABLE VARIANTS

Symbol Product no.	EAN	Ilość gniazd sieciowych Number of sockets	Wersja french French type	Wersja Schuko Schuko type	Ładowarka USB USB charger	Kabel zasilający Power cable	Kolor Color	szer./wys./gł. [mm] width x height x depth [mm]
OR-AE-13197/W	5900378653110	2 x 2P+Z (max. 2300W)	●	○	● 2 x USB 5V DC / 2,4A	● 1,4 m (3x1,0mm ²)	biały white	164 / 67 / 58
OR-AE-13197/B	5908254803628	2 x 2P+Z (max. 2300W)	●	○	● 2 x USB 5V DC / 2,4A	● 1,4 m (3x1,0mm ²)	czarny black	164 / 67 / 58
OR-AE-13133(GS)/W	5908254811012	2 x 2P+Z (max. 3680W)	○	●	● 2 x USB 5V DC / 2,4A	● 1,4 m (3x1,5mm ²)	biały white	164 / 67 / 58
OR-AE-13133(GS)/B	5908254800535	2 x 2P+Z (max. 3680W)	○	●	● 2 x USB 5V DC / 2,4A	● 1,4 m (3x1,5mm ²)	czarny black	164 / 67 / 58



OR-AE-1327



Materiał: tworzywo sztuczne + metal lakierowany
Material: plastic + painted metal

OR-AE-1328



Materiał: tworzywo sztuczne + metal lakierowany
Material: plastic + painted metal



Włącznik On / Off
On / Off button

Warianty produktu:

AVAILABLE VARIANTS

 Symbol Product no.	 EAN	 Ilość gniazd sieciowych Number of sockets	 Wersja french French type	 Ładowarka USB USB charger	 Kabel zasilający Power cable	 szer./wys./gt. [mm] width x height x depth [mm]
OR-AE-1327	5901752486201	1 x 2P+Z, french / 2 x 2P/II (Max. 3500W)	french typ E / typ euro		• 1,5 m	155 / 92 / 80
OR-AE-1328	5901752486195	1 x 2P+Z, french / 1 x 2P/II (Max. 3500W)	french typ E / typ euro	• 1 x USB 5V DC / 2,1A	• 1,5 m	155 / 92 / 80



Dostępne funkcje:

AVAILABLE FUNCTIONS



Materiał: stal nierdzewna (INOX)
Material: stainless steel (INOX)



Montaż: pion / poziom
Installation: vertical / horizontal

Prosty montaż

Zestaw czterech gniazd sieciowych z uziemieniem i przesłonami torów prądowych w obudowie ze stali nierdzewnej INOX. Idealny do montażu w kuchni i biurze, na powierzchniach płaskich i w narożnikach za pomocą pasków samoprzylepnych z rzepami lub wkrętów. Zalecany przewód OWY 3 x 1,5 mm² (brak w zestawie).



Easy installation

A set of four power sockets with earthing and safety shutters, in a stainless steel (INOX) case. Designed for indoor installation on flat surfaces and in corners. It can be easily mounted using self-adhesive strips or traditionally – using screws. Recommended cable: OWY 3 x 1.5mm² (not included).

Warianty produktu:

AVAILABLE VARIANTS

Symbol Product no.	EAN	Ilość gniazd sieciowych Number of sockets	Wersja french French type	Wersja Schuko Schuko type	Kabel zasilający Power cable	szer./wys./gt. [mm] width x height x depth [mm]
OR-AE-1340	5901752487420	4 x 2P+Z (max. 3680W)	●	○		280 / 95 / 48
OR-AE-1340(GS)	5900378653899	4 x 2P+Z (max. 3680W)	○	●		280 / 95 / 48



Dostępne funkcje:

AVAILABLE FUNCTIONS



Materiał: tworzywo sztuczne + metal lakierowany
Material: plastic + painted metal



Ładowarka USB
USB charger



Montaż: pion / poziom
Installation: vertical / horizontal











OR-AE-1359

OR-AE-1360

Warianty produktu:

AVAILABLE VARIANTS

 Symbol Product no.	 EAN	 Ilość gniazd sieciowych Number of sockets	 Wersja french French type	 Wersja Schuko Schuko type	 Ładowarka USB USB charger	 Kabel zasilający Power cable	 szer./wys./gt. [mm] W/H/D [mm]
OR-AE-1359	5901752487697	3 x 2P+Z (max. 3680 W)	●	○		1,8 m	234 / 99,5 / 51,7
OR-AE-1359(GS)	5908254819940	3 x 2P+Z (max. 3680 W)	○	●		1,8 m	234 / 99,5 / 51,7
OR-AE-1360	5901752487703	3 x 2P+Z (max. 3680 W)	●	○	2 x USB 5V DC / 2,1A	1,8 m	276 / 99,5 / 56,5



Dostępne funkcje:

AVAILABLE FUNCTIONS



Materiał: tworzywo sztuczne + aluminium
Material: plastic + aluminium



Ładowarka USB
USB charger



Włącznik On / Off
On / Off button



Montaż: pion / poziom
Installation: vertical / horizontal

Warianty produktu:

AVAILABLE VARIANTS



OR-AE-1303/G
OR-AE-1303/G(GS)
OR-AE-1303/B



OR-AE-1310
OR-AE-1310(GS)













OR-AE-1302



OR-AE-1304
OR-AE-1304(GS)

Symbol Product no.	EAN	Ilość gniazd sieciowych Number of sockets	Wersja french French type	Wersja Schuko Schuko type	Ładowarka USB USB charger	Włącznik On/Off On/Off button	Kabel zasilający Power cable	Kolor Color	szer./wys./gl. [mm] width x height x depth [mm]
OR-AE-1303/G	5901752483415	2 x 2P+Z (max. 3680W)	●	○			● 0,5 m	srebrny silver	150 / 64 / 64
OR-AE-1303/G(GS)	5902560320749	2 x 2P+Z (max. 3680W)	○	●			● 0,5 m	srebrny silver	150 / 64 / 64
OR-AE-1303/B	5902560328516	2 x 2P+Z (max. 3680W)	●	○			● 0,5 m	czarny black	150 / 64 / 64
OR-AE-1310	5901752484047	1 x 2P+Z (max. 3680W)	●	○	● 2 x USB 5V DC / 2,1A		● 0,5 m	srebrny silver	150 / 64 / 64

 Symbol Product no.	 EAN	 Ilość gniazd sieciowych Number of sockets	 Wersja french French type	 Wersja Schuko Schuko type	 Ładowarka USB USB charger	 Wyłącznik On/Off On/Off button	 Kabel zasilający Power cable	 Kolor Color	 szer./wys./gl. [mm] width x height x depth [mm]
OR-AE-1310(GS)	5902560325911	1 x 2P+Z (max. 3680W)	○	●	2 x USB 5V DC / 2,1A	○	0,5 m	srebrny silver	150 / 64 / 64
OR-AE-1302	5901752483422	1 x 2P+Z (max. 3680W)	●	○		●	0,5 m	srebrny silver	150 / 64 / 64
OR-AE-1304	5901752483514	2 x 2P+Z (max. 3680W)	●	○		●	0,5 m	srebrny silver	275 / 64 / 64
OR-AE-1304(GS)	5902560322248	2 x 2P+Z (max. 3680W)	○	●		●	0,5 m	srebrny silver	275 / 64 / 64



OR-GM-9005/W-G
OR-GM-9005/W-G(GS)









OR-GM-9001/B-G
OR-GM-9001/B-G(GS)
OR-GM-9001/W-G
OR-GM-9001/W-G(GS)



OR-GM-9003/W-G
OR-GM-9003/W-G(GS)



OR-GM-9002/B-G
OR-GM-9002/B-G(GS)
OR-GM-9002/W-G
OR-GM-9002/W-G(GS)

 Symbol Product no.	 EAN	 Ilość gniazd sieciowych Number of sockets	 Wersja french French type	 Wersja Schuko Schuko type	 Ładowarka USB USB charger	 Wyłącznik On/Off On/Off button	 Kabel zasilający Power cable	 Kolor Color	 szer./wys./gl. [mm] w x h x d [mm]
OR-GM-9005/W-G	5902560329759	2 x 2P+Z (max. 3680W)	●	○		○	0,6 m	biały white	150 / 64 / 64
OR-GM-9005/W-G(GS)	5902560329742	2 x 2P+Z (max. 3680W)	○	●		○	0,6 m	biały white	150 / 64 / 64
OR-GM-9001/B-G	5902560329766	3 x 2P+Z (max. 3680W)	●	○		○	0,6 m	czarny black	200 / 64 / 64
OR-GM-9001/B-G(GS)	5902560329773	3 x 2P+Z (max. 3680W)	○	●		○	0,6 m	czarny black	200 / 64 / 64
OR-GM-9001/W-G	5902560329780	3 x 2P+Z (max. 3680W)	●	○		○	0,6 m	biały white	200 / 64 / 64
OR-GM-9001/W-G(GS)	5902560329797	3 x 2P+Z (max. 3680W)	○	●		○	0,6 m	biały white	200 / 64 / 64
OR-GM-9003/W-G	5902560329841	2 x 2P+Z (max. 3680W)	●	○	2 x USB 5V DC / 2,1A	○	0,6 m	biały white	198 / 64 / 64
OR-GM-9003/W-G(GS)	5902560329858	2 x 2P+Z (max. 3680W)	○	●	2 x USB 5V DC / 2,1A	○	0,6 m	biały white	198 / 64 / 64
OR-GM-9002/B-G	5902560329803	2 x 2P+Z (max. 3680W)	●	○		●	0,6 m	czarny black	210 / 64 / 64
OR-GM-9002/B-G(GS)	5902560329810	2 x 2P+Z (max. 3680W)	○	●		●	0,6 m	czarny black	210 / 64 / 64
OR-GM-9002/W-G	5902560329827	2 x 2P+Z (max. 3680W)	●	○		●	0,6 m	biały white	210 / 64 / 64
OR-GM-9002/W-G(GS)	5902560329834	2 x 2P+Z (max. 3680W)	○	●		●	0,6 m	biały white	210 / 64 / 64



Techniki łączeniowe

CONNECTION TECHNIQUE

Konektory kablowe CABLE CONNECTORS	254
Konektory fotowoltaiczne PHOTOVOLTAIC CONNECTORS	256
Szybkozłączki SPLICING CONNECTORS	257
Puszki żelowe GEL BOXES	259
Końcówki kablowe CABLE LUGS	260

Konektory kablowe

CABLE CONNECTORS

Główne cechy / Main features







Materiał obudowy: PoliAmid 6
Body material: PoliAmid 6





Obudowa uniepalniająca
Flame retardant body



Możliwość montażu w gruncie
Underground installation

					
Symbol Product no	OR-AE-13614/2	OR-AE-13600	OR-AE-13601	OR-AE-13602	OR-AE-13615
EAN	5908254821035	5908254802089	5908254802096	5908254802102	5908254821042
Typ konektora Connector type	MICRO prosty straight	MINI prosty straight	NORMAL prosty straight	T trójnik splitter	X czwórnik 4-way
Ilość przewodów Number of wires	2	3	3	3	3
Średnica kabla Wire gauge	3-6,5 mm	4-8 mm	6-12 mm	6-12 mm	6-12 mm
Przekrój żyły Wire cross-section	1,5 mm ²	1,5 mm ²	4 mm ²	4 mm ²	4 mm ²
Napięcie znamionowe Rated voltage	450V	450V	450V	450V	450V
Prąd Current	16A	16A	25A	25A	25A
Materiał styków Contact material	mosiądz niklowany nickel plated brass	mosiądz niklowany nickel plated brass	mosiądz niklowany nickel plated brass	mosiądz niklowany nickel plated brass	mosiądz niklowany nickel plated brass
Klasa palności obudowy UL94 Body fire rating UL94	V1	V1	V1	V1	V1
Odporność na promieniowanie UV UV-resistance	tak yes	tak yes	tak yes	tak yes	tak yes
Stopień ochrony Protection rating	IP68	IP68	IP68	IP68	IP68
Wymiary (szer./wys./gł. [mm]) Dimensions (w / h / d [mm])	57 / Ø 16	76 / Ø 20	89 / Ø 24	104 / 78 / Ø 24	100 / 100 / Ø 24
Rodzaj połączenia Type of connection	śrubowy screw	śrubowy screw	śrubowy screw	śrubowy screw	śrubowy screw









				
OR-AE-13603	OR-AE-13604	OR-AE-13612/10	OR-AE-13613/10	OR-AE-13612/K/10
5908254802119	5908254802126	5908254813221	5908254813238	5908254813245
M25 prosty straight	M25 prosty straight	plug-in	plug-in	klucz do konektora connector key
3	5	3	5	-
10-16 mm	10-16 mm	6-12 mm	6-12 mm	-
6 mm ²	6 mm ²	4 mm ²	4 mm ²	-
450V	450V	450V	450V	-
30A	30A	24A	24A	-
mosiądz niklowany nickel plated brass	mosiądz niklowany nickel plated brass	mosiądz cynowany tinned brass	mosiądz cynowany tinned brass	-
V1	V1	V2	V2	-
tak yes	tak yes	tak yes	tak yes	-
IP68	IP68	IP68	IP68	-
118 / Ø 30	118 / Ø 30	93 / Ø 26	93 / Ø 26	-
śrubowy screw	śrubowy screw	śrubowy screw	śrubowy screw	-



Konektory fotowoltaiczne

PHOTOVOLTAIC CONNECTORS

							
Symbol Product no	OR-PV-13605	OR-PV-13606	OR-PV-13607	OR-PV-13608	OR-PV-13609	OR-PV-13610	OR-PV-13611
EAN	5908254804335	5908254804342	5908254804359	5908254804366	5908254804373	5908254804380	5908254804397
Typ konektora Connector type	MC4	2xMC4, Typ Y	3xMC4, Typ Y	4xMC4, Typ Y	2xMC4, Typ T	3xMC4, Typ T	4xMC4, Typ T
Ilość przewodów Number of wires	1 x 1,5-6mm ²	2 x 1,5-6mm ²	3 x 1,5-6mm ²	4 x 1,5-6mm ²	2 x 1,5-6mm ²	3 x 1,5-6mm ²	4 x 1,5-6mm ²
Napięcie znamionowe Rated voltage	1000VDC	1000VDC	1000VDC	1000VDC	1000VDC	1000VDC	1000VDC
Prąd [A] Current [A]	30A	30A	30A	30A	30A	30A	30A
Materiał styków Contact material	miedź cynowana tinned copper	miedź cynowana tinned copper	miedź cynowana tinned copper	miedź cynowana tinned copper	miedź cynowana tinned copper	miedź cynowana tinned copper	miedź cynowana tinned copper
Materiał obudowy Body material	PC/PPO	PC/PA	PC/PA	PC/PA	PPO	PPO	PPO
Klasa palności obudowy UL94 Body fire rating UL94	V0	V0	V0	V0	V0	V0	V0
Oporność na promieniowanie UV UV-resistance	✓	✓	✓	✓	✓	✓	✓
Stopień ochrony Protection rating	IP67	IP67	IP67	IP67	IP67	IP67	IP67
Zgodność z normą Compliance with standards	IEC 60068-2-52	IEC 60068-2-52	IEC 60068-2-52	IEC 60068-2-52	IEC 60068-2-52	IEC 60068-2-52	IEC 60068-2-52
Zakres temperatury zewnętrznej [°C] Outdoor temperature range [°C]	-130	-130	-130	-130	-125	-125	-125
Maksymalna temperatura styku [°C] Max. temp. of the contact [°C]	105	105	105	105	105	105	105
Napięcie izolacji [kV] Insulation voltage	6	6	6	6	6	6	6
Rezystancja styku [mOhm] Contact resistance	0.5	0.5	0.5	0.5	0.5	0.5	0.5
Wymiary (szer./wys./gł. [mm]) Dimensions (w / h / d [mm])	300 / Ø 18	300 / Ø 18	300 / Ø 18	515 / Ø 18	107 / 41 / 18	107 / 63 / 18	107 / 85 / 18
Waga [g] Weight [g]	26	118.5	176	295.5	106.5	144	181
Rodzaj połączenia Type of connection	zaciskowe crimp	zaciskowe crimp	zaciskowe crimp	zaciskowe crimp	zaciskowe crimp	zaciskowe crimp	zaciskowe crimp



SZYBKOZŁĄCZKI

SPLICING CONNECTORS



Główne cechy / Main features

Klasa palności obudowy: UL94 V0
Body fire rating: UL94 V0















Materiał styków: miedź (100%) cynowana
Contact material: tinned copper (100%)



Materiał sprężyny: stal nierdzewna
Spring material: stainless steel



	Symbol Product no	EAN	Ilość Quantity	Zawartość zestawu Elements of the set	Materiał pudełka Box material	Wymiary pudełka [mm] Box dimensions [mm]
	OR-SZ-8006	5900378659396	65 szt. (pcs)	Wciskane (push-in): 2x0,75-2,5mm ² x 15pcs; 3x0,75-2,5mm ² x 15pcs; 4x0,75-2,5mm ² x 10pcs Zaciskowe (clamp): 2x0,2-4mm ² x 10pcs; 3x0,2-4mm ² x 15pcs	tworzywo sztuczne plastic	90 / 180 / 35
	OR-SZ-8007	5900378659402	123 szt. (pcs)	Wciskane (push-in): 2x0,75-2,5mm ² x 30pcs; 3x0,75-2,5mm ² x 30pcs; 4x0,75-2,5mm ² x 25pcs; 5x0,75-2,5mm ² x 20pcs; 6x0,75-2,5mm ² x 10pcs; 8x0,75-2,5mm ² x 8pcs	tworzywo sztuczne plastic	150 / 200 / 35
	OR-SZ-8009	5908254804786	109 szt. (pcs)	Wciskane (push-in): 2x0,75-2,5mm ² x 30pcs; 3x0,75-2,5mm ² x 30pcs; 5x0,75-2,5mm ² x 12pcs Zaciskowe (clamp): 2x0,2-4mm ² x 20pcs; 3x0,2-4mm ² x 12pcs; 5x0,2-4mm ² x 5pcs	tworzywo sztuczne plastic	150 / 200 / 35
	OR-SZ-8008	5900378659419	151 szt. (pcs)	Wciskane (push-in): 2x0,75-2,5mm ² x 25pcs; 3x0,75-2,5mm ² x 25pcs; 4x0,75-2,5mm ² x 20pcs; 5x0,75-2,5mm ² x 15pcs; 6x0,75-2,5mm ² x 10pcs; 8x0,75-2,5mm ² x 8pcs Zaciskowe (clamp): 2x0,2-4mm ² x 20pcs; 3x0,2-4mm ² x 20pcs; 5x0,2-4mm ² x 8pcs	tworzywo sztuczne plastic	195 / 290 / 35

	Symbol Product no	EAN	Montaż Installation	Ilość przewodów Number of wires	Napięcie zasilania Power supply	Prąd Current	Materiał obudowy Body material	Wymiary (szer./wys./gł. [mm]) Dimensions (W / H / D [mm])	Ilość Quantity
	OR-SZ-8010/2/10	5908254810862	zaciskowa clamp	2 x (0,75 - 2,5 mm ²)	250V~	5A	PP	17 / 13 / 20	10 szt. (pcs)
	OR-SZ-8010/2/100	5908254810879	zaciskowa clamp	2 x (0,75 - 2,5 mm ²)	250V~	5A	PP	17 / 13 / 20	100 szt. (pcs)
	OR-SZ-8010/3/10	5908254810886	zaciskowa clamp	3 x (0,75 - 2,5 mm ²)	250V~	5A	PP	27 / 13 / 20	10 szt. (pcs)
	OR-SZ-8010/3/100	5908254810893	zaciskowa clamp	3 x (0,75 - 2,5 mm ²)	250V~	5A	PP	27 / 13 / 20	100 szt. (pcs)
	OR-SZ-8014/10	5908254820823	zaciskowa clamp	1 x (0,75 - 2,5 mm ²)	400V~	24A	PA	9 / 15 / 20	10 szt. (pcs)
	OR-SZ-8014/100	5908254820809	zaciskowa clamp	1 x (0,75 - 2,5 mm ²)	400V~	24A	PA	9 / 15 / 20	100 szt. (pcs)
	OR-SZ-8015/10	5908254820830	wciskana/zaciskowa push-in/Clamp	2 x (0,75 - 2,5 mm ²)	400V~	24A	PA	9 / 15 / 20	10 szt. (pcs)
	OR-SZ-8015/100	5908254820816	wciskana/zaciskowa push-in/Clamp	2 x (0,75 - 2,5 mm ²)	400V~	24A	PA	9 / 15 / 20	100 szt. (pcs)
	OR-SZ-8004/2/10	5900378654919	wciskana push-in	2 x (0,75 - 2,5 mm ²)	300V~	24A	PC + PA66	12 / 7 / 16	10 szt. (pcs)
	OR-SZ-8004/2/B10	5908254809408	wciskana push-in	2 x (0,75 - 2,5 mm ²)	300V~	24A	PC + PA66	12 / 7 / 16	10 szt. (pcs) blister
	OR-SZ-8004/2/100	5900378655008	wciskana push-in	2 x (0,75 - 2,5 mm ²)	300V~	24A	PC + PA66	12 / 7 / 16	100 szt. (pcs)
	OR-SZ-8004/3/10	5900378654926	wciskana push-in	3 x (0,75 - 2,5 mm ²)	300V~	24A	PC + PA66	16 / 7 / 16	10 szt. (pcs)
	OR-SZ-8004/3/B10	5908254809415	wciskana push-in	3 x (0,75 - 2,5 mm ²)	300V~	24A	PC + PA66	16 / 7 / 16	10 szt. (pcs) blister
	OR-SZ-8004/3/100	5900378655015	wciskana push-in	3 x (0,75 - 2,5 mm ²)	300V~	24A	PC + PA66	16 / 7 / 16	100 szt. (pcs)
	OR-SZ-8004/4/10	5900378654933	wciskana push-in	4 x (0,75 - 2,5 mm ²)	300V~	24A	PC + PA66	12 / 11 / 16	10 szt. (pcs)
	OR-SZ-8004/4/B10	5908254809422	wciskana push-in	4 x (0,75 - 2,5 mm ²)	300V~	24A	PC + PA66	12 / 11 / 16	10 szt. (pcs) blister
	OR-SZ-8004/4/100	5900378655022	wciskana push-in	4 x (0,75 - 2,5 mm ²)	300V~	24A	PC + PA66	12 / 11 / 16	100 szt. (pcs)
	OR-SZ-8004/5/10	5900378654940	wciskana push-in	5 x (0,75 - 2,5 mm ²)	300V~	24A	PC + PA66	24 / 7 / 16	10 szt. (pcs)
	OR-SZ-8004/5/B10	5908254809439	wciskana push-in	5 x (0,75 - 2,5 mm ²)	300V~	24A	PC + PA66	24 / 7 / 16	10 szt. (pcs) blister
	OR-SZ-8004/5/50	5900378655039	wciskana push-in	5 x (0,75 - 2,5 mm ²)	300V~	24A	PC + PA66	24 / 7 / 16	50 szt. (pcs)
	OR-SZ-8004/6/10	5900378654957	wciskana push-in	6 x (0,75 - 2,5 mm ²)	300V~	24A	PC + PA66	16 / 11 / 16	10 szt. (pcs)
	OR-SZ-8004/6/B10	5908254809446	wciskana push-in	6 x (0,75 - 2,5 mm ²)	300V~	24A	PC + PA66	16 / 11 / 16	10 szt. (pcs) blister
	OR-SZ-8004/6/50	5900378655046	wciskana push-in	6 x (0,75 - 2,5 mm ²)	300V~	24A	PC + PA66	16 / 11 / 16	50 szt. (pcs)
	OR-SZ-8004/8/10	5900378654964	wciskana push-in	8 x (0,75 - 2,5 mm ²)	300V~	24A	PC + PA66	20 / 11 / 16	10 szt. (pcs)
	OR-SZ-8004/8/B8	5908254809453	wciskana push-in	8 x (0,75 - 2,5 mm ²)	300V~	24A	PC + PA66	20 / 11 / 16	10 szt. (pcs) blister
	OR-SZ-8004/8/50	5900378655053	wciskana push-in	8 x (0,75 - 2,5 mm ²)	300V~	24A	PC + PA66	20 / 11 / 16	50 szt. (pcs)
	OR-SZ-8005/2/10	5900378654971	zaciskowa clamp	2 x (0,2 - 4 mm ²)	450V~	32A	PC + PA66 GF16	15 / 11 / 21	10 szt. (pcs)
	OR-SZ-8005/2/B10	5908254809378	zaciskowa clamp	2 x (0,2 - 4 mm ²)	450V~	32A	PC + PA66 GF16	15 / 11 / 21	10 szt. (pcs) blister
	OR-SZ-8005/2/100	5900378655060	zaciskowa clamp	2 x (0,2 - 4 mm ²)	450V~	32A	PC + PA66 GF16	15 / 11 / 21	100 szt. (pcs)
	OR-SZ-8005/3/10	5900378654988	zaciskowa clamp	3 x (0,2 - 4 mm ²)	450V~	32A	PC + PA66 GF16	21 / 11 / 21	10 szt. (pcs)
	OR-SZ-8005/3/B6	5908254809385	zaciskowa clamp	3 x (0,2 - 4 mm ²)	450V~	32A	PC + PA66 GF16	21 / 11 / 21	10 szt. (pcs) blister
	OR-SZ-8005/3/100	5900378655077	zaciskowa clamp	3 x (0,2 - 4 mm ²)	450V~	32A	PC + PA66 GF16	21 / 11 / 21	100 szt. (pcs)
	OR-SZ-8005/5/10	5900378654995	zaciskowa clamp	5 x (0,2 - 4 mm ²)	450V~	32A	PC + PA66 GF16	33 / 11 / 21	10 szt. (pcs)
	OR-SZ-8005/5/B4	5908254809392	zaciskowa clamp	5 x (0,2 - 4 mm ²)	450V~	32A	PC + PA66 GF16	33 / 11 / 21	10 szt. (pcs) blister
	OR-SZ-8005/5/50	5900378655084	zaciskowa clamp	5 x (0,2 - 4 mm ²)	450V~	32A	PC + PA66 GF16	33 / 11 / 21	50 szt. (pcs)



PUSZKI ŻELOWE

GEL BOXES

Główne cechy / Main features

Klasa palności obudowy: UL94 HB
Body fire rating: UL94 HB



Stopień ochrony: IPX8
Protection rating: IPX8



Odporność na promieniowanie UV
UV-resistance



Możliwość montażu w gruncie
Underground installation



Wielokrotnego użytku
Reusable



OR-SZ-8016/B4



OR-SZ-8011/B2









OR-SZ-8012/B1

Symbol Product no	EAN	Temperatura pracy Operating temperature	Temperatura otoczenia Ambient temperature	Materiał Material	Spełniane normy Compliance with standards	Wymiary (szer./wys./gł. [mm]) Dimensions (W / H / D [mm])	Ilość Quantity
OR-SZ-8016/B4	5908254820847	90 °C	-40/+50 °C	PA	EN 50393	41 / 28 / 19	4 szt. (pcs)
OR-SZ-8011/B2	5908254813269	90 °C	-40/+50 °C	PA	EN 50393	45 / 37 / 24	2 szt. (pcs)
OR-SZ-8012/B1	5908254813276	90 °C	-40/+50 °C	PA	EN 50393	53 / 39 / 25	1 szt. (pc)









KOŃCÓWKI KABLOWE

CABLE LUGS

Tulejki izolowane podwójne / Insulated cable twin end terminals

	Symbol Product no	EAN	Przekrój żyły Wire cross-section	Materiał styków Conductor material	Materiał izolacji Insulation material	Długość [mm] Length [mm]	Grubość materiału przewodzącego [mm] Conductor thickness [mm]	Zgodność z normą Compliance with standard	Ilość Quantity
	OR-KK-8101/0,7/8/B2	5908254809606	0.75mm ²	Miedź(100%) Cynowana Tinned copper(100%)	PP	8	0.2	EN 60352-2:2006	25 szt. (pcs) blister
	OR-KK-8101/0,7/8	5908254808043	0.75mm ²	Miedź(100%) Cynowana Tinned copper(100%)	PP	8	0.2	EN 60352-2:2006	100 szt. (pcs)
	OR-KK-8101/1/8/B2	5908254809613	1mm ²	Miedź(100%) Cynowana Tinned copper(100%)	PP	8	0.2	EN 60352-2:2006	25 szt. (pcs) blister
	OR-KK-8101/1/8	5908254808050	1mm ²	Miedź(100%) Cynowana Tinned copper(100%)	PP	8	0.2	EN 60352-2:2006	100 szt. (pcs)
	OR-KK-8101/1/10/B2	5908254809620	1mm ²	Miedź(100%) Cynowana Tinned copper(100%)	PP	10	0.2	EN 60352-2:2006	25 szt. (pcs) blister
	OR-KK-8101/1/10	5908254808067	1mm ²	Miedź(100%) Cynowana Tinned copper(100%)	PP	10	0.2	EN 60352-2:2006	100 szt. (pcs)
	OR-KK-8101/1,5/8/B2	5908254809637	1.5mm ²	Miedź(100%) Cynowana Tinned copper(100%)	PP	8	0.2	EN 60352-2:2006	25 szt. (pcs) blister
	OR-KK-8101/1,5/8	5908254808074	1.5mm ²	Miedź(100%) Cynowana Tinned copper(100%)	PP	8	0.2	EN 60352-2:2006	100 szt. (pcs)
	OR-KK-8101/1,5/10/B2	5908254809644	1.5mm ²	Miedź(100%) Cynowana Tinned copper(100%)	PP	10	0.2	EN 60352-2:2006	25 szt. (pcs) blister
	OR-KK-8101/1,5/10	5908254808081	1.5mm ²	Miedź(100%) Cynowana Tinned copper(100%)	PP	10	0.2	EN 60352-2:2006	100 szt. (pcs)
	OR-KK-8101/2,5/10/B2	5908254809651	2.5mm ²	Miedź(100%) Cynowana Tinned copper(100%)	PP	10	0.2	EN 60352-2:2006	25 szt. (pcs) blister
	OR-KK-8101/2,5/10	5908254808098	2.5mm ²	Miedź(100%) Cynowana Tinned copper(100%)	PP	10	0.2	EN 60352-2:2006	100 szt. (pcs)
	OR-KK-8101/4/12/B2	5908254809668	4mm ²	Miedź(100%) Cynowana Tinned copper(100%)	PP	12	0.2	EN 60352-2:2006	25 szt. (pcs) blister
	OR-KK-8101/4/12	5908254808104	4mm ²	Miedź(100%) Cynowana Tinned copper(100%)	PP	12	0.2	EN 60352-2:2006	100 szt. (pcs)
	OR-KK-8101/6/14/B2	5908254809675	6mm ²	Miedź(100%) Cynowana Tinned copper(100%)	PP	14	0.2	EN 60352-2:2006	25 szt. (pcs) blister
	OR-KK-8101/6/14	5908254808111	6mm ²	Miedź(100%) Cynowana Tinned copper(100%)	PP	14	0.2	EN 60352-2:2006	100 szt. (pcs)

Tulejki izolowane / Insulated cable end terminals

	Symbol Product no	EAN	Przekrój żyły Wire cross-section	Materiał styków Conductor material	Materiał izolacji Insulation material	Długość [mm] Length [mm]	Grubość materiału przewodzącego[mm] Conductor thickness [mm]	Zgodność z normą Compliance with standard	Ilość Quantity
	OR-KK-8100/0,5/8/B2	5908254809460	0.5mm ²	Miedź(100%) Cynowana Tinned copper(100%)	PP	8	0.2	EN 60352-2:2006	25 szt. (pcs) blister
	OR-KK-8100/0,5/8	5908254807909	0.5mm ²	Miedź(100%) Cynowana Tinned copper(100%)	PP	8	0.2	EN 60352-2:2006	100 szt. (pcs)
	OR-KK-8100/0,7/10/B2	5908254809484	0.75mm ²	Miedź(100%) Cynowana Tinned copper(100%)	PP	10	0.2	EN 60352-2:2006	25 szt. (pcs) blister
	OR-KK-8100/0,7/10	5908254807923	0.75mm ²	Miedź(100%) Cynowana Tinned copper(100%)	PP	10	0.2	EN 60352-2:2006	100 szt. (pcs)
	OR-KK-8100/0,7/8/B2	5908254809477	0.75mm ²	Miedź(100%) Cynowana Tinned copper(100%)	PP	8	0.2	EN 60352-2:2006	25 szt. (pcs) blister
	OR-KK-8100/0,7/8	5908254807916	0.75mm ²	Miedź(100%) Cynowana Tinned copper(100%)	PP	8	0.2	EN 60352-2:2006	100 szt. (pcs)
	OR-KK-8100/1/8/B2	5908254809491	1mm ²	Miedź(100%) Cynowana Tinned copper(100%)	PP	8	0.2	EN 60352-2:2006	25 szt. (pcs) blister
	OR-KK-8100/1/8	5908254807930	1mm ²	Miedź(100%) Cynowana Tinned copper(100%)	PP	8	0.2	EN 60352-2:2006	100 szt. (pcs)
	OR-KK-8100/1/10/B2	5908254809507	1mm ²	Miedź(100%) Cynowana Tinned copper(100%)	PP	10	0.2	EN 60352-2:2006	25 szt. (pcs) blister
	OR-KK-8100/1/10	5908254807947	1mm ²	Miedź(100%) Cynowana Tinned copper(100%)	PP	10	0.2	EN 60352-2:2006	100 szt. (pcs)
	OR-KK-8100/1,5/8/B2	5908254809514	1.5mm ²	Miedź(100%) Cynowana Tinned copper(100%)	PP	8	0.2	EN 60352-2:2006	25 szt. (pcs) blister
	OR-KK-8100/1,5/8	5908254807954	1.5mm ²	Miedź(100%) Cynowana Tinned copper(100%)	PP	8	0.2	EN 60352-2:2006	100 szt. (pcs)
	OR-KK-8100/1,5/10/B2	5908254809521	1.5mm ²	Miedź(100%) Cynowana Tinned copper(100%)	PP	10	0.2	EN 60352-2:2006	25 szt. (pcs) blister
	OR-KK-8100/1,5/10	5908254807961	1.5mm ²	Miedź(100%) Cynowana Tinned copper(100%)	PP	10	0.2	EN 60352-2:2006	100 szt. (pcs)
	OR-KK-8100/2,5/10/B2	5908254809545	2.5mm ²	Miedź(100%) Cynowana Tinned copper(100%)	PP	10	0.2	EN 60352-2:2006	25 szt. (pcs) blister
	OR-KK-8100/2,5/10	5908254807985	2.5mm ²	Miedź(100%) Cynowana Tinned copper(100%)	PP	10	0.2	EN 60352-2:2006	100 szt. (pcs)
	OR-KK-8100/2,5/8/B2	5908254809538	2.5mm ²	Miedź(100%) Cynowana Tinned copper(100%)	PP	8	0.2	EN 60352-2:2006	25 szt. (pcs) blister
	OR-KK-8100/2,5/8	5908254807978	2.5mm ²	Miedź(100%) Cynowana Tinned copper(100%)	PP	8	0.2	EN 60352-2:2006	100 szt. (pcs)
	OR-KK-8100/4/10/B2	5908254809552	4mm ²	Miedź(100%) Cynowana Tinned copper(100%)	PP	10	0.2	EN 60352-2:2006	25 szt. (pcs) blister
	OR-KK-8100/4/10	5908254807992	4mm ²	Miedź(100%) Cynowana Tinned copper(100%)	PP	10	0.2	EN 60352-2:2006	100 szt. (pcs)
	OR-KK-8100/6/10/B2	5908254809569	6mm ²	Miedź(100%) Cynowana Tinned copper(100%)	PP	10	0.2	EN 60352-2:2006	25 szt. (pcs) blister
	OR-KK-8100/6/10	5908254808005	6mm ²	Miedź(100%) Cynowana Tinned copper(100%)	PP	10	0.2	EN 60352-2:2006	100 szt. (pcs)
	OR-KK-8100/6/12/B2	5908254809576	6mm ²	Miedź(100%) Cynowana Tinned copper(100%)	PP	12	0.2	EN 60352-2:2006	25 szt. (pcs) blister
	OR-KK-8100/6/12	5908254808012	6mm ²	Miedź(100%) Cynowana Tinned copper(100%)	PP	12	0.2	EN 60352-2:2006	100 szt. (pcs)
	OR-KK-8100/10/12/B2	5908254809583	10mm ²	Miedź(100%) Cynowana Tinned copper(100%)	PP	12	0.2	EN 60352-2:2006	25 szt. (pcs) blister
	OR-KK-8100/10/12	5908254808029	10mm ²	Miedź(100%) Cynowana Tinned copper(100%)	PP	12	0.2	EN 60352-2:2006	100 szt. (pcs)



Końcówki oczkowe izolowane / Insulated ring terminals

Symbol	EAN	Przekrój żyły	Materiał styków	Materiał izolacji	Rozmiar śruby metryczny	Grubość materiału przewodzącego [mm]	Zgodność z normą	Ilość
Product no		Wire cross-section	Conductor material	Insulation material	Screw metric size	Conductor thickness [mm]	Compliance with standards	Quantity
OR-KK-8102/1/4/B1	5908254809682	1mm ²	Miedź(100%) Cynowana Tinned copper(100%)	PVC	M4	0.7	EN 60352-2:2006	10 szt. (pcs) blister
OR-KK-8102/1/4/B2	5908254808210	1mm ²	Miedź(100%) Cynowana Tinned copper(100%)	PVC	M4	0.7	EN 60352-2:2006	25 szt. (pcs) blister
OR-KK-8102/1/4	5908254808128	1mm ²	Miedź(100%) Cynowana Tinned copper(100%)	PVC	M4	0.7	EN 60352-2:2006	100 szt. (pcs)
OR-KK-8102/1/6/B1	5908254809699	1mm ²	Miedź(100%) Cynowana Tinned copper(100%)	PVC	M6	0.7	EN 60352-2:2006	10 szt. (pcs) blister
OR-KK-8102/1/6/B2	5908254808227	1mm ²	Miedź(100%) Cynowana Tinned copper(100%)	PVC	M6	0.7	EN 60352-2:2006	25 szt. (pcs) blister
OR-KK-8102/1/6	5908254808135	1mm ²	Miedź(100%) Cynowana Tinned copper(100%)	PVC	M6	0.7	EN 60352-2:2006	100 szt. (pcs)
OR-KK-8102/2,5/4/B1	5908254809705	2.5mm ²	Miedź(100%) Cynowana Tinned copper(100%)	PVC	M4	0.7	EN 60352-2:2006	10 szt. (pcs) blister
OR-KK-8102/2,5/4/B2	5908254808234	2.5mm ²	Miedź(100%) Cynowana Tinned copper(100%)	PVC	M4	0.7	EN 60352-2:2006	25 szt. (pcs) blister
OR-KK-8102/2,5/4	5908254808142	2.5mm ²	Miedź(100%) Cynowana Tinned copper(100%)	PVC	M4	0.7	EN 60352-2:2006	100 szt. (pcs)
OR-KK-8102/2,5/5/B1	5908254809712	2.5mm ²	Miedź(100%) Cynowana Tinned copper(100%)	PVC	M5	0.7	EN 60352-2:2006	10 szt. (pcs) blister
OR-KK-8102/2,5/5/B2	5908254808241	2.5mm ²	Miedź(100%) Cynowana Tinned copper(100%)	PVC	M5	0.7	EN 60352-2:2006	25 szt. (pcs) blister
OR-KK-8102/2,5/5	5908254808159	2.5mm ²	Miedź(100%) Cynowana Tinned copper(100%)	PVC	M5	0.7	EN 60352-2:2006	100 szt. (pcs)
OR-KK-8102/2,5/6/B1	5908254809729	2.5mm ²	Miedź(100%) Cynowana Tinned copper(100%)	PVC	M6	0.7	EN 60352-2:2006	10 szt. (pcs) blister
OR-KK-8102/2,5/6/B2	5908254808258	2.5mm ²	Miedź(100%) Cynowana Tinned copper(100%)	PVC	M6	0.7	EN 60352-2:2006	25 szt. (pcs) blister
OR-KK-8102/2,5/6	5908254808166	2.5mm ²	Miedź(100%) Cynowana Tinned copper(100%)	PVC	M6	0.7	EN 60352-2:2006	100 szt. (pcs)
OR-KK-8102/2,5/8/B1	5908254809736	2.5mm ²	Miedź(100%) Cynowana Tinned copper(100%)	PVC	M8	0.7	EN 60352-2:2006	10 szt. (pcs) blister
OR-KK-8102/2,5/8/B2	5908254808265	2.5mm ²	Miedź(100%) Cynowana Tinned copper(100%)	PVC	M8	0.7	EN 60352-2:2006	25 szt. (pcs) blister
OR-KK-8102/2,5/8	5908254808173	2.5mm ²	Miedź(100%) Cynowana Tinned copper(100%)	PVC	M8	0.7	EN 60352-2:2006	100 szt. (pcs)
OR-KK-8102/6/4/B1	5908254809743	6mm ²	Miedź(100%) Cynowana Tinned copper(100%)	PVC	M4	0.8	EN 60352-2:2006	10 szt. (pcs) blister
OR-KK-8102/6/4/B2	5908254808272	6mm ²	Miedź(100%) Cynowana Tinned copper(100%)	PVC	M4	0.8	EN 60352-2:2006	25 szt. (pcs) blister
OR-KK-8102/6/4	5908254808180	6mm ²	Miedź(100%) Cynowana Tinned copper(100%)	PVC	M4	0.8	EN 60352-2:2006	100 szt. (pcs)
OR-KK-8102/6/6/B1	5908254809750	6mm ²	Miedź(100%) Cynowana Tinned copper(100%)	PVC	M6	0.8	EN 60352-2:2006	10 szt. (pcs) blister
OR-KK-8102/6/6/B2	5908254808289	6mm ²	Miedź(100%) Cynowana Tinned copper(100%)	PVC	M6	0.8	EN 60352-2:2006	25 szt. (pcs) blister
OR-KK-8102/6/6	5908254808197	6mm ²	Miedź(100%) Cynowana Tinned copper(100%)	PVC	M6	0.8	EN 60352-2:2006	100 szt. (pcs)
OR-KK-8102/6/8/B1	5908254809767	6mm ²	Miedź(100%) Cynowana Tinned copper(100%)	PVC	M8	0.8	EN 60352-2:2006	10 szt. (pcs) blister
OR-KK-8102/6/8/B2	5908254808296	6mm ²	Miedź(100%) Cynowana Tinned copper(100%)	PVC	M8	0.8	EN 60352-2:2006	25 szt. (pcs) blister
OR-KK-8102/6/8	5908254808203	6mm ²	Miedź(100%) Cynowana Tinned copper(100%)	PVC	M8	0.8	EN 60352-2:2006	100 szt. (pcs)



Końcówki oczkowe nieizolowane / Non-insulated ring terminals

OR-KK-8103/6/6/B1	5908254809774	6mm ²	Miedź(100%) Cynowana Tinned copper(100%)	-	M6	0.8	EN 60352-2:2006	10 szt. (pcs) blister
OR-KK-8103/10/8/B1	5908254809781	10mm ²	Miedź(100%) Cynowana Tinned copper(100%)	-	M8	1.2	EN 60352-2:2006	10 szt. (pcs) blister
OR-KK-8103/16/8/B1	5908254809798	16mm ²	Miedź(100%) Cynowana Tinned copper(100%)	-	M8	1.4	EN 60352-2:2006	10 szt. (pcs) blister



Końcówki widelkowe izolowane / Insulated spade terminals

	Symbol Product no	EAN	Przekrój żyły Wire cross-section	Materiał styków Contact material	Materiał izolacji Insulation material	Rozmiar śruby metryczny Screw metric size	Grubość materiału przewodzącego [mm] Conducting material thickness [mm]	Zgodność z normą Compliance with standards	Ilość Quantity
	OR-KK-8104/2,5/4/B1	5908254809811	2.5mm ²	Miedź(100%) Cynowana Tinned copper(100%)	PVC	M4	0,7	EN 60352-2:2006	10 szt. (pcs) blister
	OR-KK-8104/2,5/4/B2	5908254808302	2.5mm ²	Miedź(100%) Cynowana Tinned copper(100%)	PVC	M4	0,7	EN 60352-2:2006	25 szt. (pcs) blister
	OR-KK-8104/2,5/6/B1	5908254809828	2.5mm ²	Miedź(100%) Cynowana Tinned copper(100%)	PVC	M6	0,8	EN 60352-2:2006	10 szt. (pcs) blister
	OR-KK-8104/2,5/6/B2	5908254808319	2.5mm ²	Miedź(100%) Cynowana Tinned copper(100%)	PVC	M6	0,8	EN 60352-2:2006	25 szt. (pcs) blister
	OR-KK-8104/6/4/B1	5908254809842	6mm ²	Miedź(100%) Cynowana Tinned copper(100%)	PVC	M4	0,8	EN 60352-2:2006	10 szt. (pcs) blister
	OR-KK-8104/6/4/B2	5908254808326	6mm ²	Miedź(100%) Cynowana Tinned copper(100%)	PVC	M4	0,8	EN 60352-2:2006	25 szt. (pcs) blister
	OR-KK-8104/6/6/B1	5908254809835	6mm ²	Miedź(100%) Cynowana Tinned copper(100%)	PVC	M6	0,8	EN 60352-2:2006	10 szt. (pcs) blister
	OR-KK-8104/6/6/B2	5908254808333	6mm ²	Miedź(100%) Cynowana Tinned copper(100%)	PVC	M6	0,8	EN 60352-2:2006	25 szt. (pcs) blister

Konektory całkowicie izolowane / Fully insulated blade receptacle terminals

	Symbol Product no	EAN	Przekrój żyły Wire cross-section	Materiał styków Contact material	Materiał izolacji Insulation material	Szerokość konektora [mm] Connector width [mm]	Grubość materiału przewodzącego [mm] Conducting material thickness [mm]	Zgodność z normą Compliance with standards	Ilość Quantity
	OR-KK-8105/1/6/B1	5908254809859	0.5-1mm ²	Mosiądz, Cynowany Tinned brass	PVC	6.3	0,7	EN 60352-2:2006	10 szt. (pcs) blister
	OR-KK-8105/2,5/6/B1	5908254809866	1-2.5mm ²	Mosiądz, Cynowany Tinned brass	PVC	6.3	0,7	EN 60352-2:2006	10 szt. (pcs) blister

Wsuwki całkowicie izolowane / Insulated blade terminals

	OR-KK-8106/1/6/B1	5908254809897	0.5-1mm ²	Mosiądz, Cynowany Tinned brass	PVC	6.3	0,7	EN 60352-2:2006	10 szt. (pcs) blister
	OR-KK-8106/2,5/6/B1	5908254809903	1-2.5mm ²	Mosiądz, Cynowany Tinned brass	PVC	6.3	0,7	EN 60352-2:2006	10 szt. (pcs) blister



Konektory nieizolowane / Non-insulated blade receptacle terminals

	Symbol Product no	EAN	Przekrój żyty Wire cross-section	Materiał styków Contact material	Szerokość konektora [mm] Connector width [mm]	Grubość materiału przewodzącego [mm] Conducting material thickness [mm]	Zgodność z normą Compliance with standards	Ilość Quantity
	OR-KK-8107/1/6/B1	5908254809873	0.5-1mm ²	Mosiądz Brass	6.3	0,7	EN 60352-2:2006	10 szt. (pcs) blister
	OR-KK-8107/2,5/6/B1	5908254809880	1-2.5mm ²	Mosiądz Brass	6.3	0,7	EN 60352-2:2006	10 szt. (pcs) blister



Wsuwka nieizolowana / Non-insulated blade terminals







	OR-KK-8108/1/6/B1	5908254809910	0.5-1mm ²	Mosiądz Brass	6.3	0,7	EN 60352-2:2006	10 szt. (pcs) blister
	OR-KK-8108/2,5/6/B1	5908254809927	1-2.5mm ²	Mosiądz Brass	6.3	0,7	EN 60352-2:2006	10 szt. (pcs) blister

Mufki zaciskowe izolowane / Insulated butt joints

	Symbol Product no	EAN	Przekrój żyty Wire cross-section	Materiał styków Contact material	Materiał izolacji Insulation material	Długość końcówki [mm] Connector length [mm]	Grubość materiału przewodzącego [mm] Conducting material thickness [mm]	Zgodność z normą Compliance with standards	Ilość Quantity
	OR-KK-8109/1/B1	5908254809934	1mm ²	Miedź (100%) Cynowana Tinned copper (100%)	PVC	25	0,7	EN 60352-2:2006	10 szt. (pcs) blister
	OR-KK-8109/2,5/B1	5908254809941	2.5mm ²	Miedź (100%) Cynowana Tinned copper (100%)	PVC	25	0,7	EN 60352-2:2006	10 szt. (pcs) blister
	OR-KK-8109/6/B1	5908254809958	6mm ²	Miedź (100%) Cynowana Tinned copper (100%)	PVC	25	0,8	EN 60352-2:2006	10 szt. (pcs) blister

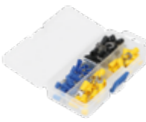
Mufki zaciskowe w izolacji termokurczliwej / Butt joints with heat shrink insulation

	Symbol Product no	EAN	Przekrój żyty Wire cross-section	Materiał styków Contact material	Materiał izolacji Insulation material	Grubość materiału przewodzącego [mm] Conducting material thickness [mm]	Zgodność z normą Compliance with standards	Ilość Quantity
	OR-KK-8110/1,5/B1	5908254809965	1.5mm ²	Miedź (100%) Cynowana Tinned copper (100%)	PE	0,4	EN 60352-2:2006	10 szt. (pcs) blister
	OR-KK-8110/2,5/B1	5908254809972	2.5mm ²	Miedź (100%) Cynowana Tinned copper (100%)	PE	0,7	EN 60352-2:2006	10 szt. (pcs) blister
	OR-KK-8110/6/B1	5908254809989	6mm ²	Miedź (100%) Cynowana Tinned copper (100%)	PE	1	EN 60352-2:2006	10 szt. (pcs) blister

	Symbol Product no	EAN	Ilość Quantity	Zawartość zestawu Elements of the set	Materiał pudełka Box material	Wymiary pudełka [mm] Box dimensions [mm]
	OR-AE-13137	5900378650096	400 szt. (pcs)	Tulejka izolowana (insulated end terminal): 0,5mm ² x 50pc; 0,75mm ² x 100pc; 1mm ² x 100pc; 1,5mm ² x 100pc; 2,5mm ² x 50pc	tworzywo sztuczne plastic	Ø95 / 41
	OR-KK-8111	5908254812767	350 szt. (pcs)	Tulejka izolowana (insulated end terminal): 0,75mm ² /10mm x 80pcs; 1mm ² /10mm x 70pcs; 1,5mm ² /10mm x 60pcs; 2,5mm ² /10mm x 50pcs Tulejka izolowana, podwójna (twin insulated end terminal): 0,75mm ² /8mm x 30pcs; 1mm ² /10mm x 25pcs; 1,5mm ² /10mm x 20pcs; 2,5mm ² /10mm x 15pcs	tworzywo sztuczne plastic	138 / 69 / 27
	OR-KK-8112	5908254812774	120 szt. (pcs)	Końcówki oczkowe izolowane (insulated ring terminals) 1mm ² xM4 x 25pcs; 2,5mm ² xM4 x 20pcs; 2,5mm ² xM5 x 20pcs; 2,5mm ² xM6 x 20pcs; 6mm ² xM6 x 20pcs; 6mm ² xM8 x 15pcs;	tworzywo sztuczne plastic	138 / 69 / 27
	OR-KK-8113	5908254812781	95 szt. (pcs)	Końcówki widelkowe izolowane (insulated spade terminals) 2,5mm ² xM4 x 30pcs; 2,5mm ² xM6 x 30pcs; 6mm ² xM4 x 20pcs; 6mm ² xM6 x 15pcs	tworzywo sztuczne plastic	138 / 69 / 27
	OR-KK-8114	5908254812798	125 szt. (pcs)	Konektory izolowane (insulated blade receptacle) 0,5-1mm ² /6,3mm x 20pcs; 1-2,5mm ² /6,3mm x 15pcs Wsuwki izolowane (insulated blade) 0,5-1mm ² /6,3mm x 20pcs; 1-2,5mm ² /6,3mm x 15pcs Banany izolowane (insulated bullet type) M 0,5-1mm ² /4mm x 15pcs; F 0,5-1mm ² /4mm x 15pcs Mufy izolowane (insulated butt joint) 1mm ² /25mm x 15pcs; 2,5mm ² /25mm x 10pcs	tworzywo sztuczne plastic	138 / 69 / 27
	OR-KK-8115	5908254821370	100 szt. (pcs)	Koszulki termokurczliwe z cyną (heat shrink soldering sleeve) 0,5mm ² x 25pcs; 1,5mm ² x 35pcs; 2,5mm ² x 30pcs; 4,0mm ² x 10pcs	tworzywo sztuczne plastic	138 / 69 / 27
	OR-AE-13136	5902560328301	100 szt. (pcs)	Konektory izolowane (insulated blade receptacle) 0,5-1mm ² x 10pcs; 1-2,5mm ² x 10pcs; 2,5-4mm ² x 10pcs Wsuwki izolowane (insulated blade) 0,5-1mm ² x 10pcs; 1-2,5mm ² x 10pcs Banany izolowane (insulated bullet type) M 1-2,5mm ² x 10pcs; F 1-2,5mm ² x 10pcs Konektory izolowane rozdzielcze (insulated blade receptacle splitter) 0,5-1mm ² x 10pcs; 1-2,5mm ² x 10pcs Końcówki oczkowe izolowane (insulated ring terminals) 0,5-1mm ² x 10pcs	tworzywo sztuczne plastic	212 / 60 / 13



Akcesoria elektroinstalacyjne

ELECTRICAL INSTALLATION ACCESSORIES

Puszki podtynkowe IN-WALL JUNCTION BOXES	268
Taśmy izolacyjne INSULATION TAPES	269
Opaski kablowe CABLE TIES	270
Koszulki termokurczliwe HEAT SHRINKABLE TUBES	272
Testery napięcia VOLTAGE TESTERS	273

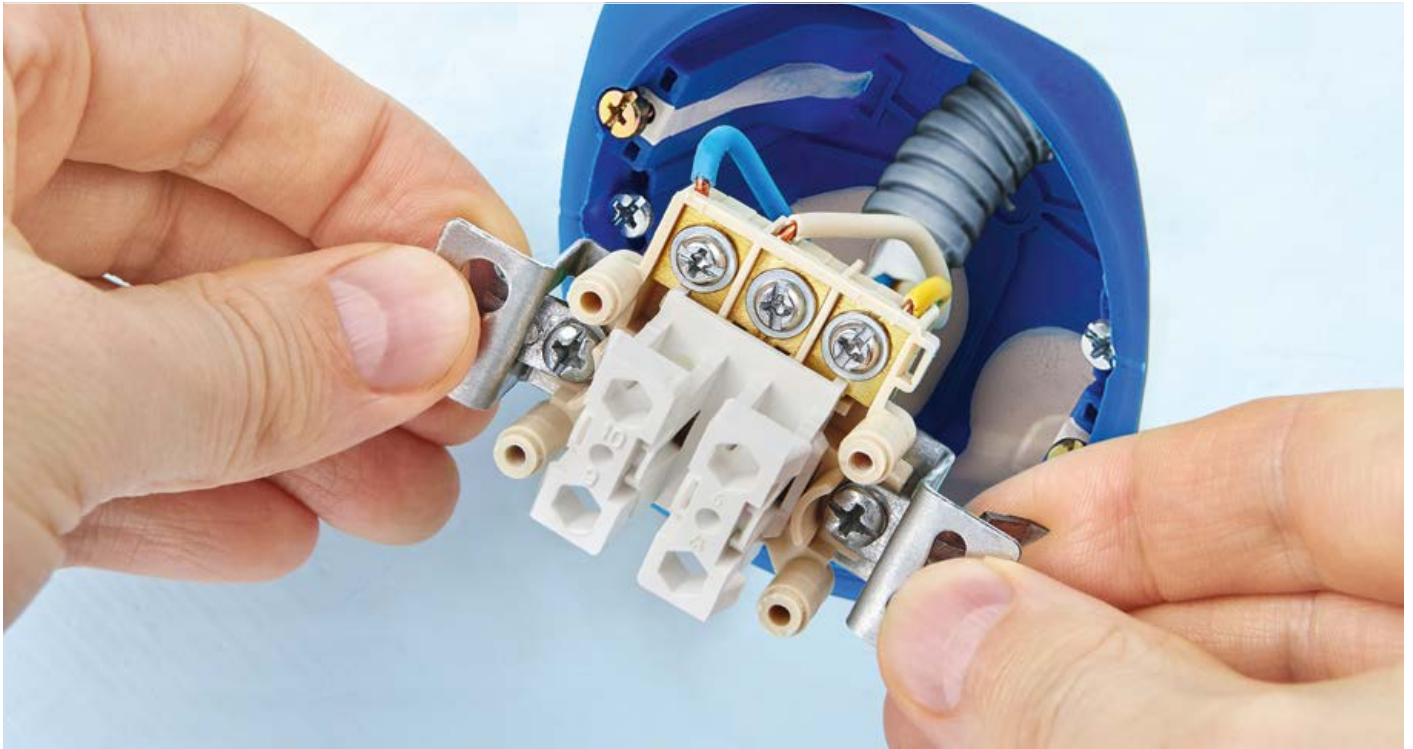

Puszki podtynkowe

IN-WALL JUNCTION BOXES



OR-JB-13800



OR-JB-13801

Główne cechy / Main features



Wiatroszczelność
Windproof

850°C

Badanie rozżarzonego drutu
Glow wire testing



Standard osprzętu: Ø60
Wiring accessories standard: Ø60



Puszka pogłębiana
Extended depth



Możliwość korekty osprzętu w poziomie
Wiring accessories levelling adjustment



Montaż w ścianach z gipsu kartonu
Drywall installation

Symbol Product no.	EAN	Materiał Material	Przepusty kablowe Cable glands	Wymiary (szer./wys./gł. [mm]) Dimensions (W/H/D [mm])
OR-JB-13800	5908254814693	PP	2xM16/20 2xM20/25	67 / 67 / 50
OR-JB-13801	5908254814709	PP	4xM16/20 4xM20/25	134 / 67 / 50

Taśmy izolacyjne

INSULATION TAPES



OR-AE-13215
OR-AE-13198



OR-AE-13214/YG/10M
OR-AE-13196/YG/20M

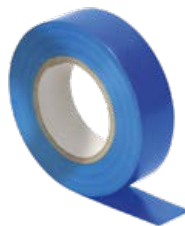

OR-AE-13214/BL/10M
OR-AE-13196/BL/20M



OR-AE-13214/BR/10M
OR-AE-13196/BR/20M



OR-AE-13214/B/10M
OR-AE-13196/B/20M

Symbol Product no.	EAN	Typ Type	Szerokość [mm] Width [mm]	Długość [m] Length [m]	Ilość sztuk Quantity	Kolor Color	Inne cechy: Other features
OR-AE-13214/B/10M	5908254807800	taśma izolacyjna insulation tape	15	10	1	czarny black	niepalny flame-retardant
OR-AE-13214/B/10M/S	5908254808401	taśma izolacyjna insulation tape	15	10	10	czarny black	niepalny flame-retardant
OR-AE-13214/BR/10M	5908254807817	taśma izolacyjna insulation tape	15	10	1	brązowy brown	niepalny flame-retardant
OR-AE-13214/BR/10M/S	5908254808418	taśma izolacyjna insulation tape	15	10	10	brązowy brown	niepalny flame-retardant
OR-AE-13214/BL/10M	5908254807824	taśma izolacyjna insulation tape	15	10	1	niebieski blue	niepalny flame-retardant
OR-AE-13214/BL/10M/S	5908254808425	taśma izolacyjna insulation tape	15	10	10	niebieski blue	niepalny flame-retardant
OR-AE-13214/YG/10M	5908254807831	taśma izolacyjna insulation tape	15	10	1	żółto-zielony yellow-green	niepalny flame-retardant
OR-AE-13214/YG/10M/S	5908254808432	taśma izolacyjna insulation tape	15	10	10	żółto-zielony yellow-green	niepalny flame-retardant
OR-AE-13215	5908254807893	podwójny zestaw taśm double set of insulation tapes	15	10	10	2x czarny, 1x brązowy, 1x niebieski, 1x żółto-zielony 2x black, 1x brown, 1x blue, 1x yellow-green	niepalny flame-retardant
OR-AE-13196/B/20M	5908254807848	taśma izolacyjna insulation tape	19	20	1	czarny black	niepalny flame-retardant
OR-AE-13196/B/20M/S	5908254809804	taśma izolacyjna insulation tape	19	20	10	czarny black	niepalny flame-retardant
OR-AE-13196/BR/20M	5908254807855	taśma izolacyjna insulation tape	19	20	1	brązowy brown	niepalny flame-retardant
OR-AE-13196/BR/20M/S	5908254803505	taśma izolacyjna insulation tape	19	20	10	brązowy brown	niepalny flame-retardant
OR-AE-13196/BL/20M	5908254807862	taśma izolacyjna insulation tape	19	20	1	niebieski blue	niepalny flame-retardant
OR-AE-13196/BL/20M/S	5908254803512	taśma izolacyjna insulation tape	19	20	10	niebieski blue	niepalny flame-retardant
OR-AE-13196/YG/20M	5908254807879	taśma izolacyjna insulation tape	19	20	1	żółto-zielony yellow-green	niepalny flame-retardant
OR-AE-13196/YG/20M/S	5908254803529	taśma izolacyjna insulation tape	19	20	10	żółto-zielony yellow-green	niepalny flame-retardant
OR-AE-13198	5908254807886	podwójny zestaw taśm double set of insulation tapes	19	20	10	2x czarny, 1x brązowy, 1x niebieski, 1x żółto-zielony 2x black, 1x brown, 1x blue, 1x yellow-green	niepalny flame-retardant

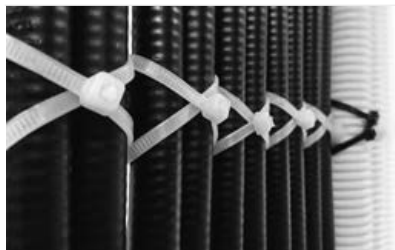

Opaski kablowe

CABLE TIES

Materiał: PA66
Material: PA66



Klasa palności UL94 V2
Fire rating UL94 V2



Symbol Product no.	EAN	Szerokość [mm] Width [mm]	Długość [mm] Length [mm]	Min. wytrzymałość na zerwanie [kg] Breaking strength	Odporność na promieniowanie UV UV proof	Kolor Color	Ilość sztuk Quantity
OR-AE-13199/3/10/25	5908254809064	2,5	100	8	○	naturalny / natural	25
OR-AE-13199/3/10/100	5908254808463	2,5	100	8	○	naturalny / natural	100
OR-AE-13199/3/15/25	5908254809071	2,5	150	8	○	naturalny / natural	25
OR-AE-13199/3/15/100	5908254808487	2,5	150	8	○	naturalny / natural	100
OR-AE-13199/3/20/25	5908254811920	2,5	200	8	○	naturalny / natural	25
OR-AE-13199/3/20/100	5908254808494	2,5	200	8	○	naturalny / natural	100
OR-AE-13199/4/15/25	5908254811937	3,6	150	18	○	naturalny / natural	25
OR-AE-13199/4/15/100	5908254808500	3,6	150	18	○	naturalny / natural	100
OR-AE-13199/4/20/25	5908254811944	3,6	200	18	○	naturalny / natural	25
OR-AE-13199/4/20/100	5908254808524	3,6	200	18	○	naturalny / natural	100
OR-AE-13199/4/30/25	5908254811951	3,6	300	18	○	naturalny / natural	25
OR-AE-13199/4/30/100	5908254808548	3,6	300	18	○	naturalny / natural	100
OR-AE-13199/5/20/25	5908254811968	4,8	200	22	○	naturalny / natural	25
OR-AE-13199/5/20/100	5908254808579	4,8	200	22	○	naturalny / natural	100
OR-AE-13199/5/25/25	5908254811975	4,8	250	22	○	250	25
OR-AE-13199/5/25/100	5908254808593	4,8	250	22	○	naturalny / natural	100
OR-AE-13199/5/30/25	5908254811982	4,8	300	22	○	naturalny / natural	25
OR-AE-13199/5/30/100	5908254808609	4,8	300	22	○	naturalny / natural	100
OR-AE-13199/5/40/25	5908254811999	4,8	400	22	○	naturalny / natural	25
OR-AE-13199/5/40/100	5908254808623	4,8	400	22	○	naturalny / natural	100
OR-AE-13199/8/30/25	5908254812002	7,5	300	55	○	naturalny / natural	25
OR-AE-13199/8/30/100	5908254808630	7,5	300	55	○	naturalny / natural	100
OR-AE-13199/8/50/25	5908254812019	7,5	500	55	○	naturalny / natural	100
OR-AE-13199/8/50/100	5908254808647	7,5	500	55	○	naturalny / natural	100
OR-AE-13200/3/10/25	5908254812026	2,5	100	8	●	czarny / black	25
OR-AE-13200/3/10/100	5908254808678	2,5	100	8	●	czarny / black	100
OR-AE-13200/3/15/25	5908254812033	2,5	150	8	●	czarny / black	25
OR-AE-13200/3/15/100	5908254808692	2,5	150	8	●	czarny / black	100
OR-AE-13200/3/20/25	5908254812040	2,5	200	8	●	czarny / black	25
OR-AE-13200/3/20/100	5908254808708	2,5	200	8	●	czarny / black	100
OR-AE-13200/4/15/25	5908254812057	3,6	150	18	●	czarny / black	25
OR-AE-13200/4/15/100	5908254808715	3,6	150	18	●	czarny / black	100
OR-AE-13200/4/20/25	5908254812064	3,6	200	18	●	czarny / black	25
OR-AE-13200/4/20/100	5908254808739	3,6	200	18	●	czarny / black	100
OR-AE-13200/4/30/25	5908254812071	3,6	300	18	●	czarny / black	25
OR-AE-13200/4/30/100	5908254808753	3,6	300	18	●	czarny / black	100

Symbol Product no.	EAN	Szerokość [mm] Width [mm]	Długość [mm] Length [mm]	Min. wytrzymałość na zerwanie [kg] Breaking strength	Odporność na promieniowanie UV UV proof	Kolor Color	Ilość sztuk Quantity
OR-AE-13200/5/20/25	5908254812088	4,8	200	22	●	czarny / black	25
OR-AE-13200/5/20/100	5908254808784	4,8	200	22	●	czarny / black	100
OR-AE-13200/5/25/25	5908254812095	4,8	250	22	●	czarny / black	25
OR-AE-13200/5/25/100	5908254808791	4,8	250	22	●	czarny / black	100
OR-AE-13200/5/30/25	5908254812101	4,8	300	22	●	czarny / black	25
OR-AE-13200/5/30/100	5908254808807	4,8	300	22	●	czarny / black	100
OR-AE-13200/5/40/25	5908254812118	4,8	400	22	●	czarny / black	25
OR-AE-13200/5/40/100	5908254808821	4,8	400	22	●	czarny / black	100
OR-AE-13200/8/30/25	5908254812125	7,5	300	55	●	czarny / black	25
OR-AE-13200/8/30/100	5908254808838	7,5	300	55	●	czarny / black	100
OR-AE-13200/8/50/25	5908254812132	7,5	500	55	●	czarny / black	25
OR-AE-13200/8/50/100	5908254808845	7,5	500	55	●	czarny / black	100

Zestawy opasek kablowych / Sets of cable ties

Symbol Product no.	EAN	Ilość Quantity	Odporność na promieniowanie UV UV proof	Zawartość zestawu Elements of the set	Kolor Color
OR-AE-13207	5908254809026	100 szt. (pcs)	○	2,5mmx100mm x 20pcs; 2,5mmx200mm x 20pcs; 3,6mmx300mm x 20pcs; 4,8mmx300mm x 20pcs; 7,5mmx300mm x 20pcs	naturalny / natural
OR-AE-13208	5908254809033	100 szt. (pcs)	●	2,5mmx100mm x 20pcs; 2,5mmx200mm x 20pcs; 3,6mmx300mm x 20pcs; 4,8mmx300mm x 20pcs; 7,5mmx300mm x 20pcs	czarny / black



Uchwyty samoprzylepne / Self-adhesive cable tie holder

Symbol Product no.	EAN	Maks. szerokość opaski [mm] Max. cable tie width	Odporność na promieniowanie UV UV proof	Kolor Color	Montaż Installation	Otwór na śrubę [mm] Mounting hole [mm]	Wymiary (szer./wys./gf. [mm]) Dimensions (W/H/D [mm])	Ilość sztuk Quantity
OR-AE-13201/10	5908254812149	3,6	○	biały white	samoprzylepne/przykręcane self-adhesive/screwed	2,9	20 / 20 / 6,1	10
OR-AE-13201/50	5908254808852	3,6	○	biały white	samoprzylepne/przykręcane self-adhesive/screwed	2,9	20 / 20 / 6,1	50
OR-AE-13202/10	5908254812156	7,6	○	biały white	samoprzylepne/przykręcane self-adhesive/screwed	4,5	30 / 30 / 8,7	10
OR-AE-13202/50	5908254808869	7,6	○	biały white	samoprzylepne/przykręcane self-adhesive/screwed	4,5	30 / 30 / 8,7	50
OR-AE-13206/10	5908254812170	3,6	●	czarny black	samoprzylepne/przykręcane self-adhesive/screwed	2,9	20 / 20 / 6,1	10
OR-AE-13206/50	5908254811005	3,6	●	czarny black	samoprzylepne/przykręcane self-adhesive/screwed	2,9	20 / 20 / 6,1	50
OR-AE-13203/10	5908254812187	7,6	●	czarny black	samoprzylepne/przykręcane self-adhesive/screwed	4,5	30 / 30 / 8,7	10
OR-AE-13203/50	5908254808876	7,6	●	czarny black	samoprzylepne/przykręcane self-adhesive/screwed	4,5	30 / 30 / 8,7	50



Uchwyty siodełkowe / Saddle mount for cable tie

OR-AE-13235/100	5908254814990	4,8	○	biały white	przykręcane screwed	3,2	11 / 16 / 7	20
OR-AE-13236/100	5908254802157	4,8	●	czarny black	przykręcane screwed	3,2	11 / 16 / 7	100
OR-AE-13204/20	5908254812163	8,8	○	biały white	przykręcane screwed	6,8	16 / 22 / 9,5	20
OR-AE-13204/100	5908254808883	8,8	○	biały white	przykręcane screwed	6,8	16 / 22 / 9,5	100
OR-AE-13205/20	5908254812194	8,8	●	czarny black	przykręcane screwed	6,8	16 / 22 / 9,5	20
OR-AE-13205/100	5908254808890	8,8	●	czarny black	przykręcane screwed	6,8	16 / 22 / 9,5	100



Koszulki termokurczliwe

Heat shrinkable tubes

Symbol Product no.	EAN	Średnica wewnętrzna [mm] Inner diameter [mm]	Grubość ścianki [mm] Inner diameter [mm]	Współczynnik kurczenia Inner diameter	Średnica przewodu [mm] Wire diameter [mm]	Materiał Material	Kolor Color	Długość [m] Length [m]
OR-KT-13216/B	5908254813115	2,5	0,25	2:1	1,35-2,3	PE	czarny / black	1
OR-KT-13217/B	5908254813122	4	0,25	2:1	2,1-3,6	PE	czarny / black	1
OR-KT-13218/B	5908254813139	6	0,35	2:1	3,1-5,4	PE	czarny / black	1
OR-KT-13219/B	5908254813146	10	0,35	2:1	5,2-9,0	PE	czarny / black	1
OR-KT-13220/B	5908254813153	13	0,35	2:1	6,7-12	PE	czarny / black	1

Zestawy rurek termokurczliwych, 100 szt.

HEAT SHRINKABLE TUBING, 100 PCS.



Symbol Product no.	EAN	Materiał Material	Kolor Color	Wymiary (szer./wys./gi. [mm]) Dimensions (W/H/D [mm])
OR-AE-13141	5900378650515	PE	wielokolorowe multicolor	203 / 107 / 30
OR-AE-13141/B	5908254813108	PE	czarny black	203 / 107 / 30

Próbnik, tester napięcia

VOLTAGE TESTER

Płaski grot 3mm
3mm flat tip



Symbol Product no.	EAN	Zakres pomiaru Range of measurement	Sygnalizacja optyczna Optical indication	Wymiary (szer./wys./gt. [mm]) Dimensions (W/H/D [mm])
OR-AE-1321	5901752485235	100-250V AC	●	Ø2 / 140

Próbnik, tester napięcia

VOLTAGE TESTER

Płaski grot 3mm
3mm flat tip



Symbol Product no.	EAN	Zakres pomiaru Range of measurement	Sygnalizacja optyczna Optical indication	Wymiary (szer./wys./gt. [mm]) Dimensions (W/H/D [mm])
OR-AE-1322	5901752485242	100-250V AC	●	Ø2 / 190

Próbnik, tester napięcia

VOLTAGE TESTER

Płaski grot 3mm
3mm flat tip



Test kontaktowy
Contact test



Test indukcyjny
Inductive test





Symbol Product no.	EAN	Zakres pomiaru Range of measurement	Sygnalizacja optyczna Optical indication	Wymiary (szer./wys./gt. [mm]) Dimensions (W/H/D [mm])
OR-AE-1320	5901752485228	12-250V AC/DC	●	2,6 / 145 / 1,8







WENTYLATORY ŁAZIENKOWE

BATHROOM FANS











				
Symbol Product no	OR-WL-3201/100/S	OR-WL-3201/100/PS	OR-WL-3201/100/TS	OR-WL-3201/100/HS
EAN	5908254816796	5908254819360	5908254817823	5908254817830
Zasilanie Power supply	230V~, 50Hz	230V~, 50Hz	230V~, 50Hz	230V~, 50Hz
Moc Rated power	8W	8W	8W	8W
Średnica Diameter	100mm	100mm	100mm	100mm
Łożysko Bearing	kulowe ball bearing	kulowe ball bearing	kulowe ball bearing	kulowe ball bearing
Rodzaj montażu Type of assembly	ścienny lub sufitowy wall or ceiling	ścienny lub sufitowy wall or ceiling	ścienny lub sufitowy wall or ceiling	ścienny lub sufitowy wall or ceiling
Głębokość montażu w kanale Type of assembly	69mm	69mm	69mm	69mm
Ciśnienie statyczne Type of assembly	30Pa	30Pa	30Pa	30Pa
Ciśnienie akustyczne Sound pressure	26dB	26dB	26dB	26dB
Prędkość obrotowa Sound pressure	2400rpm	2400rpm	2400rpm	2400rpm
Wydatek powietrza Sound pressure	93m³/h	93m³/h	93m³/h	93m³/h
Materiał Material	ABS	ABS	ABS	ABS
Wymiary (szer./wys./gl. [mm]) Dimensions (w / h / d [mm])	120 / 120 / 89	120 / 120 / 89	120 / 120 / 89	120 / 120 / 89
Sterowanie Control	-	wyłącznik sznurkowy cord switch	wyłącznik czasowy timer	czujnik wilgotności i wyłącznik czasowy humidity sensor and timer



				
Symbol Product no	OR-WL-3200/100/S	OR-WL-3200/100/PS	OR-WL-3200/100/TS	OR-WL-3200/100/HT
EAN	5908254816758	5908254816765	5908254816772	5908254816789
Zasilanie Power supply	230V~, 50Hz	230V~, 50Hz	230V~, 50Hz	230V~, 50Hz
Moc Rated power	8W	8W	8W	8W
Średnica Diameter	100mm	100mm	100mm	100mm
Łożysko Bearing	ślizgowe plain bearing	ślizgowe plain bearing	ślizgowe plain bearing	ślizgowe plain bearing
Rodzaj montażu Type of assembly	ścienny wall	ścienny wall	ścienny wall	ścienny wall
Głębokość montażu w kanale Type of assembly	67mm	67mm	67mm	67mm
Ciśnienie statyczne Type of assembly	30Pa	30Pa	30Pa	30Pa
Ciśnienie akustyczne Sound pressure	26dB	26dB	26dB	26dB
Prędkość obrotowa Sound pressure	2400rpm	2400rpm	2400rpm	2400rpm
Wydatek powietrza Sound pressure	93m³/h	93m³/h	93m³/h	93m³/h
Materiał Material	ABS	ABS	ABS	ABS
Wymiary (szer./wys./gł. [mm]) Dimensions (w / h / d [mm])	135 / 135 / 79	135 / 135 / 79	135 / 135 / 79	135 / 135 / 79
Sterowanie Control	-	przewód z wyłącznikiem cord with switch	wyłącznik czasowy timer	czujnik wilgotności i wyłącznik czasowy humidity sensor and timer

Akcesoria do wentylatorów łazienkowych

Bathroom fans accessories

	Symbol Product no	EAN	Kolor Color	Materiał Material	Rodzaj montażu Type of assembly	szer./wys./gł. [mm] width/height/depth [mm]	Typ Type
	OR-WL-3202/100	5908254816826	biały white	ABS	ścienny lub sufitowy wall or ceiling	Ø100 / 10	zawór zwrotny check valve pasuje do OR-WL-3200 i OR-WL-3201 fits OR-WL-3200 and OR-WL-3201
	OR-WL-3205	5908254816987	biały white	ABS	ścienny lub sufitowy wall or ceiling	120 / 120 / 10	kratka wentylacyjna ventilation grille
	OR-WL-3203/GW	5908254816833	biały połysk white gloss	plexi	ścienny lub sufitowy wall or ceiling	170 / 170 / 10	panel pasuje do OR-WL-3201 i OR-WL-3205 fits OR-WL-3201 and OR-WL-3205
	OR-WL-3203/MW	5908254816840	biały mat white mat	plexi	ścienny lub sufitowy wall or ceiling	170 / 170 / 10	panel pasuje do OR-WL-3201 i OR-WL-3205 fits OR-WL-3201 and OR-WL-3205
	OR-WL-3203/B	5908254816857	czarny black	plexi	ścienny lub sufitowy wall or ceiling	170 / 170 / 10	panel pasuje do OR-WL-3201 i OR-WL-3205 fits OR-WL-3201 and OR-WL-3205
	OR-WL-3203/G	5908254816871	szary grey	plexi	ścienny lub sufitowy wall or ceiling	170 / 170 / 10	panel pasuje do OR-WL-3201 i OR-WL-3205 fits OR-WL-3201 and OR-WL-3205
	OR-WL-3203/BA	5908254816918	aluminium szczotkowane brushed aluminum	metal	ścienny lub sufitowy wall or ceiling	170 / 170 / 10	panel pasuje do OR-WL-3201 i OR-WL-3205 fits OR-WL-3201 and OR-WL-3205
	OR-WL-3204/GW	5908254816932	biały połysk white gloss	szko glass	ścienny lub sufitowy wall or ceiling	170 / 170 / 10	panel pasuje do OR-WL-3201 i OR-WL-3205 fits OR-WL-3201 and OR-WL-3205
	OR-WL-3204/MW	5908254816949	biały mat white mat	szko glass	ścienny lub sufitowy wall or ceiling	170 / 170 / 10	panel pasuje do OR-WL-3201 i OR-WL-3205 fits OR-WL-3201 and OR-WL-3205
	OR-WL-3204/GB	5908254816956	czarny połysk black gloss	szko glass	ścienny lub sufitowy wall or ceiling	170 / 170 / 10	panel pasuje do OR-WL-3201 i OR-WL-3205 fits OR-WL-3201 and OR-WL-3205
	OR-WL-3204/MB	5908254816970	czarny mat black mat	szko glass	ścienny lub sufitowy wall or ceiling	170 / 170 / 10	panel pasuje do OR-WL-3201 i OR-WL-3205 fits OR-WL-3201 and OR-WL-3205

INDEKS PRODUKTÓW

PRODUCT INDEXES

AD-NL-6136BL4	146	AD-OD-6075WLX3	133	AD-OL-6102LZM4/PZ	141
AD-NL-6136BLR4	147	AD-OD-6075WLX4	133	AD-OM-6104L4	140
AD-NL-6136PZ	163	AD-OD-6141BGU10	123	AD-OM-6104L4/B	140
AD-NL-6136ST	163	AD-OD-6141WGU10	123	AD-OM-6120L4	140
AD-NL-6136ST/B	163	AD-OD-6142BGU10	123	AD-OM-6120L4/B	140
AD-NL-6137BL4	146	AD-OD-6142WGU10	123	AD-OM-6121L4	140
AD-NL-6137BL4	163	AD-OD-6143BGU10	131	AD-OM-6121L4/B	140
AD-NL-6137BLR4	147	AD-OD-6143WGU10	131	AD-OM-6122L4	140
AD-NL-6138BL4	146	AD-OD-6144BGU10	131	AD-OM-6122L4/B	140
AD-NL-6138BL4	163	AD-OD-6144WGU10	131	AD-OM-6123L4	140
AD-NL-6138BLR4	147	AD-OD-6145BGU10	130	AD-OM-6123L4/B	140
AD-NL-6148BL4	148	AD-OD-6145WGU10	130	AD-OM-6207L4	168
AD-NL-6148BLR4	149	AD-OD-6146BGU10	130	AD-OM-6207L4/W	168
AD-NL-6148WL4	148	AD-OD-6146WGU10	130	AD-OM-6208L4	140
AD-NL-6148WLR4	149	AD-OD-6161WL4	136	AD-OM-6208L4/B	140
AD-NL-6153BL4	146	AD-OD-6162WL4	136	AD-OM-6209L4	140
AD-NL-6153BLR4	147	AD-OD-6163WL4	136	AD-OM-6209L4/B	140
AD-NR-6069L6	161	AD-OD-6168/B	128	AD-OP-6065LPM4	142
AD-NR-6093L6	161	AD-OD-6168/W	128	AD-OP-6066LPM4	142
AD-NR-6151L4	160	AD-OD-6169/B	128	AD-OP-6086LZM4	142
AD-NR-6196L6	161	AD-OD-6169/W	128	AD-OP-6087LZM4	142
AD-NR-6201L6	162	AD-OD-6170/W	126	AD-OP-6088LZM4	142
AD-NR-6202L6	162	AD-OD-6171/W	126	AD-OP-6089LZM4	142
AD-OA-6197L6	169	AD-OD-6175/B	124	AD-OP-6090LZM4	142
AD-OD-6050WLX3	134	AD-OD-6175/N	124	AD-OP-6109BLPM4	150
AD-OD-6050WLX4	134	AD-OD-6175/W	124	AD-OP-6109BLPMR4	150
AD-OD-6051WLX3	134	AD-OD-6176/B	124	AD-OP-6109GLPM4	150
AD-OD-6051WLX4	134	AD-OD-6176/N	124	AD-OP-6109GLPMR4	150
AD-OD-6052WLX3	134	AD-OD-6176/W	124	AD-OP-6109WLPM4	150
AD-OD-6052WLX4	134	AD-OD-6177/B	125	AD-OP-6109WLPMR4	150
AD-OD-6053WLX3	134	AD-OD-6177/N	125	AD-OP-6110BLPM4	152
AD-OD-6053WLX4	134	AD-OD-6177/W	125	AD-OP-6110BLPMR4	152
AD-OD-6054WLX3	135	AD-OD-6178/B	125	AD-OP-6110GLPM4	152
AD-OD-6054WLX4	135	AD-OD-6178/N	125	AD-OP-6110GLPMR4	152
AD-OD-6055WLX3	135	AD-OD-6178/W	125	AD-OP-6110WLPM4	152
AD-OD-6055WLX4	135	AD-OD-6179BE27	129	AD-OP-6110WLPMR4	152
AD-OD-6056WLX3	135	AD-OD-6179WE27	129	AD-OP-6111BLPM4	153
AD-OD-6056WLX4	135	AD-OD-6180BE27	129	AD-OP-6111BLPMR4	153
AD-OD-6057WLX3	132	AD-OD-6180WE27	129	AD-OP-6111GLPM4	153
AD-OD-6057WLX4	132	AD-OD-6181BE27	129	AD-OP-6111GLPMR4	153
AD-OD-6058WLX3	132	AD-OD-6181WE27	129	AD-OP-6111WLPM4	153
AD-OD-6058WLX4	132	AD-OD-6182	127	AD-OP-6111WLPMR4	153
AD-OD-6059WLX3	132	AD-OD-6183	127	AD-OP-6112BLPM4	153
AD-OD-6059WLX4	132	AD-OL-6099CN	141	AD-OP-6112BLPMR4	153
AD-OD-6060WLX3	133	AD-OL-6099LZM4	141	AD-OP-6112GLPM4	153
AD-OD-6060WLX4	133	AD-OL-6099LZM4/PZ	141	AD-OP-6112GLPMR4	153
AD-OD-6061WLX3	133	AD-OL-6099PZ	141	AD-OP-6112WLPM4	153
AD-OD-6061WLX4	133	AD-OL-6100LZM4	141	AD-OP-6112WLPMR4	153
AD-OD-6062WLX3	133	AD-OL-6100LZM4/PZ	141	AD-OP-6116WLPMR4	155
AD-OD-6062WLX4	133	AD-OL-6101LZM4	141	AD-OP-6117LPM4	118
AD-OD-6074WLX3	132	AD-OL-6101LZM4/PZ	141	AD-OP-6119BLPMR4	158
AD-OD-6074WLX4	132	AD-OL-6102LZM4	141	AD-OP-6119GLPMR4	158

AD-OP-6119WLPMPR4	158	AD-OS-6164LR3/N	144	OR-AE-1303/G	250
AD-OP-6125LPM4	142	AD-OS-6164LR4/B	144	OR-AE-1303/G(GS)	250
AD-OP-6126LPM4	142	AD-OS-6164LR4/N	144	OR-AE-1304	250
AD-OP-6127LPM4	142	AD-OS-6164LR4/W	144	OR-AE-1304(GS)	250
AD-OP-6131L4	164	AD-OS-6164LR6/B	144	OR-AE-1310	250
AD-OP-6132L4	164	AD-OS-6164LR6/N	144	OR-AE-1310(GS)	250
AD-OP-6133L4	164	AD-OS-6164LR6/W	144	OR-AE-1311/B	193
AD-OP-6134L4	164	AD-PD-6152LZM4	121	OR-AE-1311/W	193
AD-OP-6140LPM4	122	AD-PL-303WE27SMM	119	OR-AE-1312/B	193
AD-OP-6147BLPM4	152	AD-PL-349WLPMPR4	119	OR-AE-1312/W	193
AD-OP-6147BLPMR4	152	AD-PL-391WLPMPR4	119	OR-AE-1314	198
AD-OP-6147GLPM4	152	AD-PL-6064WLPMPR4	119	OR-AE-1314(GS)	198
AD-OP-6147GLPMR4	152	AD-PL-6076WLPMPR4	119	OR-AE-1315	198
AD-OP-6147WLPMP4	152	AD-PL-6091WLPMP4	117	OR-AE-1320	273
AD-OP-6147WLPMPR4	152	AD-PL-6091WLPMM4	120	OR-AE-1321	273
AD-OP-6157WLPMP4	116	AD-PL-6113WLPMP4	117	OR-AE-1322	273
AD-OP-6158WLPMP4	116	AD-PL-6113WLPMM4	120	OR-AE-1324/B	224
AD-OP-6159WLPMP4	116	AD-PL-6118WLPMP4	117	OR-AE-1324/G	224
AD-OP-6160WLPMP4	116	AD-PL-6118WLPMM4	120	OR-AE-1326	194
AD-OP-6189BGU10	139	AD-PL-6128WLXM4	117	OR-AE-1327	247
AD-OP-6189WGU10	139	AD-PL-6128WLXMM4	120	OR-AE-1328	247
AD-OP-6190L4	154	AD-PL-6129WLXM4	117	OR-AE-1335/B	224
AD-OP-6191L4	154	AD-PL-6129WLXMM4	120	OR-AE-1335/G	224
AD-OP-6192L4	155	AD-PL-6130WLXM4	117	OR-AE-1336/B	226
AD-OP-6193BGU10	138	AD-PL-6130WLXMM4	120	OR-AE-1336/B(GS)	226
AD-OP-6193WGU10	138	AD-PL-6134WLPMP4	122	OR-AE-1336/BR	227
AD-OP-6194BGU10	138	AD-SL-6083BLR4	159	OR-AE-1336/C	226
AD-OP-6194WGU10	138	AD-SL-6083WLR4	159	OR-AE-1336/G	226
AD-OP-6195BGU10	137	AD-SL-6107WLR4	159	OR-AE-1336/G(GS)	226
AD-OP-6195WGU10	137	AD-SL-6108BLR4	145	OR-AE-1336/GR	227
AD-OP-6204BLPM4	151	AD-SW-6115L4	165	OR-AE-1336(GS)/BR	227
AD-OP-6204BLPMR4	151	AD-SW-6124L4	165	OR-AE-1336(GS)/C	226
AD-OP-6204GLPM4	151	AD-SW-6203L4	165	OR-AE-1336(GS)/GR	227
AD-OP-6204GLPMR4	151	AD-TL-6184L3	166	OR-AE-1337/B	227
AD-OP-6204WLPMP4	151	AD-TL-6184L6	166	OR-AE-1337/B/3M	227
AD-OP-6204WLPMPR4	151	AD-TL-6185L3	166	OR-AE-1337/B(GS)	227
AD-OP-6205BLPMR4	157	AD-TL-6185L6	166	OR-AE-1337/BR	227
AD-OP-6205GLPMR4	157	AD-TL-6186L3	166	OR-AE-1337/C	227
AD-OP-6205WLPMPR4	157	AD-TL-6186L6	166	OR-AE-1337/G	227
AD-OP-6206BLPMR4	156	AD-TL-6187L3	166	OR-AE-1337/G/3M	227
AD-OP-6206GLPMR4	156	AD-TL-6187L6	166	OR-AE-1337/G(GS)	227
AD-OP-6206WLPMPR4	156	AD-TL-6188/R1-2/5	167	OR-AE-1337/GR	227
AD-OS-6164L3/B	143	AD-TL-6188/W-Z/10	167	OR-AE-1337(GS)/BR	227
AD-OS-6164L3/N	143	AD-TL-6188/Z-G/10	167	OR-AE-1337(GS)/C	227
AD-OS-6164L3/W	143	AD-TL-6188/Z-P/10	167	OR-AE-1337(GS)/GR	227
AD-OS-6164L4/B	143	AD-TL-6188/Z-P-Z/10	167	OR-AE-1338/B	224
AD-OS-6164L4/N	143	AD-TL-6188/Z-Z/10	167	OR-AE-1338/G	224
AD-OS-6164L4/W	143	OR-AB-MH-3005	89	OR-AE-1339/G	212
AD-OS-6164L6/B	143	OR-AB-MH-3005CR	89	OR-AE-1339/G(GS)	212
AD-OS-6164L6/N	143	OR-AB-MH-3005PB	89	OR-AE-1339/L	212
AD-OS-6164L6/W	143	OR-AE-1302	250	OR-AE-1339/L(GS)	212
AD-OS-6164LR3/B	144	OR-AE-1303/B	250	OR-AE-1339/T	212

OR-AE-1339/T(GS)	212	OR-AE-1373(GS)	240	OR-AE-13126/B/3M	227
OR-AE-1340	248	OR-AE-1373(GS)/B	240	OR-AE-13126/BR	227
OR-AE-1340(GS)	248	OR-AE-1374	193	OR-AE-13126/C	227
OR-AE-1341	238	OR-AE-1374/B	193	OR-AE-13126/G	227
OR-AE-1341(GS)	238	OR-AE-1377	197	OR-AE-13126/G/3M	227
OR-AE-1342	238	OR-AE-1378	197	OR-AE-13126/GR	227
OR-AE-1342(GS)	238	OR-AE-1379/B	193	OR-AE-13126(GS)/B	227
OR-AE-1346	199	OR-AE-1379/W	193	OR-AE-13126(GS)/BR	227
OR-AE-1346(GS)	199	OR-AE-1380	238	OR-AE-13126(GS)/C	227
OR-AE-1347	237	OR-AE-1381	238	OR-AE-13126(GS)/G	227
OR-AE-1347/B	237	OR-AE-1381(GS)	238	OR-AE-13126(GS)/GR	227
OR-AE-1347(GS)	237	OR-AE-1384	201	OR-AE-13127(GS)/B	228
OR-AE-1347(GS)/B	237	OR-AE-1385	201	OR-AE-13132	106
OR-AE-1348	237	OR-AE-1386	201	OR-AE-13132(GS)	106
OR-AE-1348(GS)	237	OR-AE-1387	201	OR-AE-13133(GS)/B	246
OR-AE-1349	237	OR-AE-1393/B	195	OR-AE-13133(GS)/W	246
OR-AE-1349/B	237	OR-AE-1393/W	195	OR-AE-13134/G	197
OR-AE-1349(GS)	237	OR-AE-1394/B	195	OR-AE-13134/L	197
OR-AE-1349(GS)/B	237	OR-AE-1394/W	195	OR-AE-13134/P	197
OR-AE-1350	237	OR-AE-1395/W	195	OR-AE-13134/T	197
OR-AE-1351	237	OR-AE-1397	239	OR-AE-13136	265
OR-AE-1352	237	OR-AE-1397(GS)	239	OR-AE-13137	265
OR-AE-1353	237	OR-AE-1397(GS)MB	239	OR-AE-13138	213
OR-AE-1354	237	OR-AE-1397MB	239	OR-AE-13138(GS)	213
OR-AE-1355	237	OR-AE-1398	239	OR-AE-13140	202
OR-AE-1356	237	OR-AE-1398MB	239	OR-AE-13140(GS)	202
OR-AE-1357	237	OR-AE-13109/B	227	OR-AE-13141	272
OR-AE-1359	249	OR-AE-13109/BR	227	OR-AE-13141/B	272
OR-AE-1359(GS)	249	OR-AE-13109/C	227	OR-AE-13144	211
OR-AE-1360	249	OR-AE-13109/G	227	OR-AE-13144(GS)	211
OR-AE-1361	229	OR-AE-13109/GR	227	OR-AE-13144(GS)/L	211
OR-AE-1362	229	OR-AE-13109(GS)/B	227	OR-AE-13144(GS)/W	211
OR-AE-1363	230	OR-AE-13109(GS)/BR	227	OR-AE-13144/L	211
OR-AE-1364	230	OR-AE-13109(GS)/C	227	OR-AE-13144/W	211
OR-AE-1364(GS)	230	OR-AE-13109(GS)/G	227	OR-AE-13145/B/1,5M	207
OR-AE-1367/B	243	OR-AE-13109(GS)/GR	227	OR-AE-13145/B/3M	207
OR-AE-1367/W	243	OR-AE-13110	232	ORAE13145(GS)/B/1,5M	207
OR-AE-1369	198	OR-AE-13110(GS)	232	ORAE13145(GS)/B/3M	207
OR-AE-1370	198	OR-AE-13113/G	212	ORAE13145(GS)/W/1,5M	207
OR-AE-1370(GS)	198	OR-AE-13113(GS)/G	212	ORAE13145(GS)/W/3M	207
OR-AE-1371/B	225	OR-AE-13114	195	ORAE13145(GS)/W/5M	207
OR-AE-1371/G	225	OR-AE-13114(GS)	195	OR-AE-13145/W/1,5M	207
OR-AE-1371(GS)/B	225	OR-AE-13115	195	OR-AE-13145/W/3M	207
OR-AE-1371(GS)/G	225	OR-AE-13117	199	OR-AE-13145/W/5M	207
OR-AE-1372/B	225	OR-AE-13117(GS)	199	OR-AE-13146/B/1,5M	207
OR-AE-1372/G	225	OR-AE-13124	240	OR-AE-13146/B/3M	207
OR-AE-1372(GS)/B	225	OR-AE-13124(GS)	240	ORAE13146(GS)/B/1,5M	207
OR-AE-1372(GS)/G	225	OR-AE-13125/B	228	ORAE13146(GS)/B/3M	207
OR-AE-1373	240	OR-AE-13125/B(GS)	228	ORAE13146(GS)/W/1,5M	207
OR-AE-1373/B	240	OR-AE-13126/B	227	ORAE13146(GS)/W/3M	207

ORAE13146(GS)/W/5M	207	OR-AE-13162/1,5M	209	OR-AE-13191(GS)	197
OR-AE-13146/W/1,5M	207	OR-AE-13162/B/1,5M	209	OR-AE-13192/3M	219
OR-AE-13146/W/3M	207	ORAE13162(GS)/1,5M	209	OR-AE-13192/5M	219
OR-AE-13146/W/5M	207	ORAE13162(GS)/B/1,5M	209	OR-AE-13192(GS)/3M	219
OR-AE-13149/B/3M	207	OR-AE-13163/3M	210	OR-AE-13192(GS)/5M	219
ORAE13149(GS)/B/3M	207	OR-AE-13163/B/3M	210	OR-AE-13193/3M	219
ORAE13149(GS)/W/1,5M	207	ORAE13163(GS)/3M	210	OR-AE-13193/5M	219
ORAE13149(GS)/W/3M	207	ORAE13163(GS)/B/3M	210	OR-AE-13193(GS)/3M	219
ORAE13149(GS)/W/5M	207	OR-AE-13164	200	OR-AE-13193(GS)/5M	219
OR-AE-13149/W/1,5M	207	OR-AE-13164(GS)	200	OR-AE-13194/1,5M	206
OR-AE-13149/W/3M	207	OR-AE-13165	200	OR-AE-13194/3M	206
OR-AE-13149/W/5M	207	OR-AE-13165(GS)	200	OR-AE-13194/5M	206
OR-AE-13150/B/3M	207	OR-AE-13166	200	OR-AE-13194(GS)/1,5M	207
ORAE13150(GS)/W/1,5M	207	OR-AE-13166(GS)	200	OR-AE-13194(GS)/3M	207
ORAE13150(GS)/W/3M	207	OR-AE-13167	200	OR-AE-13194(GS)/5M	207
ORAE13150(GS)/W/5M	207	OR-AE-13167(GS)	200	OR-AE-13195/1,5M	206
OR-AE-13150/W/1,5M	207	OR-AE-13169/10m	219	OR-AE-13195/3M	206
OR-AE-13150/W/3M	207	OR-AE-13169/20m	219	OR-AE-13195/5M	206
OR-AE-13150/W/5M	207	OR-AE-13169/30m	219	OR-AE-13196/B/20M	269
OR-AE-13151/BG	202	OR-AE-13169(GS)/10M	219	OR-AE-13196/B/20M/S	269
OR-AE-13151/P	202	OR-AE-13169(GS)/20M	219	OR-AE-13196/BL/20M	269
OR-AE-13151/W	202	OR-AE-13169(GS)/30M	219	OR-AE-13196/BL/20M/S	269
OR-AE-13152/30M	220	OR-AE-13170(GS)/15M	220	OR-AE-13196/BR/20M	269
OR-AE-13152(GS)/30M	220	OR-AE-13171(GS)/15M	220	OR-AE-13196/BR/20M/S	269
OR-AE-13153/30M	220	OR-AE-13178	197	OR-AE-13196/YG/20M	269
OR-AE-13153/50M	220	OR-AE-13178(GS)	197	OR-AE-13196/YG/20M/S	269
OR-AE-13153(GS)/30M	220	OR-AE-13179/B	194	OR-AE-13197/B	246
OR-AE-13153(GS)/50M	220	OR-AE-13179/W	194	OR-AE-13197/W	246
OR-AE-13154/25M	220	OR-AE-13180/B	194	OR-AE-13198	269
OR-AE-13154(GS)/25M	220	OR-AE-13180/G	194	OR-AE-13199/3/10/25	270
OR-AE-13155/50M	220	OR-AE-13180/W	194	OR-AE-13199/3/10/100	270
OR-AE-13155(GS)/50M	220	OR-AE-13182	193	OR-AE-13199/3/15/25	270
OR-AE-13156/20M	221	OR-AE-13182/B	193	OR-AE-13199/3/15/100	270
OR-AE-13156(GS)/20M	221	OR-AE-13183	193	OR-AE-13199/3/20/25	270
OR-AE-13157/30M	221	OR-AE-13183/B	193	OR-AE-13199/3/20/100	270
OR-AE-13157/40M	221	OR-AE-13184	197	OR-AE-13199/4/15/25	270
OR-AE-13157(GS)/30M	221	OR-AE-13184/B	197	OR-AE-13199/4/15/100	270
OR-AE-13157(GS)/40M	221	OR-AE-13184(GS)	197	OR-AE-13199/4/20/25	270
OR-AE-13158/3M	219	OR-AE-13184(GS)/B	197	OR-AE-13199/4/20/100	270
OR-AE-13158/5M	219	OR-AE-13185	214	OR-AE-13199/4/30/25	270
OR-AE-13158(GS)/3M	219	OR-AE-13185(GS)	214	OR-AE-13199/4/30/100	270
OR-AE-13158(GS)/5M	219	OR-AE-13186	215	OR-AE-13199/5/20/25	270
OR-AE-13159/3M	219	OR-AE-13186(GS)	215	OR-AE-13199/5/20/100	270
OR-AE-13159/5M	219	OR-AE-13187	197	OR-AE-13199/5/25/25	270
OR-AE-13159(GS)/3M	219	OR-AE-13187(GS)	197	OR-AE-13199/5/25/100	270
OR-AE-13159(GS)/5M	219	OR-AE-13188	197	OR-AE-13199/5/30/25	270
OR-AE-13160/5M	217	OR-AE-13188(GS)	197	OR-AE-13199/5/30/100	270
OR-AE-13160/10M	217	OR-AE-13190/B	209	OR-AE-13199/5/40/25	270
OR-AE-13160(GS)/5M	217	OR-AE-13190(GS)/B	209	OR-AE-13199/5/40/100	270
OR-AE-13160(GS)/10M	217	OR-AE-13191	197	OR-AE-13199/8/30/25	270

OR-AE-13199/8/30/100	270	OR-AE-13211(GS)/30M	216	OR-AK-1211	91
OR-AE-13199/8/50/25	270	OR-AE-13211(GS)/40M	216	OR-AK-1212	90
OR-AE-13199/8/50/100	270	OR-AE-13211(GS)/50M	216	OR-CR-201/B	98
OR-AE-13200/3/10/25	270	OR-AE-13212(GS)/15M	216	OR-CR-201/W	98
OR-AE-13200/3/10/100	270	OR-AE-13212(GS)/25M	216	OR-CR-203/B	98
OR-AE-13200/3/15/25	270	OR-AE-13212(GS)/30M	216	OR-CR-203/W	98
OR-AE-13200/3/15/100	270	OR-AE-13212(GS)/40M	216	OR-CR-204/B	98
OR-AE-13200/3/20/25	270	OR-AE-13212(GS)/50M	216	OR-CR-204/W	98
OR-AE-13200/3/20/100	270	OR-AE-13214/B/10M	269	OR-CR-205	100
OR-AE-13200/4/15/25	270	OR-AE-13214/B/10M/S	269	OR-CR-206	100
OR-AE-13200/4/15/100	270	OR-AE-13214/BL/10M	269	OR-CR-207	99
OR-AE-13200/4/20/25	270	OR-AE-13214/BL/10M/S	269	OR-CR-208	100
OR-AE-13200/4/20/100	270	OR-AE-13214/BR/10M	269	OR-CR-209	101
OR-AE-13200/4/30/25	270	OR-AE-13214/BR/10M/S	269	OR-CR-211	102
OR-AE-13200/4/30/100	270	OR-AE-13214/YG/10M	269	OR-CR-211/12-24V	102
OR-AE-13200/5/20/25	271	OR-AE-13214/YG/10M/S	269	OR-CR-212	101
OR-AE-13200/5/20/100	271	OR-AE-13215	269	OR-CR-213	102
OR-AE-13200/5/25/25	271	OR-AE-13221	197	OR-CR-214	100
OR-AE-13200/5/25/100	271	OR-AE-13221/B	197	OR-CR-216	100
OR-AE-13200/5/30/25	271	OR-AE-13222	198	OR-CR-218	101
OR-AE-13200/5/30/100	271	OR-AE-13222/25	198	OR-CR-219	177
OR-AE-13200/5/40/25	271	OR-AE-13223(GS)	198	OR-CR-220	100
OR-AE-13200/5/40/100	271	OR-AE-13223(GS)/25	198	OR-CR-222	99
OR-AE-13200/8/30/25	271	OR-AE-13224	194	OR-CR-223	99
OR-AE-13200/8/30/100	271	OR-AE-13228	201	OR-CR-224	99
OR-AE-13200/8/50/25	271	OR-AE-13229	201	OR-CR-225	99
OR-AE-13200/8/50/100	271	OR-AE-13230	201	OR-CR-227	101
OR-AE-13201/10	271	OR-AE-13231	201	OR-CR-229	101
OR-AE-13201/50	271	OR-AE-13232	202	OR-CR-230	176
OR-AE-13202/10	271	OR-AE-13232(GS)	202	OR-CR-231	177
OR-AE-13202/50	271	OR-AE-13234/W/1,5M	208	OR-CR-232	101
OR-AE-13203/10	271	OR-AE-13235/100	271	OR-CR-233	101
OR-AE-13203/50	271	OR-AE-13236/100	271	OR-CR-235	99
OR-AE-13204/20	271	OR-AE-13237	199	OR-CR-236/B	99
OR-AE-13204/100	271	OR-AE-13237(GS)	199	OR-CR-236/W	99
OR-AE-13205/20	271	OR-AE-13600	254	OR-CR-239	101
OR-AE-13205/100	271	OR-AE-13601	254	OR-CR-240	101
OR-AE-13206/10	271	OR-AE-13602	254	OR-CR-241	99
OR-AE-13206/50	271	OR-AE-13603	255	OR-CR-242	99
OR-AE-13207	271	OR-AE-13604	255	OR-CR-243	99
OR-AE-13208	271	OR-AE-13612/10	255	OR-CR-244	102
OR-AE-13209	199	OR-AE-13612/K/10	255	OR-CR-245	103
OR-AE-13209(GS)	199	OR-AE-13613/10	255	OR-CR-246	103
OR-AE-13210/10M	216	OR-AE-13614/2	254	OR-CR-247	99
OR-AE-13210/20M	216	OR-AE-13615	254	OR-CR-249	98
OR-AE-13210/30M	216	OR-AK-1207/G	91	OR-CR-250	99
OR-AE-13210/40M	216	OR-AK-1208/B	91	OR-CR-252	99
OR-AE-13210/50M	216	OR-AK-1208/G	91	OR-CR-253	99
OR-AE-13211(GS)/10M	216	OR-AK-1209	91	OR-CR-254/B	99
OR-AE-13211(GS)/20M	216	OR-AK-1210	91	OR-CR-254/W	99

OR-CR-255	99	OR-DOM-RL-901	43	OR-DP-VD-144/W-G/8V	29
OR-CR-256	98	OR-DOM-RL-902	45	OR-DP-VD-145/W	26
OR-CR-257	99	OR-DOM-RL-903	46	OR-DP-VD-145/W/8V	26
OR-CR-258	98	OR-DOM-RL-913	43	OR-DP-VD-146/B	27
OR-CR-259/B	97	OR-DOM-SG-918	47	OR-DP-VD-146/B/8V	27
OR-CR-259/B	99	OR-DOM-SG-919	48	OR-DP-VD-146/BG	27
OR-CR-259/W	97	OR-DOM-SL-923	48	OR-DP-VD-146/BG/8V	27
OR-CR-259/W	99	OR-DOM-SL-924	49	OR-DP-VD-146/W	27
OR-CR-260	103	OR-DP-BD-157	30	OR-DP-VD-146/W/8V	27
OR-CR-260	167	OR-DP-ML-131	31	OR-DP-VD-147/W	25
OR-CR-261	100	OR-DP-MR-148/B	22	OR-DP-VD-147/W/8V	25
OR-CR-262/B	99	OR-DP-MR-148/PW	22	OR-DP-VD-162/W	26
OR-CR-262/W	99	OR-DP-MR-148/W	22	OR-DP-VD-162/W/8V	26
OR-CR-263	98	OR-DP-MR-149/B	21	OR-DP-VD-163/W-C	28
OR-CR-264	99	OR-DP-MR-149/PW	21	OR-DP-VD-163/W-C/8V	28
OR-CR-265	99	OR-DP-MR-149/W	21	OR-DP-VD-163/W-G	28
OR-CR-267	99	OR-DP-MR-150/PW	20	OR-DP-VD-163/W-G/8V	28
OR-DB-AX-151	35	OR-DP-MR-150/W	20	OR-DP-VD-164/B	29
OR-DB-FX-152	37	OR-DP-MR-160/PW	22	OR-DP-VD-164/B/8V	29
OR-DB-FX-153	38	OR-DP-MR-160/W	22	OR-DP-VD-164/W	29
OR-DB-KF-134	34	OR-DP-MR-161/B	23	OR-DP-VD-164/W/8V	29
OR-DB-KF-135	34	OR-DP-MR-161/PW	23	OR-EZ-01	85
OR-DB-KH-122	33	OR-DP-MR-161/W	23	OR-EZ-02	85
OR-DB-KH-123	33	OR-DP-SB-133	31	OR-EZ-03	85
OR-DB-MT-156	38	OR-DP-VD-138PD1	31	OR-EZ-4001SD1	85
OR-DB-MT-165	39	OR-DP-VD-138/W	28	OR-EZ-4001SDL2	85
OR-DB-QS-158	36	OR-DP-VD-138/W/8V	28	OR-EZ-4001SDP1	85
OR-DB-QS-159	37	OR-DP-VD-139/BG	23	OR-EZ-4001SK1	85
OR-DB-QX-155	32	OR-DP-VD-139/BG/8V	23	OR-EZ-4001SRL2	85
OR-DB-YK-117	36	OR-DP-VD-139/W	23	OR-EZ-4001SRP1	85
OR-DB-YK-118	35	OR-DP-VD-139/W/8V	23	OR-EZ-4007	85
OR-DC-609	93	OR-DP-VD-140/W	24	OR-EZ-4008	85
OR-DC-614	95	OR-DP-VD-140/W/8V	24	OR-EZ-4009	85
OR-DC-619-TEST	92	OR-DP-VD-141/B	27	OR-EZ-4010	85
OR-DC-623	95	OR-DP-VD-141/B/8V	27	OR-EZ-4011	85
OR-DC-628	94	OR-DP-VD-141/BG	27	OR-EZ-4012	85
OR-DC-629	96	OR-DP-VD-141/BG/8V	27	OR-EZ-4013	85
OR-DC-630	93	OR-DP-VD-141/W	27	OR-EZ-4014	85
OR-DC-631	96	OR-DP-VD-141/W/8V	27	OR-EZ-4024	85
OR-DC-632	96	OR-DP-VD-142/BG	25	OR-EZ-4025	85
OR-DOM-AT-929/W	44	OR-DP-VD-142/BG/8V	25	OR-EZ-4026	85
OR-DOM-AT-930/W	46	OR-DP-VD-142/W	25	OR-EZ-4027	85
OR-DOM-JA-928/B	42	OR-DP-VD-142/W/8V	25	OR-EZ-4028	85
OR-DOM-JA-928/W	42	OR-DP-VD-143/W	24	OR-EZ-4029	85
OR-DOM-RE-914/B	44	OR-DP-VD-143/W/8V	24	OR-EZ-4030	85
OR-DOM-RE-914/G	44	OR-DP-VD-144/B-G	29	OR-EZ-4031	85
OR-DOM-RE-914/W	44	OR-DP-VD-144/B-G/8V	29	OR-EZ-4032	85
OR-DOM-RE-920/B	45	OR-DP-VD-144/W	29	OR-EZ-4033	85
OR-DOM-RE-920/G	45	OR-DP-VD-144/W/8V	29	OR-EZ-4034	85
OR-DOM-RE-920/W	45	OR-DP-VD-144/W-G	29	OR-EZ-4035	85

OR-EZ-4036	85	OR-GM-9010/B/USB	234	OR-KK-8100/1,5/8/B2	261
OR-EZ-4037	85	OR-GM-9010/B/USBQ	235	OR-KK-8100/1,5/10	261
OR-EZ-4038	85	OR-GM-9010/B/USBX2	234	OR-KK-8100/1,5/10/B2	261
OR-GB-417	104	OR-GM-9010/G	233	OR-KK-8100/1/8	261
OR-GB-417(GS)	104	OR-GM-9010/W	233	OR-KK-8100/1/8/B2	261
OR-GB-418	104	OR-GM-9010/W/EP	235	OR-KK-8100/1/10	261
OR-GB-418(GS)	104	OR-GM-9010/W/FR	234	OR-KK-8100/1/10/B2	261
OR-GB-420	104	OR-GM-9010/W/FR45	234	OR-KK-8100/2,5/8	261
OR-GB-420(GS)	104	OR-GM-9010/W/GS	234	OR-KK-8100/2,5/8/B2	261
OR-GB-429	105	OR-GM-9010/W/GS45	234	OR-KK-8100/2,5/10	261
OR-GB-429(GS)	105	OR-GM-9010/W/HDMI	235	OR-KK-8100/2,5/10/B2	261
OR-GB-438	104	OR-GM-9010/W/RJ11	235	OR-KK-8100/4/10	261
OR-GB-438(GS)	104	OR-GM-9010/W/RJ45	235	OR-KK-8100/4/10/B2	261
OR-GB-439	104	OR-GM-9010/W/RM	235	OR-KK-8100/6/10	261
OR-GB-439(GS)	104	OR-GM-9010/W/USB	234	OR-KK-8100/6/10/B2	261
OR-GB-440	104	OR-GM-9010/W/USBDAT1	235	OR-KK-8100/6/12	261
OR-GB-440(GS)	104	OR-GM-9010/W/USB	234	OR-KK-8100/6/12/B2	261
OR-GB-441	105	OR-GM-9010/W/USB	234	OR-KK-8100/6/12/B2	261
OR-GB-441(GS)	105	OR-GM-9010/W/USBQ	235	OR-KK-8100/10/12	261
OR-GB-447	106	OR-GM-9010/W/USBQ	235	OR-KK-8100/10/12/B2	261
OR-GB-448	106	OR-GM-9010/W/USBX2	235	OR-KK-8100/10/12/B2	261
OR-GB-449	106	OR-GM-9011/B/HDMI	245	OR-KK-8101/0,7/8	260
OR-GM-9001/B-G	251	OR-GM-9011/B/RJ45	245	OR-KK-8101/0,7/8/B2	260
OR-GM-9001/B-G(GS)	251	OR-GM-9011/B/USB	245	OR-KK-8101/1,5/8	260
OR-GM-9001/W-G	251	OR-GM-9011/W/HDMI	245	OR-KK-8101/1,5/8/B2	260
OR-GM-9001/W-G(GS)	251	OR-GM-9011/W/RJ45	245	OR-KK-8101/1,5/10	260
OR-GM-9002/B-G	251	OR-GM-9011/W/USB	245	OR-KK-8101/1,5/10/B2	260
OR-GM-9002/B-G(GS)	251	OR-GM-9013/B	243	OR-KK-8101/1/8	260
OR-GM-9002/W-G	251	OR-GM-9014(GS)/B-G	231	OR-KK-8101/1/8/B2	260
OR-GM-9002/W-G(GS)	251	OR-GM-9015/B	245	OR-KK-8101/1/10	260
OR-GM-9003/W-G	251	OR-GM-9015(GS)/B	245	OR-KK-8101/1/10/B2	260
OR-GM-9003/W-G(GS)	251	OR-GM-9015(GS)/W	245	OR-KK-8101/2,5/10	260
OR-GM-9005/W-G	251	OR-GM-9015/W	245	OR-KK-8101/2,5/10/B2	260
OR-GM-9005/W-G(GS)	251	OR-GM-9016/B-G	231	OR-KK-8101/4/12	260
OR-GM-9007/B-G	231	OR-GM-9016(GS)/B-G	231	OR-KK-8101/4/12/B2	260
OR-GM-9008/B-G	231	OR-GM-9017	238	OR-KK-8101/6/14	260
OR-GM-9009/B-G	231	OR-GM-9017(GS)	238	OR-KK-8101/6/14/B2	260
OR-GM-9010/B	233	OR-GM-9018	241	OR-KK-8102/1/4	262
OR-GM-9010/B/EP	235	OR-GM-9019/B	243	OR-KK-8102/1/4/B1	262
OR-GM-9010/B/FR	234	OR-GM-9019/G	243	OR-KK-8102/1/4/B2	262
OR-GM-9010/B/FR45	234	OR-GM-9020	242	OR-KK-8102/1/6	262
OR-GM-9010/B/GS	234	OR-GM-9021	242	OR-KK-8102/1/6/B1	262
OR-GM-9010/B/GS45	234	OR- IK-LY-931	71	OR-KK-8102/1/6/B2	262
OR-GM-9010/B/HDMI	235	OR- JB-13800	268	OR-KK-8102/2,5/4	262
OR-GM-9010/B/RJ11	235	OR- JB-13801	268	OR-KK-8102/2,5/4/B1	262
OR-GM-9010/B/RJ45	235	OR-KK-8100/0,5/8	261	OR-KK-8102/2,5/4/B2	262
OR-GM-9010/B/RM	235	OR-KK-8100/0,5/8/B2	261	OR-KK-8102/2,5/5	262
OR-GM-9010/B/UK	234	OR-KK-8100/0,7/8	261	OR-KK-8102/2,5/5/B1	262
OR-GM-9010/B/USB	234	OR-KK-8100/0,7/8/B2	261	OR-KK-8102/2,5/5/B2	262
OR-GM-9010/B/USBDAT1	235	OR-KK-8100/0,7/10	261	OR-KK-8102/2,5/6	262
		OR-KK-8100/0,7/10/B2	261	OR-KK-8102/2,5/6/B1	262
		OR-KK-8100/1,5/8	261	OR-KK-8102/2,5/6/B2	262

OR-KK-8102/2,5/8	262	OR-LZ-8200/250	181	OR-PSU-1653	184
OR-KK-8102/2,5/8/B1	262	OR-LZ-8200/400	181	OR-PSU-1654	184
OR-KK-8102/2,5/8/B2	262	OR-LZ-8200/500	181	OR-PV-13605	256
OR-KK-8102/6/4	262	OR-LZ-8201/7	180	OR-PV-13606	256
OR-KK-8102/6/4/B1	262	OR-LZ-8201/11	180	OR-PV-13607	256
OR-KK-8102/6/4/B2	262	OR-LZ-8201/15	180	OR-PV-13608	256
OR-KK-8102/6/6	262	OR-LZ-8202/7	180	OR-PV-13609	256
OR-KK-8102/6/6/B1	262	OR-LZ-8202/11	180	OR-PV-13610	256
OR-KK-8102/6/6/B2	262	OR-LZ-8202/15	180	OR-PV-13611	256
OR-KK-8102/6/8	262	OR-LZ-8203/8/BL	179	OR-SH-1731	109
OR-KK-8102/6/8/B1	262	OR-LZ-8203/8/GN	179	OR-SH-1731	110
OR-KK-8102/6/8/B2	262	OR-LZ-8203/12/BL	179	OR-SH-1732	110
OR-KK-8103/6/6/B1	262	OR-LZ-8203/12/GN	179	OR-SH-1733	110
OR-KK-8103/10/8/B1	262	OR-LZ-8204/8/BL	179	OR-SH-1734	111
OR-KK-8103/16/8/B1	262	OR-LZ-8204/8/Y	178	OR-SH-1735	111
OR-KK-8104/2,5/4/B1	263	OR-LZ-8204/12/BL	179	OR-SH-1736	111
OR-KK-8104/2,5/4/B2	263	OR-LZ-8204/12/Y	178	OR-SH-1750	111
OR-KK-8104/2,5/6/B1	263	OR-LZ-8204/18/BL	179	OR-SH-1751	111
OR-KK-8104/2,5/6/B2	263	OR-LZ-8204/18/Y	179	OR-SH-1752	110
OR-KK-8104/6/4/B1	263	OR-LZ-8205/8	178	OR-SH-1753	111
OR-KK-8104/6/4/B2	263	OR-LZ-8205/16	178	OR-SZ-8004/2/10	258
OR-KK-8104/6/6/B1	263	OR-LZ-8205/24	178	OR-SZ-8004/2/100	258
OR-KK-8104/6/6/B2	263	OR-MA-701	87	OR-SZ-8004/2/B10	258
OR-KK-8105/1/6/B1	263	OR-MA-705	87	OR-SZ-8004/3/10	258
OR-KK-8105/2,5/6/B1	263	OR-MA-710	87	OR-SZ-8004/3/100	258
OR-KK-8106/1/6/B1	263	OR-MA-711	88	OR-SZ-8004/3/B10	258
OR-KK-8106/2,5/6/B1	263	OR-MA-711PB	88	OR-SZ-8004/4/10	258
OR-KK-8107/1/6/B1	264	OR-MA-715	88	OR-SZ-8004/4/100	258
OR-KK-8107/2,5/6/B1	264	OR-MA-716	86	OR-SZ-8004/4/B10	258
OR-KK-8108/1/6/B1	264	OR-MA-716CR	86	OR-SZ-8004/5/10	258
OR-KK-8108/2,5/6/B1	264	OR-PRE-409	192	OR-SZ-8004/5/50	258
OR-KK-8109/1/B1	264	OR-PRE-409(GS)	192	OR-SZ-8004/5/B10	258
OR-KK-8109/2,5/B1	264	OR-PRE-414	176	OR-SZ-8004/6/10	258
OR-KK-8109/6/B1	264	OR-PRE-427	192	OR-SZ-8004/6/50	258
OR-KK-8110/1,5/B1	264	OR-PRE-427(GS)	192	OR-SZ-8004/6/B10	258
OR-KK-8110/2,5/B1	264	OR-PRE-432	192	OR-SZ-8004/8/10	258
OR-KK-8110/6/B1	264	OR-PRE-433	176	OR-SZ-8004/8/50	258
OR-KK-8111	265	OR-PRE-443	192	OR-SZ-8004/8/B8	258
OR-KK-8112	265	OR-PRE-443(GS)	192	OR-SZ-8005/2/10	258
OR-KK-8113	265	OR-PRE-445(GS)	192	OR-SZ-8005/2/100	258
OR-KK-8114	265	OR-PRE-446(GS)	192	OR-SZ-8005/2/B10	258
OR-KK-8115	265	OR-PSU-1641	184	OR-SZ-8005/3/10	258
OR-KT-13216/B	272	OR-PSU-1642	174	OR-SZ-8005/3/100	258
OR-KT-13217/B	272	OR-PSU-1643	174	OR-SZ-8005/3/B6	258
OR-KT-13218/B	272	OR-PSU-1644	174	OR-SZ-8005/5/10	258
OR-KT-13219/B	272	OR-PSU-1645	175	OR-SZ-8005/5/50	258
OR-KT-13220/B	272	OR-PSU-1646	175	OR-SZ-8005/5/B4	258
OR-LZ-8200/80	181	OR-PSU-1647	175	OR-SZ-8006	257
OR-LZ-8200/125	181	OR-PSU-1648	175	OR-SZ-8007	257
OR-LZ-8200/160	181	OR-PSU-1649	175	OR-SZ-8008	257

OR-SZ-8009	257	OR-WE-503	172	OR-ZL-1631	184
OR-SZ-8010/2/10	258	OR-WE-504	172	OR-ZL-1632	184
OR-SZ-8010/2/100	258	OR-WE-507	172	OR-ZL-1633	184
OR-SZ-8010/3/10	258	OR-WE-512	173	OR-ZL-1634	184
OR-SZ-8010/3/100	258	OR-WE-513	173	OR-ZL-1635	184
OR-SZ-8011/B2	259	OR-WE-514	173	OR-ZL-1636	184
OR-SZ-8012/B1	259	OR-WE-515	173	OR-ZL-1637	184
OR-SZ-8014/10	258	OR-WE-516	173	OR-ZL-1638	185
OR-SZ-8014/100	258	OR-WE-517	173	OR-ZL-1639	185
OR-SZ-8015/10	258	OR-WE-520	173	OR-ZL-1640	185
OR-SZ-8015/100	258	OR-WE-521	173	OR-ZL-1650	186
OR-SZ-8016/B4	259	OR-WIZ-1101	69	OR-ZL-1651	186
OR-VID-EX-1057/B	66	OR-WIZ-1106	70	OR-ZL-1652	186
OR-VID-EX-1057KV	63	OR-WIZ-1107	69	OR-ZS-802	74
OR-VID-EX-1057MV/B	65	OR-WIZ-1108	70	OR-ZS-803	74
OR-VID-EX-1057MV/W	65	OR-WIZ-1109	68	OR-ZS-804	74
OR-VID-EX-1057/W	66	OR-WL-3200/100/HT	275	OR-ZS-812	81
OR-VID-EX-1060PMV/B	64	OR-WL-3200/100/PS	275	OR-ZS-813	81
OR-VID-EX-1060PMV/W	64	OR-WL-3200/100/S	275	OR-ZS-814	81
OR-VID-EX-1061/B	66	OR-WL-3200/100/TS	275	OR-ZS-815	74
OR-VID-EX-1061KV	63	OR-WL-3201/100/HS	274	OR-ZS-816	75
OR-VID-EX-1061/W	66	OR-WL-3201/100/PS	274	OR-ZS-817	76
OR-VID-EX-1063KV	63	OR-WL-3201/100/S	274	OR-ZS-818	76
OR-VID-EX-1064/B	67	OR-WL-3201/100/TS	274	OR-ZS-819	81
OR-VID-EX-1064KV	63	OR-WL-3202/100	276	OR-ZS-820	73
OR-VID-EX-1064/W	67	OR-WL-3203/B	276	OR-ZS-821	73
OR-VID-EX-1066/B	67	OR-WL-3203/BA	276	OR-ZS-822	77
OR-VID-EX-1066/W	67	OR-WL-3203/G	276	OR-ZS-823	78
OR-VID-JS-1053/B	55	OR-WL-3203/GW	276	OR-ZS-824	76
OR-VID-JS-1053/W	55	OR-WL-3203/MW	276	OR-ZS-825	77
OR-VID-MC-1059/B	54	OR-WL-3204/GB	276	OR-ZS-826	78
OR-VID-MC-1059/W	54	OR-WL-3204/GW	276	OR-ZS-850	79
OR-VID-ME-1056/B	55	OR-WL-3204/MB	276	OR-ZS-851	80
OR-VID-ME-1056/W	55	OR-WL-3204/MW	276	OR-ZS-852	80
OR-VID-MT-1050	53	OR-WL-3205	276	OR-ZS-853/B	72
OR-VID-SH-1074	54	OR-ZL-1602	186	OR-ZS-853/N	72
OR-VID-SU-1058/W	53	OR-ZL-1603	186	OR-ZS-890	81
OR-VID-VP-1069/B	56	OR-ZL-1604	186	OR-ZS-891	81
OR-VID-VP-1070/B	56	OR-ZL-1605	186	OR-ZS-892	81
OR-VID-VP-1071/B	60	OR-ZL-1606	186	OR-ZS-893	81
OR-VID-VP-1072/B	60	OR-ZL-1607	186		
OR-VID-VP-1073/B	57	OR-ZL-1608	186		
OR-VID-VP-1073/W	57	OR-ZL-1609	185		
OR-VID-WI-1068/B	52	OR-ZL-1610	185		
OR-VID-XE-1051/W	57	OR-ZL-1611	185		
OR-WAT-419	191	OR-ZL-1612	185		
OR-WAT-419(GS)	191	OR-ZL-1613	185		
OR-WAT-435	191	OR-ZL-1614	185		
OR-WAT-435(GS)	191	OR-ZL-1615	185		
OR-WE-502	172	OR-ZL-1616	185		

A series of horizontal lines spanning the width of the page, intended for writing or drawing. The lines are evenly spaced and extend across the majority of the page's width.

Poznaj nas bliżej.
GET TO KNOW US.

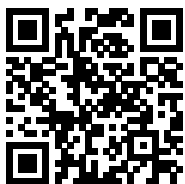

ORNO
POLSKA

ORNO-POLSKA Sp. z o.o.
ul. Rolników 437,
44-141 Gliwice,
POLAND
Phone: +48 32 43 43 110
<http://www.orno.pl>

Welcome in our world of
LIVING INNOVATIONS