



ISO 9001:2008



catalogue of products  
**03\_2019**



The company OSPEL SA is a Polish company, whose long-term experience in the production of wiring accessories reaches half of the twentieth century. Using tradition as the foundation for modern company, made a number of investments in machinery, people and technology. This allows us to attain the expected by the market requirements and expectations. With our knowledge, hard work and the honest approach, we are a reliable partner in business. Therefore OSPEL brand has become synonymous with professionalism. Our products include recognition on the European markets.



*Our mission is to provide high-quality equipment, which ensure the application of modern solutions wiring in the house.*

In the search for new design solutions, using modern technology to create high-tech, innovative products is involved a young, ambitious and creative team of engineers. To design our products we use global solutions in the field of design.

All stages of production are carried out in Poland, in sections our company, allowing us to permanently control the quality of the idea product, to deliver it to the customer. This is possible thanks to the huge investment tools that we devote to the development of design offices, software, hardware computer and modern machinery.



These investments will allow us to:

*to provide the highest quality of product, repeatability, short time-to, which is a response to the expectations of the customer.*

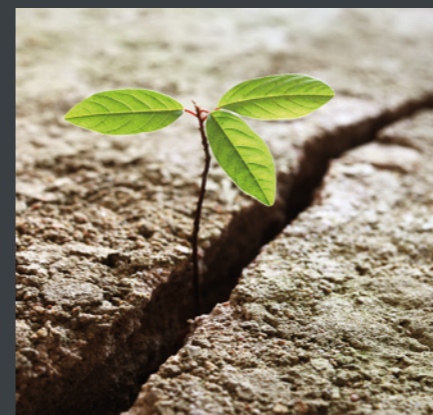

# Our Mission

Already since 2000 we have been certified Quality Management System ISO 9001: designing, manufacturing, distributing products and services, plastics processing and metalworking.

*In addition to Polish, our products are available in countries such as Germany, Sweden, Finland, Norway, Denmark, Belgium, United Kingdom, Slovakia, the Czech Republic, Romania, Bulgaria, Russia, Hungary, Ukraine, Lithuania, Estonia, Latvia, Belarus.*





## List

---

Series <b>Aria</b>	<b>5</b>
Series <b>Kier</b>	<b>21</b>
Series <b>Karo</b>	<b>27</b>
Series <b>As</b>	<b>41</b>
Series <b>Sonata</b>	<b>55</b>
Series <b>Sonata Steel Inox</b>	<b>72</b>
Series <b>Sonata New Silver</b>	<b>76</b>
Series <b>Impresja</b>	<b>81</b>
Modules <b>Keystone</b>	<b>95</b>
Series <b>Gazela</b>	<b>99</b>
Series <b>Ton</b>	<b>109</b>
Series <b>Akcent</b>	<b>119</b>
Series <b>Ospel 45</b>	<b>125</b>
Series <b>Bis</b>	<b>129</b>
Series <b>Madera</b>	<b>133</b>
Series <b>Fala</b>	<b>137</b>
Series <b>Delfina</b>	<b>141</b>
Accessories	<b>144</b>
Diagrams of switches	<b>146</b>



# Aria

SERIES



Series Aria is a combination of modern design and ideal proportions. Originality to the products is added by decorative surrounds. Thanks to them you can introduce delicate accents of colour, personalizing the accessories according to your preferences.

*Backlight switches in the Aria series are not only practical, but also interesting stylistically. Surrounding frame gives a visually attractive effect, and we have 7 colors of illumination to choose. Thanks to this we can introduce an accent color consistent with the interior design.*

# SERIES Aria

flush-mounted series



www.ospel.com.pl

## Flush mounting switches

Screwless terminals  
Rated voltage: 250V  
Rated current: 10AX  
Protection rating: IP-20



ŁP-1U/m/00  
Single pole switch 2100

ŁP-21U/m/00  
Short-circuiting switch 2104



ŁP-3U/m/00  
Two-way switch 2102



ŁP-6U/m/00  
Short-circuiting switch „bell” 2104



ŁP-11U/m/00  
Double pole switch 2107



ŁP-12US/m/00  
Control switch 2108

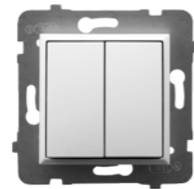

ŁP-2U/m/00  
All-or-part switch, chandelier 2101

ŁP-17U/m/00  
Double short-circuiting switch 2111



ŁP-4U/m/00  
Intermediate switch 2103



ŁP-7U/m/00  
Venetian blind switch 2105

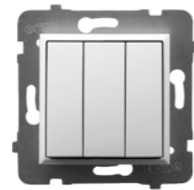

ŁP-13U/m/00  
Triple switch 2112



ŁP-9U/m/00  
Two-way + single pole switch 2109

ŁP-10U/m/00  
Double two-way switch 2110



ŁP-5U/m/00  
Short-circuiting switch „light” 2104



ŁP-7UB/m/00  
Venetian blind switch with mechanical lock 2106

## Accessories for switches IP-44

There is a possibility to mount switches with protection rating IP-20 as switches with IP-44, to do that, must be bought sealing set presented below.



ZU-1R  
Sealing set for switches IP-44 1118

Available colours



## Lighting set for switches



ZP-1UP  
Lighting set LTS orange 2100



ZP-2UG  
Lighting set LED gold 2100



ZP-2UC  
Lighting set LED red 2100



ZP-1UN  
Lighting set LTS blue 2100



ZP-2UZ  
Lighting set LED green 2100

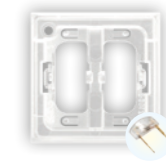

ZP-2UB  
Lighting set LED white 2100



ZP-2UN  
Lighting set LED blue 2100

## Lighting set for triple switches



ZP-3UP  
Lighting set LTS orange 2112



ZP-4UG  
Lighting set LED gold 2112



ZP-4UC  
Lighting set LED red 2112



ZP-3UN  
Lighting set LTS blue 2112



ZP-4UZ  
Lighting set LED green 2112

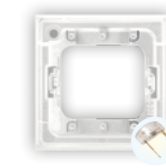

ZP-4UB  
Lighting set LED white 2112

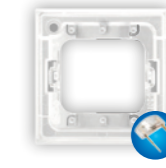

ZP-4UN  
Lighting set LED blue 2112

To order switches with built-in light look on page 17.

# SERIES Aria

flush-mounted series



www.ospel.com.pl

Available colours



## Dimmers

Screw terminals  
Current supply: 230V-50Hz  
Protection rating: IP-20



ŁP-8U/m/00 2113  
Push-turn dimmer adapted to incandescent and halogen loading, load 40-400W



ŁP-8UL2/m/00 2114  
Universal dimmer load: GLS - 10-250W, CFL - 5-75W, LED - 0-100W functions: electronic switch, "time to bed"

## Temperature regulators

Screw terminals  
Rated voltage: 230V  
Rated current:  
- incandescent 3200W  
- inductive 750W  
Protection rating: IP-20



RTP-1UN/m/00 2155  
Temperature regulator with aerial sensor



RTP-1U/m/00\* 2180  
Temperature regulator with underfloor sensor

## Electronic movement detector

Screw terminals  
Rated voltage: 230V  
Rated current:  
- incandescent 3200W,  
- fluorescent 750W  
- inductive 750W  
Protection rating: IP-20  
Way of adjustment the time of transmitter's switching on: 3s. - 5min.  
Angle of movement detection's field: 136°  
Field of activity: 7m



ŁP-16U/m/00 2154  
Electronic movement detector

## Single socket with ground with USB charger

Screwless terminals  
Rated voltage:  
- input: 230V-50Hz  
- output: 5VDC  
Rated current: 2,1A  
Protection rating: IP-20



GP-1UZPUSB/m/00 2186  
Single socket with ground, with shutters with USB charger

## Hotel switch

Current supply: 230V-50Hz  
Protection rating: IP-20  
Rated current: 16A  
Time of delay: 3 sec.

Switch works with a standard card with dimensions 86 x 54 x 0.8 mm



ŁP-15US/m/00 2153  
Hotel switch

## Triple socket EURO

Screw terminals  
Rated voltage: 250V  
Rated current: 2,5A  
Protection rating: IP-20

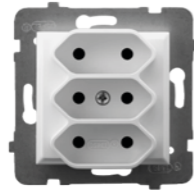

GP-3U/m/00 2127  
Triple socket EURO



GP-3UP/m/00 2127  
Triple socket EURO with shutters

## Flush mounting socket outlets

Screw terminals  
Rated voltage: 250V  
Rated current: 16A  
Protection rating: IP-20



GP-1U/m/00 2115  
Single socket



GP-1UZP/m/00 2116  
Single socket with ground, with shutters



GP-1UZD/m/00/22 2117  
Single socket with ground DATA

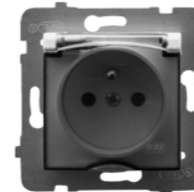

GPH-1UZ/m/00/d 2120  
Hermetic socket with ground, IP-44



GP-1UP/m/00 2115  
Single socket with shutters



GP-1US/m/00 2119  
Single socket with ground schuko



GP-1UZDP/m/00/22 2117  
Single socket with ground DATA, with shutters



GPH-1UZP/m/00/d 2120  
Hermetic socket with ground, IP-44, with shutters



GP-1UZ/m/00 2116  
Single socket with ground



GP-1USP/m/00 2119  
Single socket with ground schuko, with shutters



GP-1UZK/m/00/22 2118  
Single socket with ground DATA, with access key



GPH-1US/m/00/d 2121  
Hermetic socket with ground schuko, IP-44



GPH-1USP/m/00/d 2121  
Hermetic socket with ground schuko, IP-44, with shutters

Hermetic sockets in white and ecru colours are also offered with lid in product's colour. After right product's code write: .../00/w for products in white colour or .../27/w for products in ecru colour.

# SERIES Aria

flush-mounted series



www.ospel.com.pl

Available colours



## Flush mounting socket outlets

Screw terminals  
Rated voltage: 250V  
Rated current: 16A  
Protection rating: IP-20



GP-2UR/m/00 2124  
Twin socket



GP-2URZ/m/00 2125  
Twin socket with ground



GP-2URZP/m/00 2125  
Twin socket with ground, with shutters



GP-2U/00 2122  
Twin socket



GP-2UZP/00 2123  
Twin socket with ground, with shutters



GP-2USP/00 2126  
Twin socket with ground schuko, with shutters



GP-2UZ/00 2123  
Twin socket with ground



GP-2US/00 2126  
Twin socket with ground schuko



GP-2UC/00 2128  
Twin socket with ground, without changing phase

## Flush mounting socket outlets (sold entire)

Screw terminals  
Rated voltage: 250V  
Rated current: 16A  
Protection rating: IP-20

## Equipotential socket



GPE-1U/m/00\* 2149  
Single equipotential socket



GPE-2U/m/00\* 2150  
Twin equipotential socket



WKE\* 1571  
Plug into the equipotential socket

\* on request

## Antenna subscribers

Screw terminals



GPA-1UF/m/00 2135  
Single, terminal antenna RTV subscriber, type F



GPA-U2S/m/00 2134  
Terminal antenna RTV-SAT subscriber with two outlets SAT



GPA-2UF/m/00 2136  
Twin terminal antenna RTV subscriber, type F



GPA-UD/m/00\* 2133  
Terminal antenna RTV-DATA subscriber



GPA-US/m/00 2131  
Terminal antenna RTV-SAT subscriber, attenuation coefficient 1,5-2 dB

GPA-USP/m/00\* 2132  
Through antenna RTV-SAT subscriber, attenuation coefficient 1,2 dB



GPA-UK/m/00 2130  
Terminal antenna RTV subscriber, attenuation coefficient 2,5-3 dB

GPA-10UP/m/00\* 2129  
Through antenna RTV subscriber, attenuation coefficient 10 dB

GPA-14UP/m/00\* 2129  
Through antenna RTV subscriber, attenuation coefficient 14 dB

GPA-16UP/m/00\* 2129  
Through antenna RTV subscriber, attenuation coefficient 16 dB

GPA-10UPZ/m/00\* 2129  
Through antenna RTV subscriber

## Telephone socket

Screw terminals



GPT-1U/m/00 2137  
Single telephone socket



GPT-2UN/m/00 2138  
Twin telephone socket, independent

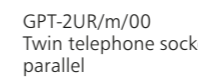

GPT-2UR/m/00 2138  
Twin telephone socket, parallel

\* on request

# SERIES Aria

flush-mounted series



www.ospel.com.pl

Available colours



## Loudspeaker sockets



GG-1U/m/00  
Single loudspeaker socket  
connection of lines ability 0,75 mm<sup>2</sup>

2146



GG-2U/m/00  
Twin loudspeaker socket  
connection of lines ability 0,75 mm<sup>2</sup>

2147



GGN-1U/m/00  
Single loudspeaker socket  
connection of lines ability 6 mm<sup>2</sup>

2148

## Computer sockets

Connection IDC



GPK-1U/K/m/00  
Single computer socket,  
5e class, MMC

2139



GPK-2U/K/m/00  
Twin computer socket,  
5e class, MMC

2142

## Sockets covers Keystone type



GPK-1U/p/00  
Single computer socket cover,  
flat

2140



GPK-1US/p/00  
Single computer socket cover,  
slant

2141



GPK-2U/p/00  
Twin computer socket cover,  
flat

2143



GPK-2US/p/00  
Twin computer socket cover,  
slant

2144



GPK-1UP/p/00  
Single computer socket cover,  
with shutter, flat

2178



GPK-2UP/p/00  
Twin computer socket cover,  
with shutter, flat

2179

Modules which can be mounted in these socket covers are on page 95.

## Cable terminal

Screw terminals, 5x4mm<sup>2</sup>  
Protection rating: IP-20  
Flush-mounted into ø60 boxes



GPPK-1U/m/00  
Cable terminal

2151

## Blank cover



Z-1U/m/00  
Blank cover

2152

## Adapter

It allows to use of OspeL 45 system products in the Aria series.



AP45-1U/m/00  
Adapter

2187

## Wall frames



PNP-1U/00  
Single wall frame

2161



PNP-2U/00  
Twin wall frame

2162



PNP-3U/00  
Threefold wall frame

2163



PNP-4U/00  
Fourfold wall frame

2164



PNP-5U/00  
Fivfold wall frame

2165







# SERIES Aria

flush-mounted series



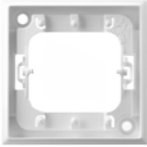

www.ospel.com.pl



## Decorative surrounds

 RO-1U/00 Decorative surround for switches 2100	 RO-13U/00 Decorative surround for triple switches 2112	 RO-2U/00 Decorative surround for single sockets outlets and dimmers 2115
 RO-3U/00 Decorative surround for twin sockets 2122	 RO-4U/00 Decorative surround for twin sockets mounted into multiple surrounds 2124	

Decorative frames in a wide range of colours are available for products from the Aria series. To order chosen surround in the place of dots must be written the number of wanted colour according to the presentation. Presented colours can differ from original.

RO-1U/...							
RO-13U/...							
RO-2U/...							
RO-3U/...	00 - white	27 - ecru	18 - silver	70 - grey matt	33 - black metallic	67 - shining silver	68 - shining gold
RO-4U/...							









Available colours

	white - 00		ecru - 27		silver - 18		grey matt - 70		black metallic - 33
---	------------	---	-----------	---	-------------	---	----------------	---	---------------------

## Surrounds Standard

white  R-1U/00 Single surround 2156 R-2U/00 Twin surround 2157 R-3U/00 Threefold surround 2158 R-4U/00 Fourfold surround 2159 R-5U/00 Fivefold surround 2160	ecru  R-1U/27 Single surround 2156 R-2U/27 Twin surround 2157 R-3U/27 Threefold surround 2158 R-4U/27 Fourfold surround 2159 R-5U/27 Fivefold surround 2160	    
---	--	---

## Surrounds Metallic

silver  R-1U/18 Single surround 2156 R-2U/18 Twin surround 2157 R-3U/18 Threefold surround 2158 R-4U/18 Fourfold surround 2159 R-5U/18 Fivefold surround 2160	grey matt  R-1U/70 Single surround 2156 R-2U/70 Twin surround 2157 R-3U/70 Threefold surround 2158 R-4U/70 Fourfold surround 2159 R-5U/70 Fivefold surround 2160	black metallic  R-1U/33 Single surround 2156 R-2U/33 Twin surround 2157 R-3U/33 Threefold surround 2158 R-4U/33 Fourfold surround 2159 R-5U/33 Fivefold surround 2160	    
--	---	--	---

Presented surrounds are universal, the products can be mounted in horizontal and vertical position.



# SERIES Aria

flush-mounted series



www.ospel.com.pl

Available colours



## Surrounds Standard for sets IP-44

white		ecru		
RH-1U/00 Single surround	2156	RH-1U/27 Single surround	2156	
RH-2U/00 Twin surround	2157	RH-2U/27 Twin surround	2157	
RH-3U/00 Threefold surround	2158	RH-3U/27 Threefold surround	2158	
RH-4U/00 Fourfold surround	2159	RH-4U/27 Fourfold surround	2159	
RH-5U/00 Fivefold surround	2160	RH-5U/27 Fivefold surround	2160	

## Surrounds Metallic for sets IP-44

silver		grey matt		black metallic		
RH-1U/18 Single surround	2156	RH-1U/70 Single surround	2156	RH-1U/33 Single surround	2156	
RH-2U/18 Twin surround	2157	RH-2U/70 Twin surround	2157	RH-2U/33 Twin surround	2157	
RH-3U/18 Threefold surround	2158	RH-3U/70 Threefold surround	2158	RH-3U/33 Threefold surround	2158	
RH-4U/18 Fourfold surround	2159	RH-4U/70 Fourfold surround	2159	RH-4U/33 Fourfold surround	2159	
RH-5U/18 Fivefold surround	2160	RH-5U/70 Fivefold surround	2160	RH-5U/33 Fivefold surround	2160	

Presented surrounds are universal, the products can be mounted in horizontal and vertical position.

## Example order

To order single pole switch in white colour with surround in black metallic colour must be ordered:

ŁP-1U/m/00  
R-1U/33



To order USB charger in white colour must be ordered:

GK-2USB/00  
AP45-1U/m/00  
R-1U/00

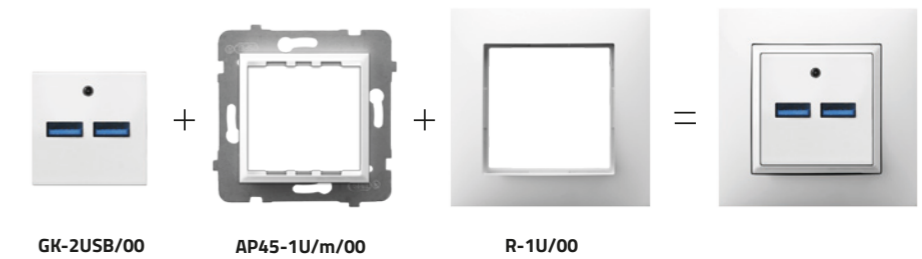

To order single pole switch in grey matt colour with lighting set LED in green colour must be ordered:

ŁP-1U/m/70  
ZP-2UZ  
R-1U/70

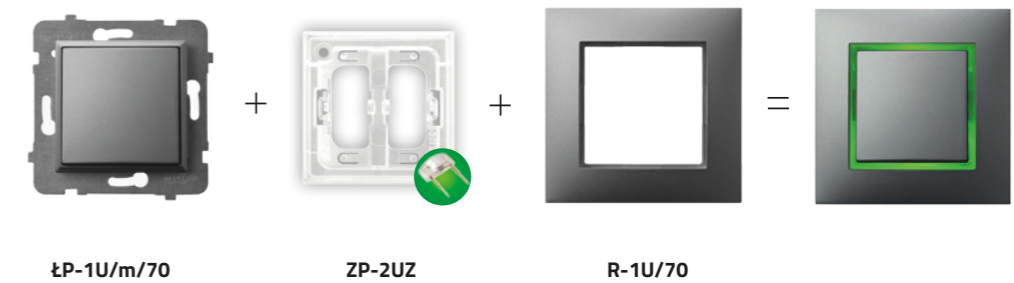

# SERIES Aria

flush-mounted series



www.ospel.com.pl

## Available colours



White – 00



Ecru – 27



Silver – 18



Grey matt – 70



Black metallic – 33

## Available lighting colours



LED gold



LED red



LTS orange

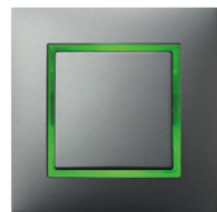

LED green

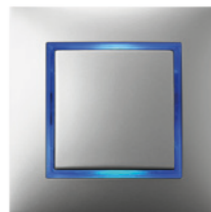

LED blue

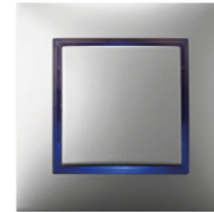

LTS blue



LED white

Available colours



white – 00



ecru – 27



silver – 18



grey matt – 70



black metallic – 33

## Examples of colour combinations



# SERIES Aria

flush-mounted series

## Designations

Products of Aria series are sold without external surround. Below are written designations which must be used to place the order. After right product's code use the right number of colour, products in colour:

White – number 00  
 Ecu – number 27  
 Silver – number 18  
 Grey matt – number 70  
 Black metallic – number 33

ŁP-.....U/m	switches - in the place marked by dots, write the right number of switch	GPT-2UN/m	twin telephone socket, independent
ŁP-8U/m	push-turn dimmer, adapted to incandescent loading and halogen loading	GPT-2UR/m	twin telephone socket, parallel
ŁP-8UL2/m	universal dimmer	GPA-1UF/m	single, terminal antenna RTV subscriber, type F
ŁP-15US/m	hotel switch	GPA-2UF/m	twin, terminal antenna RTV subscriber, type F
ŁP-16U/m	movement detector	GPA-UK/m	through antenna RTV subscriber
GP-1U/m	single socket	GPA-10UPZ/m	through antenna RTV subscriber (on request)
GP-1UP/m	single socket with shutters	GPA-10UP/m	through antenna RTV subscriber ZAP-10 (on request)
GP-1UZ/m	single socket with ground	GPA-14UP/m	through antenna RTV subscriber ZAP-14 (on request)
GP-1UZP/m	single socket with ground, with shutters	GPA-16UP/m	through antenna RTV subscriber ZAP-16 (on request)
GP-1US/m	single socket with ground schuko	GPA-US/m	terminal antenna RTV-SAT subscriber
GP-1USP/m	single socket with ground schuko, with shutters	GPA-USP/m	through antenna RTV-SAT subscriber (on request)
GP-1UZD/m	single socket with ground DATA	GPA-U2S/m	terminal antenna RTV-SAT subscriber, with two outlets SAT
GP-1UZDP/m	single socket with ground DATA, with shutters	GPA-UD/m	terminal antenna RTV-DATA subscriber (on request)
GP-1UZK/m	single socket with ground DATA, with access key	GG-1U/m	single loudspeaker socket
GPH-1UZ/m	hermetic socket with ground IP-44	GG-2U/m	twin loudspeaker socket
GPH-1UZP/m	hermetic socket with ground IP-44, with shutters	GGN-1U/m	single loudspeaker socket
GPH-1US/m	hermetic socket with ground schuko, IP-44	GPK-1U/K/m	single computer socket, 5e class, MMC
GPH-1USP/m	hermetic socket with ground schuko IP-44, with shutters	GPK-2U/K/m	twin computer socket, 5e class, MMC
GP-2UR/m	twin socket	GPK-1U/p	single socket cover, flat
GP-2URZ/m	twin socket with ground	GPK-2U/p	twin socket cover, flat
GP-2URZP/m	twin socket with ground, with shutters	GPK-1UP/p	single computer socket cover with shutter, flat
GP-2U	twin socket*	GPK-2UP/p	twin computer socket cover with shutter, flat
GP-2UZ	twin socket with ground*	GPK-1US/p	single socket cover, slant
GP-2UC	twin socket with ground, without changing phase*	GPK-2US/p	twin socket cover, slant
GP-2UZP	twin socket with ground, with shutters*	GPE-1U/m	single equipotential socket (on request)
GP-2US	twin socket with ground schuko*	GPE-2U/m	twin equipotential socket (on request)
GP-2USP	twin socket with ground schuko, with shutters*	RTP-1U/m	temperature regulator with underfloor sensor (on request)
GP-3U/m	triple socket EURO	RTP-1UN/m	temperature regulator with aerial sensor
GP-3UP/m	triple socket EURO with shutters	Z-1U/m	blank cover
GP-1UZPUSB/m	single socket with ground with USB charger	GPPK-1U/m	cable terminal
GPT-1U/m	single telephone socket	AP45-1U/m	adapter

SERIES  
**Kier**



Kier series is a modern compact line of products. Composing wiring solutions so that is very simple and accessible product range will create the interior equipped with all facilities.

*Determined, innovative design combined with intriguing patterns highlights, will surely find favor with customers. Kier is the highest quality you can always be assured by selecting products of Polish manufacturer OSPEL.*

# SERIES Kier

flush-mounted series



www.ospel.com.pl

## Flush mounting switches

Screw terminals  
Rated voltage: 250V  
Rated current: 10AX  
Protection rating: IP-20



ŁP-1W/00 1700  
Single pole switch



ŁP-2W/00 1701  
All-or-part switch, chandelier  
ŁP-17W/00 1710  
Double short-circuiting switch



ŁP-9W/00 1708  
Two-way + single pole switch  
ŁP-10W/00 1709  
Double two-way switch



ŁP-3W/00 1702  
Two-way switch



ŁP-4W/00 1703  
Intermediate switch



ŁP-5W/00 1704  
Short-circuiting switch „light“



ŁP-6W/00 1704  
Short-circuiting switch „bell“



ŁP-7W/00 1705  
Venetian blind switch



ŁP-7WB/00 1750  
Venetian blind switch with mechanical lock



ŁP-11W/00 1706  
Double pole switch

## Dimmers

Screw terminals  
Current supply: 230V ~50Hz  
Protection rating: IP-20



ŁP-8W/00 1711  
Push-turn dimmer adapted to incandescent and halogen loading, load 40-400W



ŁP-8WL2/00 1749  
Universal dimmer  
load: GLS – 10-250W, CFL – 5-75W  
LED – 0-100W  
functions: electronic switch, “time to bed”

Available colours



## Flush mounting switches with built-in light

Screw terminals  
Rated voltage: 250V  
Rated current: 10AX  
Protection rating: IP-20



ŁP-1WS/00 1700  
Single pole switch



ŁP-2WS/00 1701  
All-or-part switch, chandelier



ŁP-3WS/00 1702  
Two-way switch



ŁP-4WS/00 1703  
Intermediate switch



ŁP-5WS/00 1704  
Short-circuiting switch „light“



ŁP-6WS/00 1704  
Short-circuiting switch „bell“

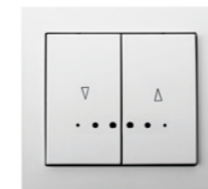

ŁP-7WS/00 1705  
Venetian blind switch

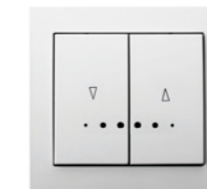

ŁP-7WS/00 1750  
Venetian blind switch with mechanical lock



ŁP-11WS/00 1706  
Double pole switch



ŁP-12WS/00 1707  
Control switch

Accessories for switches with built-in light are on page 144.

## Accessories for switches IP-44



ZU-1W 1738  
Sealing set for switches IP-44

## Wall frame



PNP-W/00 1737  
Wall frame

There is a possibility to mount switches with protection rating IP-20 as switches with IP-44, to do that must be bought accessories above.

# SERIES Kier

flush-mounted series



www.ospel.com.pl

Available colours



## Flush mounting socket outlets

Screw terminals  
Rated voltage: 250V  
Rated current: 16A  
Protection rating: IP-20



GP-1W/00  
Single socket 1712



GP-1WP/00  
Single socket with shutters 1712



GP-1WZ/00  
Single socket with ground 1713



GP-1WZP/00  
Single socket with ground, with shutters 1713



GP-1WS/00  
Single socket with ground schuko 1716



GP-1WSP/00  
Single socket with ground schuko, with shutters 1716



GP-1WZD/22\*  
Single socket with ground DATA 1714



GP-1WZDP/22\*  
Single socket with ground DATA, with shutters 1714



GP-1WZK/22\*  
Single socket with ground DATA, with access key 1715



GPH-1WZ/00/d  
Hermetic socket with ground, IP-44 1717



GPH-1WZP/00/d  
Hermetic socket with ground, IP-44, with shutters 1717



GPH-1WS/00/d  
Hermetic socket with ground schuko, IP-44 1718



GPH-1WSP/00/d  
Hermetic socket with ground schuko, IP-44, with shutters 1718

Hermetic sockets are also offered with lids in product's colour. After right product's code write: .../00/w for products in white colour or .../01/w for products in beige colour.

\* on request

## Flush mounting socket outlets

Screw terminals  
Rated voltage: 250V  
Rated current: 16A  
Protection rating: IP-20



GP-2W/00  
Twin socket 1719



GP-2WZ/00  
Twin socket with ground 1720



GP-2WZP/00  
Twin socket with ground, with shutters 1720



GP-2WS/00  
Twin socket with ground schuko 1721



GP-2WSP/00  
Twin socket with ground schuko, with shutters 1721



GP-2WC/00  
Twin socket with ground, without changing phase 1722

## Telephone socket

Screw terminals



GPT-1W/00  
Single telephone socket 1730



GPT-2WN/00  
Twin telephone socket, independent 1731



GPT-2WR/00  
Twin telephone socket, parallel 1731

## Computer sockets

Connection IDC



GPK-1W/K/00  
Single computer socket, 5e class 1732



GPK-1W/K6/00  
Single computer socket, 6 class 1734



GPK-2W/K/00  
Twin computer socket, 5e class 1733



GPK-2W/K6/00  
Twin computer socket, 6 class 1735



GPKT-W/K/00  
Conjoint computer and telephone socket 1736

# SERIES Kier

flush-mounted series

## Antenna subscribers

Screw terminals



GPA-10WP/00\* 1723  
Through antenna RTV subscriber 10 dB

GPA-14WP/00\* 1723  
Through antenna RTV subscriber 14 dB

GPA-16WP/00\* 1723  
Through antenna RTV subscriber 16 dB

GPA-10WPZ/00\* 1723  
Through antenna RTV subscriber

GPA-WK/00 1724  
Terminal antenna RTV subscriber



GPA-1WF/00 1728  
Terminal antenna RTV subscriber,  
type F, single



GPA-2WF/00 1729  
Terminal antenna RTV subscriber,  
type F, twin



GPA-WS/00 1725  
Terminal antenna RTV-SAT subscriber



GPA-WSP/00\* 1726  
Through antenna RTV-SAT subscriber



GPA-W2S/00 1727  
Terminal antenna RTV-SAT subscriber with  
two outlets SAT

\* on request

## Available colours

Products of Kier series are available in colours: 00 – White, 01 – Beige, 45 – Satin light, 52 – Brown metallic



White – nr 00



Beige – nr 01



Satin light – nr 45



Brown metallic – nr 52

# SERIES Karo



Karo is a series of products where expressive shapes of mechanisms contrast with subtle lines of frames. This is balanced option for people who want that equipment was a discreet decoration of the wall in their home.

*Following the latest colour trends, Karo products are available in two pearl colours, chocolate colour and classic white. High quality and wealthy range of products are the ideal complement to the offer.*

# SERIES Karo

flush-mounted series



www.ospel.com.pl

Available colours



## Flush mounting switches

Screw terminals  
Rated voltage: 250V  
Rated current: 10AX  
Protection rating: IP-20



ŁP-15/m/00  
Single pole switch 1500



ŁP-25/m/00  
All-or-part switch, chandelier 1501

ŁP-17S/m/00  
Double short-circuiting switch 1510



ŁP-9S/m/00  
Two-way + single pole switch 1508

ŁP-10S/m/00  
Double two-way switch 1509



ŁP-3S/m/00  
Two-way switch 1502



ŁP-4S/m/00  
Intermediate switch 1503



ŁP-5S/m/00  
Short-circuiting switch „light” 1504



ŁP-6S/m/00  
Short-circuiting switch „bell” 1504



ŁP-7S/m/00  
Venetian blind switch 1505



ŁP-7SB/m/00  
Venetian blind switch with mechanical lock 1575



ŁP-11S/m/00  
Double pole switch 1506



ŁP-13S/m/00  
Triple switch 1511

## Accessories for switches IP-44

There is a possibility to mount switches with protection rating IP-20 as switches with IP-44, to do that, must be bought sealing set presented below.



ZU-1R  
Sealing set for switches IP-44 1118

## Flush mounting switches with built-in light

Screw terminals  
Rated voltage: 250V  
Rated current: 10AX  
Protection rating: IP-20



ŁP-1SS/m/00  
Single pole switch 1500



ŁP-2SS/m/00  
All-or-part switch, chandelier 1501



ŁP-3SS/m/00  
Two-way switch 1502



ŁP-4SS/m/00  
Intermediate switch 1503



ŁP-5SS/m/00  
Short-circuiting switch „light” 1504



ŁP-6SS/m/00  
Short-circuiting switch „bell” 1504



ŁP-7SS/m/00  
Venetian blind switch 1505



ŁP-7SBS/m/00  
Venetian blind switch with mechanical lock 1575



ŁP-11SS/m/00  
Double pole switch 1506



ŁP-12SS/m/00  
Control switch 1507



ŁP-13SS/m/00  
Triple switch 1511

## Hotel switch

Screw terminals  
Current supply: 230~ 50Hz  
Protection rating: IP-20  
Rated current: 16A  
Time of delay: 3 sec.

Switch works with a standard card with dimensions 86 x 54 x 0.8 mm



ŁP-15SS/m/00  
Hotel switch 1546

Accessories for switches with built-in light are on page 144.

# SERIES Karo

flush-mounted series

## Dimmers

Screw terminals  
Current supply: 230V-50Hz  
Protection rating: IP-20



ŁP-8S/m/00 1512  
Push-turn dimmer adapted to incandescent and halogen loading, load 40-400W



ŁP-8SL2/m/00 1574  
Universal dimmer load: GLS – 10-250W, CFL – 5-75W LED – 0-100W functions: electronic switch, "time to bed"

## Temperature regulators

Screw terminals  
Rated voltage: 230V  
Rated current:  
- incandescent 3200W  
- inductive 750W  
Protection rating: IP-20



RTP-15N/m/00 1548  
Temperature regulator with aerial sensor



RTP-15/m/00\* 1548  
Temperature regulator with underfloor sensor

## Triple socket EURO

Screw terminals  
Rated voltage: 250V  
Rated current: 2,5A  
Protection rating: IP-20



GP-3S/m/00 1526  
Triple socket EURO

## Electronic movement detector

Screw terminals  
Rated voltage: 230V  
Rated current:  
- incandescent 3200W,  
- fluorescent 750W  
- inductive 750W  
Protection rating: IP-20  
Way of adjustment the time of transmitter's switching on: 3s. – 5min.  
Angle of movement detection's field: 136°  
Field of activity: 7m



ŁP-16S/m/00 1547  
Electronic movement detector

## Equipotential sockets



GPE-1S/m/00\* 1567  
Single equipotential socket



GPE-2S/m/00\* 1568  
Twin equipotential socket



WKE\* 1571  
Plug into the equipotential socket

Available colours



## Flush mounting socket outlets

Screw terminals  
Rated voltage: 250V  
Rated current: 16A  
Protection rating: IP-20



GP-1S/m/00 1514  
Single socket



GP-1SZ/m/00 1515  
Single socket with ground



GP-1SS/m/00 1518  
Single socket with ground schuko



GPH-1SZ/m/00/d 1519  
Hermetic socket with ground, IP-44



GPH-1SS/m/00/d 1520  
Hermetic socket with ground schuko, IP-44



GP-1SP/m/00 1514  
Single socket with shutters



GP-1SZP/m/00 1515  
Single socket with ground, with shutters



GP-1SSP/m/00 1518  
Single socket with ground schuko, with shutters



GPH-1SZP/m/00/d 1519  
Hermetic socket with ground, IP-44, with shutters



GPH-1SSP/m/00/d 1520  
Hermetic socket with ground schuko, IP-44, with shutters

## Single socket with ground with USB charger

Screwless terminals  
Rated voltage:  
- input: 230V-50Hz  
- output: 5VDC  
Rated current: 2,1A  
Protection rating: IP-20



GP-1SZPUSB/m/00 2068  
Single socket with ground with USB charger



GP-1SZD/m/00 1516  
Single socket with ground DATA



GP-1SZDP/m/00 1516  
Single socket with ground DATA, with shutters



GP-1SZK/m/00 1517  
Single socket with ground DATA, with access key

\* on request

Hermetic sockets in white colour are also offered with lid in white colour.  
After right product's code write: .../00/w.



# SERIES Karo

flush-mounted series

## Flush mounting socket outlets

Screw terminals  
Rated voltage: 250V  
Rated current: 16A  
Protection rating: IP-20



GP-2SR/m/00  
Twin socket 1523



GP-2SRP/m/00  
Twin socket with shutters 1523



GP-2SRZ/m/00  
Twin socket with ground 1524



GP-2SRZP/m/00  
Twin socket with ground, with shutters 1524



GP-2S/00  
Twin socket 1521



GP-2SZ/00  
Twin socket with ground 1522



GP-2SS/00  
Twin socket with ground schuko 1525



GP-2SC/00  
Twin socket with ground, without changing phase 1527



GP-2SP/00  
Twin socket with shutters 1521



GP-2SZP/00  
Twin socket with ground, with shutters 1522



GP-2SSP/00  
Twin socket with ground schuko, with shutters 1525

## Flush mounting socket outlets (sold entire)

Screw terminals  
Rated voltage: 250V  
Rated current: 16A  
Protection rating: IP-20

Available colours

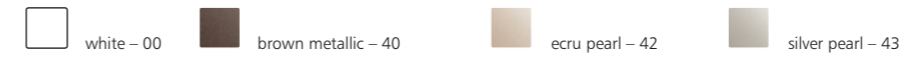

## Antenna subscribers

Screw terminals



GPA-1SF/m/00  
Single, terminal antenna RTV subscriber, type F 1533



GPA-2SF/m/00  
Twin terminal antenna RTV subscriber, type F 1534



GPA-SS/m/00  
Terminal antenna RTV-SAT subscriber, attenuation coefficient 1,5-2 dB 1530

GPA-SSP/m/00\*  
Through antenna RTV-SAT subscriber, attenuation coefficient 1,2 dB 1531



GPA-S2S/m/00  
Terminal antenna RTV-SAT subscriber with two outlets SAT 1532



GPA-SD/m/00\*  
Terminal antenna RTV-DATA subscriber 1569



GPA-SK/m/00  
Terminal antenna RTV subscriber, attenuation coefficient 2,5-3 dB 1529

GPA-10SP/m/00\*  
Through antenna RTV subscriber, attenuation coefficient 10 dB 1528

GPA-14SP/m/00\*  
Through antenna RTV subscriber, attenuation coefficient 14 dB 1528

GPA-16SP/m/00\*  
Through antenna RTV subscriber, attenuation coefficient 16 dB 1528

GPA-10SPZ/m/00\*  
Through antenna RTV subscriber 1528

## Telephone socket

Screw terminals



GPT-1S/m/00  
Single telephone socket 1535



GPT-2SN/m/00  
Twin telephone socket, independent 1536

GPT-2SR/m/00  
Twin telephone socket, parallel 1536



AP45-1S/m/00  
Adapter 1577

## Adapter

It allows to use of Ospel 45 system products in the Karo series.

\* on request



www.ospel.com.pl

# SERIES Karo

flush-mounted series



www.ospel.com.pl

## Loudspeaker sockets



GG-1S/m/00  
Single loudspeaker socket  
connection of lines ability 0,75 mm<sup>2</sup>

1544



GG-2S/m/00  
Twin loudspeaker socket  
connection of lines ability 0,75 mm<sup>2</sup>

1545



GGN-1S/m/00  
Single loudspeaker socket  
connection of lines ability 6 mm<sup>2</sup>

1573

## Computer sockets

Connection IDC



GPK-1S/K/m/00  
Single computer socket,  
5e class, MMC

1537



GPK-2S/K/m/00  
Twin computer socket,  
5e class, MMC

1538



GPKA-S/K/m/00  
Computer socket, 5e class, MMC  
+ terminal antenna RTV subscriber, type F

1570

## Sockets covers Keystone type



GPK-1S/p/00  
Single computer socket cover, flat

1537



GPK-2S/p/00  
Twin computer socket cover, flat

1538

## Cable terminal

Screw terminals, 5x4mm<sup>2</sup>  
Protection rating: IP-20  
Flush-mounted into ø60 boxes



GPPK-1S/m/00  
Cable terminal

1572

## Blank cover



Z-1S/m/00  
Blank cover

1565

Available colours



white – 00



brown metallic – 40



ecru pearl – 42



silver pearl – 43

## Surrounds Standard

white



R-1S/00 Single surround	1549	
R-2S/00 Twin surround	1550	
R-3S/00 Threefold surround	1551	
R-4S/00 Fourfold surround	1552	
R-5S/00 Fivefold surround	1553	

## Surrounds Standard for sets IP-44

white



RH-1S/00 Single surround	1549	
RH-2S/00 Twin surround	1550	
RH-3S/00 Threefold surround	1551	
RH-4S/00 Fourfold surround	1552	
RH-5S/00 Fivefold surround	1553	

## Surrounds Metallic

brown metallic



R-1S/40 Single surround	1549
R-2S/40 Twin surround	1550
R-3S/40 Threefold surround	1551
R-4S/40 Fourfold surround	1552
R-5S/40 Fivefold surround	1553

ecru pearl



R-1S/42 Single surround	1549
R-2S/42 Twin surround	1550
R-3S/42 Threefold surround	1551
R-4S/42 Fourfold surround	1552
R-5S/42 Fivefold surround	1553

silver pearl



R-1S/43 Single surround	1549	
R-2S/43 Twin surround	1550	
R-3S/43 Threefold surround	1551	
R-4S/43 Fourfold surround	1552	
R-5S/43 Fivefold surround	1553	

Presented surrounds are universal, the products can be mounted in horizontal and vertical position.

Modules which can be mounted in these socket covers are on page 95.

# SERIES Karo

flush-mounted series



www.ospel.com.pl

Available colours



white – 00



brown metallic – 40



ecru pearl – 42



silver pearl – 43

## Surrounds Metallic for sets IP-44

brown metallic		ecru pearl		silver pearl	
RH-1S/40 Single surround	1549	RH-1S/42 Single surround	1549	RH-1S/43 Single surround	1549
RH-2S/40 Twin surround	1550	RH-2S/42 Twin surround	1550	RH-2S/43 Twin surround	1550
RH-3S/40 Threefold surround	1551	RH-3S/42 Threefold surround	1551	RH-3S/43 Threefold surround	1551
RH-4S/40 Fourfold surround	1552	RH-4S/42 Fourfold surround	1552	RH-4S/43 Fourfold surround	1552
RH-5S/40 Fivefold surround	1553	RH-5S/42 Fivefold surround	1553	RH-5S/43 Fivefold surround	1553

titanium structural		wenge		burgundy	
R-1S/56 Single surround	1549	R-1S/57 Single surround	1549	R-1S/58 Single surround	1549
R-2S/56 Twin surround	1550	R-2S/57 Twin surround	1550	R-2S/58 Twin surround	1550
R-3S/56 Threefold surround	1551	R-3S/57 Threefold surround	1551	R-3S/58 Threefold surround	1551
R-4S/56 Fourfold surround	1552	R-4S/57 Fourfold surround	1552	R-4S/58 Fourfold surround	1552
R-5S/56 Fivefold surround	1553	R-5S/57 Fivefold surround	1553	R-5S/58 Fivefold surround	1553

## Color System

lime		lavender		pearl red	
R-1S/53 Single surround	1549	R-1S/54 Single surround	1549	R-1S/55 Single surround	1549
R-2S/53 Twin surround	1550	R-2S/54 Twin surround	1550	R-2S/55 Twin surround	1550
R-3S/53 Threefold surround	1551	R-3S/54 Threefold surround	1551	R-3S/55 Threefold surround	1551
R-4S/53 Fourfold surround	1552	R-4S/54 Fourfold surround	1552	R-4S/55 Fourfold surround	1552
R-5S/53 Fivefold surround	1553	R-5S/54 Fivefold surround	1553	R-5S/55 Fivefold surround	1553

satin turquoise	
R-1S/59 Single surround	1549
R-2S/59 Twin surround	1550
R-3S/59 Threefold surround	1551
R-4S/59 Fourfold surround	1552
R-5S/59 Fivefold surround	1553

Presented surrounds are universal, the products can be mounted in horizontal and vertical position.

Presented surrounds are universal, the products can be mounted in horizontal and vertical position.

# SERIES Karo

flush-mounted series



www.ospel.com.pl

## Available colours



White – 00



Brown metallic – 40



Ecru pearl – 42



Silver pearl – 43



Lime – 53



Lavender – 54



Pearl red – 55



Titanium structural – 56



Wenge – 57



Burgundy – 58



Satin turquoise – 59

Available colours



white – 00



brown metallic – 40



ecru pearl – 42



silver pearl – 43

## Example order



ŁP-1S/m/00

+



R-1S/00

=



To order single pole switch in white colour must be ordered:

ŁP-1S/m/00  
R-1S/00

To order single pole switch with built-in light in brown metallic colour must be ordered:

ŁP-1SS/m/40  
R-1S/40

To order single socket with ground in ecru pearl colour must be ordered:

GP-1SZ/m/42  
R-1S/42

To order twin socket in silver pearl colour must be ordered:

GP-2S/43

# SERIES Karo

flush-mounted series

## Designations

Products of KARO series (\*excluding a few twin sockets) in all colours are sold without external surround. Below are written designations which must be used to place the order.

After right product's code write the right number of colour  
 white – number 00  
 brown metallic – number 40  
 ecru pearl – number 42  
 silver pearl – number 43

ŁP-.....S/m	switches - in the place marked by dots, write the right number of switch	GP-3S/m	triple socket EURO
ŁP-.....SS/m	switches with built-in light - in the place marked by dots, write the right number of switch	GPT-1S/m	single telephone socket
ŁP-8S/m	push-turn dimmer adapted to incandescent and halogen loading	GPT-2SN/m	twin telephone socket, independent
ŁP-8SL2/m	universal dimmer	GPT-2SR/m	twin telephone socket, parallel
ŁP-15SS/m	hotel switch	GPA-1SF/m	single antenna RTV subscriber type F
ŁP-16S/m	electronic movement detector	GPA-2SF/m	twin, terminal antenna RTV subscriber, type F
GP-1S/m	single socket	GPA-SK/m	terminal antenna RTV subscriber ZAR-1
GP-1SP/m	single socket with shutters	GPA-10SPZ/m	through antenna RTV subscriber (on request)
GP-1SZ/m	single socket with ground	GPA-10SP/m	through antenna RTV subscriber ZAP-10 (on request)
GP-1SZP/m	single socket with ground, with shutters	GPA-14SP/m	through antenna RTV subscriber ZAP-14 (on request)
GP-1SS/m	single socket with ground schuko	GPA-16SP/m	through antenna RTV subscriber ZAP-16 (on request)
GP-1SSP/m	single socket with ground schuko, with shutters	GPA-SS/m	terminal antenna RTV-SAT subscriber
GP-1SZD/m	single socket with ground DATA	GPA-SSP/m	through antenna RTV-SAT subscriber (on request)
GP-1SZDP/m	single socket with ground DATA, with shutters	GPA-S2S/m	terminal antenna RTV-SAT subscriber with two outlets SAT
GP-1SZK/m	single socket with ground DATA, with access key	GPA-SD/m	terminal antenna RTV-DATA subscriber (on request)
GPH-1SZ/m	hermetic socket with ground IP-44	GG-1S/m	single loudspeaker socket
GPH-1SZP/m	hermetic socket with ground IP-44, with shutters	GG-2S/m	twin loudspeaker socket
GPH-1SS/m	hermetic socket with ground schuko, IP-44	GGN-1S/m	single loudspeaker socket
GPH-1SSP/m	hermetic socket with ground schuko, IP-44, with shutters	GPK-1S/K/m	single computer socket, 5e class, MMC
GP-1SZPUSB/m	single socket with ground with USB charger	GPK-2S/K/m	twin computer socket 5e class, MMC
GP-2SR/m	twin socket	GPK-1S/p	single computer socket cover, flat
GP-2SRP/m	twin socket with shutters	GPK-2S/p	twin computer socket cover, flat
GP-2SRZ/m	twin socket with ground	GPKA-S/K/m	computer socket + terminal antenna RTV subscriber, type F
GP-2SRZP/m	twin socket with ground, with shutters	GPE-1S/m	single equipotential socket (on request)
GP-2S	twin socket*	GPE-2S/m	twin equipotential socket (on request)
GP-2SP	twin socket with shutters*	RTP-1S/m	temperature regulator with underfloor sensor (on request)
GP-2SZ	twin socket with ground*	RTP-1SN/m	temperature regulator with aerial sensor
GP-2SZP	twin socket with ground, with shutters*	Z-1S/m	blank cover
GP-2SS	twin socket with ground schuko*	GPPK-1S/m	cable terminal
GP-2SSP	twin socket with ground schuko, with shutters*	AP45-1S/m	adapter

# SERIES As



Series As is a geometric form which frames are broken with gentle curves. It is a combination of dynamic design with neutral colours which can be used in any room.

*The materials of the highest quality and timeless design, helped create a product that will be the pride of your interior for many years.*

# SERIES As

flush-mounted series



www.ospel.com.pl

## Flush mounting switches

Screw terminals  
Rated voltage: 250V  
Rated current: 10AX  
Protection rating: IP-20



ŁP-1G/m/00  
Single pole switch 1300



ŁP-2G/m/00  
All-or-part switch, chandelier 1301

ŁP-17G/m/00  
Double short-circuiting switch 1363



ŁP-9G/m/00  
Two-way + single pole switch 1308

ŁP-10G/m/00  
Double two-way switch 1309



ŁP-3G/m/00  
Two-way switch 1302



ŁP-4G/m/00  
Intermediate switch 1303



ŁP-5G/m/00  
Short-circuiting switch „light” 1304



ŁP-6G/m/00  
Short-circuiting switch „bell” 1304



ŁP-7G/m/00  
Venetian blind switch 1305



ŁP-7GB/m/00  
Venetian blind switch with mechanical lock 2010



ŁP-11G/m/00  
Double pole switch 1306



ŁP-13G/m/00  
Triple switch 1310

## Accessories for switches IP-44

There is a possibility to mount switches with protection rating IP-20 as switches with IP-44, to do that, must be bought sealing set presented below.



ZU-1G  
Sealing set for switches IP-44 1352

Available colours



## Flush mounting switches with built-in light

Screw terminals  
Rated voltage: 250V  
Rated current: 10AX  
Protection rating: IP-20



ŁP-1GS/m/00  
Single pole switch 1300



ŁP-2GS/m/00  
All-or-part switch, chandelier 1301



ŁP-3GS/m/00  
Two-way switch 1302



ŁP-4GS/m/00  
Intermediate switch 1303



ŁP-5GS/m/00  
Short-circuiting switch „light” 1304



ŁP-6GS/m/00  
Short-circuiting switch „bell” 1304



ŁP-7GS/m/00  
Venetian blind switch 1305

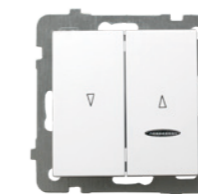

ŁP-7GBS/m/00  
Venetian blind switch with mechanical lock 2010



ŁP-11GS/m/00  
Double pole switch 1306



ŁP-12GS/m/00  
Control switch 1307



ŁP-13GS/m/00  
Triple switch 1310

## Hotel switch

Screw terminals  
Current supply: 230~ 50Hz  
Protection rating: IP-20  
Rated current: 16A  
Time of delay: 3 sec.

Switch works with a standard card with dimensions 86 x 54 x 0.8 mm



ŁP-15GS/m/00  
Hotel switch 1342

Accessories for switches with built-in light are on page 144.

# SERIES As

flush-mounted series



www.ospel.com.pl

## Dimmers

Screw terminals  
Current supply: 230V-50Hz  
Protection rating: IP-20



ŁP-8G/m/00 1311  
Push-turn dimmer adapted to incandescent and halogen loading, load 40-400W



ŁP-8GL2/m/00 2007  
Universal dimmer  
load: GLS – 10-250W, CFL – 5-75W  
LED – 0-100W  
functions: electronic switch, "time to bed"

## Temperature regulators

Screw terminals  
Rated voltage: 230V  
Rated current:  
- incandescent 3200W  
- inductive 750W  
Protection rating: IP-20



RTP-1GN/m/00 1388  
Temperature regulator with aerial sensor



RTP-1G/m/00\* 1344  
Temperature regulator with underfloor sensor

## Triple socket EURO

Screw terminals  
Rated voltage: 250V  
Rated current: 2,5A  
Protection rating: IP-20



GP-3G/m/00 1325  
Triple socket EURO

## Electronic movement detector

Screw terminals  
Rated voltage: 230V  
Rated current:  
- incandescent 3200W,  
- fluorescent 750W  
- inductive 750W  
Protection rating: IP-20  
Way of adjustment: the time of transmitter's switching on: 3s. – 5min.  
Angle of movement detection's field: 136°  
Field of activity: 7m



ŁP-16G/m/00 1343  
Electronic movement detector

## Equipotential sockets



GPE-1G/m/00\* 1382  
Single equipotential socket



GPE-2G/m/00\* 1383  
Twin equipotential socket



WKE\* 1571  
Plug into the equipotential socket

Available colours



## Flush mounting socket outlets

Screw terminals  
Rated voltage: 250V  
Rated current: 16A  
Protection rating: IP-20



GP-1G/m/00 1313  
Single socket



GP-1GZP/m/00 1314  
Single socket with ground, with shutters



GP-1GZD/m/00 1315  
Single socket with ground DATA



GP-1GZD/m/12 1315  
Single socket with ground DATA



GP-1GP/m/00 1313  
Single socket with shutters



GP-1GS/m/00 1317  
Single socket with ground schuko



GP-1GZDP/m/00 1315  
Single socket with ground DATA, with shutters



GP-1GZDP/m/12 1315  
Single socket with ground DATA, with shutters



GP-1GZ/m/00 1314  
Single socket with ground



GP-1GSP/m/00 1317  
Single socket with ground schuko, with shutters



GP-1GZK/m/00 1316  
Single socket with ground DATA, with access key



GP-1GZK/m/12 1316  
Single socket with ground DATA, with access key

\* on request

# SERIES As

flush-mounted series



www.ospel.com.pl

## Flush mounting socket outlets

Screw terminals  
Rated voltage: 250V  
Rated current: 16A  
Protection rating: IP-20



GPH-1GZ/m/00/d  
Hermetic socket  
with ground, IP-44

1318



GPH-1GZP/m/00/d  
Hermetic socket  
with ground, IP-44,  
with shutters

1318



GPH-1GS/m/00/d  
Hermetic socket  
with ground schuko, IP-44

1319



GPH-1GSP/m/00/d  
Hermetic socket with ground  
schuko, IP-44, with shutters

1319

Hermetic sockets are also offered with lid in product's colour. After right product's code write-  
.../00/w for products in white colour or .../27/w for products in ecru colour.

## Single socket with ground with USB charger

Screwless terminals  
Rated voltage:  
– input: 230V~50Hz  
– output: 5VDC  
Rated current: 2,1A  
Protection rating: IP-20



GP-1GZPUSB/m/00  
Single socket with ground  
with USB charger

2067

Available colours



white - 00



ecru - 27



silver - 18

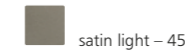

satin light - 45

## Flush mounting socket outlets

Screw terminals  
Rated voltage: 250V  
Rated current: 16A  
Protection rating: IP-20



GP-2GR/m/00  
Twin socket

1322



GP-2GRP/m/00  
Twin socket with shutters

1322



GP-2GRZ/m/00  
Twin socket with ground

1323



GP-2GRZP/m/00  
Twin socket with ground,  
with shutters

1323

## Flush mounting socket outlets (sold entire)

Screw terminals  
Rated voltage: 250V  
Rated current: 16A  
Protection rating: IP-20



GP-2G/00  
Twin socket

1320



GP-2GZ/00  
Twin socket with ground

1321



GP-2GS/00  
Twin socket with ground schuko

1324



GP-2GC/00  
Twin socket with ground,  
without changing phase

1326



GP-2GP/00  
Twin socket with shutters

1320



GP-2GZP/00  
Twin socket with ground,  
with shutters

1321



GP-2GSP/00  
Twin socket with ground  
schuko, with shutters

1324



# SERIES As

flush-mounted series



www.ospel.com.pl

## Antenna subscribers

Screw terminals



GPA-1GF/m/00 1332  
Terminal antenna RTV subscriber,  
type F, single



GPA-2GF/m/00 1375  
Terminal antenna RTV subscriber,  
type F, twin



GPA-GK/m/00 1328  
Terminal antenna RTV subscriber,  
attenuation coefficient 2,5-3 dB

GPA-10GPZ/m/00\* 1327  
Through antenna RTV subscriber,  
attenuation coefficient 10 dB



GPA-10GP/m/00\* 1327  
Through antenna RTV subscriber,  
attenuation coefficient 10 dB

GPA-14GP/m/00\* 1327  
Through antenna RTV subscriber,  
attenuation coefficient 14 dB

GPA-16GP/m/00\* 1327  
Through antenna RTV subscriber,  
attenuation coefficient 16 dB



GPA-GS/m/00 1329  
Terminal antenna RTV-SAT subscriber,  
attenuation coefficient 1,5-2 dB

GPA-GSP/m/00\* 1330  
Through antenna RTV-SAT subscriber,  
attenuation coefficient 1,2 dB



GPA-G2S/m/00 1331  
Terminal antenna RTV-SAT subscriber  
with two outlets SAT



GPA-GD/m/00\* 1384  
Terminal antenna  
RTV-DATA subscriber

## Telephone socket

Screw terminals



GPT-1G/m/00 1333  
Single telephone socket



GPT-2GN/m/00 1334  
Twin telephone socket,  
independent

GPT-2GR/m/00 1334  
Twin telephone socket,  
parallel

## Adapter

It allows to use of Ospel 45 system products  
in the As series.



AP45-1G/m/00 2058  
Adapter

Available colours



## Loudspeaker sockets

Connection of lines ability 0,75 mm<sup>2</sup>



GG-1G/m/00 1340  
Single loudspeaker socket  
connection of lines ability 0,75 mm<sup>2</sup>



GG-2G/m/00 1341  
Twin loudspeaker socket  
connection of lines ability 0,75 mm<sup>2</sup>



GGN-1G/m/00 1387  
Single loudspeaker socket  
connection of lines ability 6 mm<sup>2</sup>

## Computer sockets

Connection IDC



GPK-1G/K/m/00 1335  
Single computer socket,  
5e class, MMC



GPK-2G/K/m/00 1336  
Twin computer socket  
5e class, MMC

## Sockets covers Keystone type



GPK-1GS/p/00 1366  
Single computer socket cover, slant



GPK-2GS/p/00 1367  
Twin computer socket cover, slant



GPK-1G/p/00 1394  
Single computer socket cover, flat



GPK-2G/p/00 1395  
Twin computer socket cover, flat

Modules which can be mounted in these socket covers are on page 95.

\* on request

# SERIES As

flush-mounted series

## Blank cover



Z-1G/m/00  
Blank cover

1362

## Cable terminal

Screw terminals, 5x4mm<sup>2</sup>  
Protection rating: IP-20  
Flush-mounted into ø60 boxes



GPPK-1G/m/00  
Cable terminal

1140

## Wall frames



PNP-1G/00  
Single wall frame

1051



PNP-2G/00  
Twin wall frame

1052



PNP-3G/00  
Threefold wall frame

1053



PNP-4G/00  
Fourfold wall frame

1054



PNP-5G/00  
Fivefold wall frame

1055



Available colours



white – 00



ecru – 27



silver – 18



satin light – 45



www.ospel.com.pl

## Surrounds Standard

white



R-1G/00  
Single surround

1347

R-2G/00  
Twin surround

1348

R-3G/00  
Threefold surround

1349

R-4G/00  
Fourfold surround

1350

R-5G/00  
Fivefold surround

1351

ecru



R-1G/27  
Single surround

1347

R-2G/27  
Twin surround

1348

R-3G/27  
Threefold surround

1349

R-4G/27  
Fourfold surround

1350

R-5G/27  
Fivefold surround

1351



## Surrounds Standard for sets IP-44

white



RH-1G/00  
Single surround

1347

RH-2G/00  
Twin surround

1348

RH-3G/00  
Threefold surround

1349

RH-4G/00  
Fourfold surround

1350

RH-5G/00  
Fivefold surround

1351

ecru



RH-1G/27  
Single surround

1347

RH-2G/27  
Twin surround

1348

RH-3G/27  
Threefold surround

1349

RH-4G/27  
Fourfold surround

1350

RH-5G/27  
Fivefold surround

1351



Presented surrounds are universal, the products can be mounted in horizontal and vertical position.

# SERIES As

flush-mounted series



www.ospel.com.pl

## Surrounds Metallic

silver



R-1G/18	1347
Single surround	
R-2G/18	1348
Twin surround	
R-3G/18	1349
Threefold surround	
R-4G/18	1350
Fourfold surround	
R-5G/18	1351
Fivefold surround	

satin light



R-1G/45	1347	
Single surround		
R-2G/45	1348	
Twin surround		
R-3G/45	1349	
Threefold surround		
R-4G/45	1350	
Fourfold surround		
R-5G/45	1351	
Fivefold surround		

Available colours



## Available colours



White - nr 00



Silver - nr 18



Ecru - nr 27



Satin light - nr 45

## Surrounds Metallic for sets IP-44

silver



RH-1G/18	1347
Single surround	
RH-2G/18	1348
Twin surround	
RH-3G/18	1349
Threefold surround	
RH-4G/18	1350
Fourfold surround	
RH-5G/18	1351
Fivefold surround	

satin light



RH-1G/45	1347	
Single surround		
RH-2G/45	1348	
Twin surround		
RH-3G/45	1349	
Threefold surround		
RH-4G/45	1350	
Fourfold surround		
RH-5G/45	1351	
Fivefold surround		

## Example order



ŁP-1G/m/00

+



R-1G/00

=



To order single pole switch in white colour must be ordered:  
ŁP-1G/m/00  
R-1G/00

To order single pole switch with built-in light in ecru colour must be ordered:  
ŁP-1GS/m/27  
R-1G/27

Presented surrounds are universal, the products can be mounted in horizontal and vertical position.

# SERIES As

flush-mounted series

## Designations

Products of AS series (\*excluding a few twin sockets) in all colours are sold without external surround. Below are written designations which must be used to place the order.

After right product's code write the right number of colour:

white – number 00  
 ecru - number 27  
 satin light - number 45  
 sliver - number 18

ŁP-.....G/m	switches - in the place marked by dots, write the right number of switch	GP-3G/m	triple socket EURO
ŁP-.....GS/m	switches with built-in light - in the place marked by dots, write the right number of switch	GPT-1G/m	single telephone socket
ŁP-8G/m	push-turn dimmer adapted to incandescent and halogen loading	GPT-2GN/m	twin telephone socket, independent
ŁP-8GL2/m/	universal dimmer	GPT-2GR/m	twin telephone socket, parallel
ŁP-15GS/m	hotel switch	GPA-10GP/m	through antenna RTV subscriber ZAP-10 (on request)
ŁP-16G/m	electronic movement detector	GPA-14GP/m	through antenna RTV subscriber ZAP-14 (on request)
GP-1G/m	single socket	GPA-16GP/m	through antenna RTV subscriber ZAP-16 (on request)
GP-1GP/m	single socket with shutters	GPA-10GPZ/m	through antenna RTV subscriber (on request)
GP-1GZ/m	single socket with ground	GPA-GK/m	terminal antenna RTV subscriber ZAR-1
GP-1GZP/m	single socket with ground, with shutters	GPA-GS/m	terminal antenna RTV-SAT subscriber
GP-1GS/m	single socket with ground schuko	GPA-GSP/m	through antenna RTV-SAT subscriber (on request)
GP-1GSP/m	single socket with ground schuko, with shutters	GPA-G2S/m	terminal antenna RTV-SAT subscriber with two outlets SAT
GP-1GZD/m	single socket with ground DATA	GPA-GD/m	terminal antennaRTV-DATA subscriber (on request)
GP-1GZDP/m	single socket with ground DATA, with shutters	GPA-1GF/m	single antenna RTV subscriber type F
GP-1GZK/m	single socket with ground DATA, with access key	GPA-2GF/m	gniazdo antenowe podwójne type F
GPH-1GZ/m	hermetic socket with ground, IP-44	GG-1G/m	single loudspeaker socket
GPH-1GZP/m	hermetic socket with ground IP-44, with shutters	GG-2G/m	twin loudspeaker socket
GPH-1GS/m	hermetic socket with ground schuko, IP-44	GGN-1G/m/	single loudspeaker socket
GPH-1GSP/m	hermetic socket with ground schuko, IP-44, with shutters	GPK-1G/K/m	single computer socket, 5e class, MMC
GP-1GZPUSB/m	single socket with ground with USB charger	GPK-2G/K/m	twin computer socket 5e class, MMC
GP-2GR/m	twin socket	GPE-1G/m	single equipotential socket (on request)
GP-2GRP/m	twin socket with shutters	GPE-2G/m	twin equipotential socket (on request)
GP-2GRZ/m	twin socket with ground	GPK-1GS/p	single computer socket cover, slant
GP-2GRZP/m	twin socket with ground, with shutters	GPK-2GS/p	twin computer socket cover, slant
GP-2G	twin socket*	GPK-1G/p	single computer socket cover, flat
GP-2GP	twin socket with shutters*	GPK-2G/p	twin computer socket cover, flat
GP-2GZ	twin socket with ground*	RTP-1G/m	temperature regulator with underfloor sensor (on request)
GP-2GZP	twin socket with ground, with shutters*	RTP-1GN/m	temperature regulator with aerial sensor
GP-2GS	twin socket with ground schuko*	Z-1G/m	blank cover
GP-2GSP	twin socket with ground schuko, with shutters*	GPPK-1G/m	cable terminal
GP-2GC	twin socket without changing phase*	AP45-1G/m	adapter



# Sonata

SERIES



Series Sonata will satisfy followers of the latest trends, captivates their shape and elegance.

*Thanks to its design, the Sonata perfectly fits to modern interiors. Simple form, elegance, high quality and functionality are the main features distinguishing this series.*

# SERIES Sonata

flush-mounted series

## Flush mounting switches

Screwless terminals  
Rated voltage: 250V  
Rated current: 16AX  
Protection rating: IP-20



ŁP-1R/m/00  
Single pole switch 1068



ŁP-3R/m/00  
Two-way switch 1070



ŁP-2R/m/00  
All-or-part switch, chandelier 1069

ŁP-9R/m/00  
Two-way switch  
+ single pole switch 1075

ŁP-10R/m/00  
Double two-way switch 1076



ŁP-4R/m/00  
Intermediate switch 1071



ŁP-11R/m/00  
Double pole switch 1074

Rated current: 10AX



ŁP-5R/m/00  
Short-circuiting switch „light” 1072



ŁP-6R/m/00  
Short-circuiting switch „bell” 1072



ŁP-7R/m/00  
Venetian blind switch 1073



ŁP-7RB/m/00  
Venetian blind switch  
with mechanical lock 2009



ŁP-13R/m/00  
Triple switch 1117



ŁP-17R/m/00  
Double short-circuiting switch 1132

## Accessories for switches IP-44

There is a possibility to mount switches with protection rating IP-20 as switches with IP-44, to do that, must be bought sealing set presented below.



ZU-1R  
Sealing set for switches IP-44 1118

Available colours

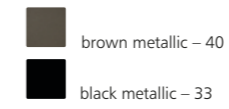
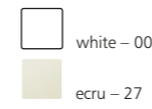

www.ospel.com.pl

## Flush mounting switches with built-in light

Screwless terminals  
Rated voltage: 250V  
Rated current: 16AX  
Protection rating: IP-20



ŁP-1RS/m/00  
Single pole switch 1068



ŁP-2RS/m/00  
All-or-part switch, chandelier 1069



ŁP-3RS/m/00  
Two-way switch 1070



ŁP-4RS/m/00  
Intermediate switch 1071



ŁP-11RS/m/00  
Double pole switch 1074



ŁP-12RS/m/00  
Control switch 1131

Rated current: 10AX



ŁP-5RS/m/00  
Short-circuiting switch „light” 1072



ŁP-6RS/m/00  
Short-circuiting switch „bell” 1072



ŁP-7RS/m/00  
Venetian blind switch 1073



ŁP-7RBS/m/00  
Venetian blind switch  
with mechanical lock 2009



ŁP-13RS/m/00  
Triple switch 1117

## Hotel switch

Screw terminals  
Current supply: 230~ 50Hz  
Protection rating: IP-20  
Rated current: 16A  
Time of delay: 3 sec.

Switch works with a standard card with dimensions 86 x 54 x 0.8 mm



ŁP-15RS/m/00  
Hotel switch 1107

Accessories for switches with built-in light are on page 144.

# SERIES Sonata

flush-mounted series

## Dimmers

Screw terminals  
Current supply: 230V ~50Hz  
Protection rating: IP-20



ŁP-8R/m/00 1077  
Push-turn dimmer adapted to incandescent and halogen loading, load 40-400W



ŁP-8RL2/m/00 2006  
Universal dimmer load: GLS – 10-250W, CFL – 5-75W LED – 0-100W functions: electronic switch, "time to bed"

## Temperature regulators

Screw terminals,  
Rated voltage: 230V  
Rated current:  
- incandescent 3200W  
- inductive 750W  
Protection rating: IP-20



RTP-1RN/m/00 1110  
Temperature regulator with aerial sensor



RTP-1R/m/00\* 1109  
Temperature regulator with underfloor sensor

## Electronic movement detector

Screw terminals  
Rated voltage: 230V  
Rated current:  
- incandescent 3200W  
- fluorescent 750W  
- inductive 750W  
Protection rating: IP-20  
Way of adjustment the time of transmitter's switching on: 3s. – 5min.  
Angle of movement detection's field: 136°  
Field of activity: 7m



ŁP-16R/m/00 1108  
Electronic movement detector

## Equipotential sockets



GPE-1R/m/00\* 1398  
Single equipotential socket



GPE-2R/m/00\* 1399  
Twin equipotential socket



WKE\* 1571  
Plug into the equipotential socket

## Flush mounting socket, British standard

Screw terminals,  
Rated voltage: 250V  
Rated current: 13A,  
Protection rating: IP-20



GP-1RZPBS/m/00 1149  
Single socket with ground, with shutters

## Triple socket EURO

Screw terminals  
Rated voltage: 250V  
Rated current: 2,5A  
Protection rating: IP-20



GP-3R/m/00 1090  
Triple socket EURO



GP-3RP/m/00 1090  
Triple socket EURO with shutters

\* on request

Available colours

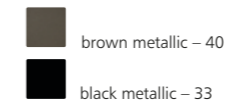
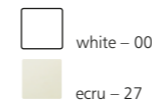

www.ospel.com.pl

## Flush mounting socket outlets

Screw terminals  
Rated voltage: 250V  
Rated current: 16A,  
Protection rating: IP-20



GP-1R/m/00 1079  
Single socket



GP-1RZP/m/00 1080  
Single socket with ground, with shutters



GP-1RZD/m/00 1081  
Single socket with ground DATA



GPH-1RZ/m/00/d 1083  
Hermetic socket with ground, IP-44



GPH-1RSP/m/00/d 1084  
Hermetic socket with ground schuko, IP-44, with shutters

Hermetic sockets in white and ecru colours are also offered with lid in product's colour. After right product's code write: .../00/w for products in white colour or .../27/w for products in ecru colour.



GP-1RP/m/00 1079  
Single socket with shutters



GP-1RS/m/00 1082  
Single socket with ground schuko



GP-1RZP/m/00 1081  
Single socket with ground DATA, with shutters



GPH-1RZP/m/00/d 1083  
Hermetic socket with ground, IP-44, with shutters



GP-1RZ/m/00 1080  
Single socket with ground



GP-1RSP/m/00 1082  
Single socket with ground schuko, with shutters



GP-1RZK/m/00 1128  
Single socket with ground DATA, with access key



GPH-1RS/m/00/d 1084  
Hermetic socket with ground schuko, IP-44

## Single socket with ground with USB charger

Screwless terminals, Rated voltage: input: 230V~50Hz, output: 5VDC  
Rated current: 2,1A, Protection rating: IP-20



GP-1RZPUSB/m/00 2059  
Single socket with ground with USB charger



GP-1RSPUSB/m/00 2060  
Single socket with ground schuko with USB charger

# SERIES Sonata

flush-mounted series



www.ospel.com.pl

Available colours

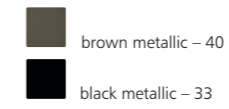

## Flush mounting socket outlets

Screw terminals  
Rated voltage: 250V  
Rated current: 16A  
Protection rating: IP-20



GP-2RR/m/00  
Twin socket 1087



GP-2RRP/m/00  
Twin socket with shutters 1087



GP-2RRZ/m/00  
Twin socket with ground 1088



GP-2RRZP/m/00  
Twin socket with ground, with shutters 1088



GP-2R/00  
Twin socket 1085



GP-2RZ/00  
Twin socket with ground 1086



GP-2RS/00  
Twin socket with ground schuko 1089



GP-2RC/00  
Twin socket with ground, without changing phase 1091



GP-2RP/00  
Twin socket with shutters 1085



GP-2RZP/00  
Twin socket with ground, with shutters 1086



GP-2RSP/00  
Twin socket with ground schuko, with shutters 1089

## Flush mounting socket outlets (sold entire)

Screw terminals  
Rated voltage: 250V  
Rated current: 16A  
Protection rating: IP-20

## Antenna subscribers

Screw terminals



GPA-1RF/m/00  
Gniazdo antenowe typu F, pojedyncze 1097



GPA-2RF/m/00  
Gniazdo antenowe typu F, podwójne 1377



GPA-10RP/m/00\*  
Through antenna RTV subscriber 10 dB 1092

GPA-14RP/m/00\*  
Through antenna RTV subscriber 14 dB 1092

GPA-16RP/m/00\*  
Through antenna RTV subscriber 16 dB 1092



GPA-10RPZ/m/00\*  
Through antenna RTV subscriber 1092



GPA-RK/m/00  
Terminal antenna RTV subscriber 1093



GPA-RS/m/00  
Terminal antenna RTV-SAT subscriber 1094



GPA-RSP/m/00\*  
Through antenna RTV-SAT subscriber 1095



GPA-R2S/m/00  
Terminal antenna RTV-SAT subscriber with two outlets SAT 1096



GPA-RD/m/00\*  
Terminal antenna RTV-DATA subscriber 1386

## Telephone socket

Screw terminals



GPT-1R/m/00  
Single telephone socket 1098



GPT-2RN/m/00  
Twin telephone socket, independent 1099

GPT-2RR/m/00  
Twin telephone socket, parallel 1099

## Blank cover



Z-1R/m/00  
Blank cover 1127

\* on request

# SERIES Sonata

flush-mounted series



www.ospel.com.pl

## Loudspeaker sockets



GG-1R/m/00  
Single loudspeaker socket  
connection of lines ability 0,75 mm<sup>2</sup>

1105



GG-2R/m/00  
Twin loudspeaker socket  
connection of lines ability 0,75 mm<sup>2</sup>

1106



GGN-1R/m/00  
Single loudspeaker socket  
connection of lines ability 6 mm<sup>2</sup>

1144

## Computer sockets

Connection IDC



GPK-1R/K/m/00  
Single computer socket,  
5e class, MMC

1100



GPK-2R/K/m/00  
Twin computer socket,  
5e class, MMC

1101

## Adapter

It allows to use of Ospel 45 system products in the Sonata series.

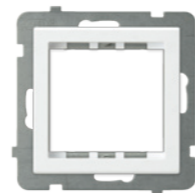

AP45-1R/m/00  
Adapter

1147

## Sockets covers Keystone type



GPK-1RS/p/00  
Single computer socket cover,  
slant

1366



GPK-2RS/p/00  
Twin computer socket cover,  
slant

1367



GPK-1R/p/00  
Single computer socket cover,  
flat

1392



GPK-2R/p/00  
Twin computer socket cover,  
flat

1393

## Cable terminal

Screw terminals, 5x4mm<sup>2</sup>  
Protection rating: IP-20  
Flush-mounted into ø60 boxes



GPPK-1R/m/00  
Cable terminal

1140

Available colours

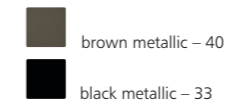

## Surrounds Standard

white



- R-1R/00 Single surround 1112
- R-2R/00 Twin surround 1113
- R-3R/00 Threefold surround 1114
- R-4R/00 Fourfold surround 1115
- R-5R/00 Fivefold surround 1116

ecru



- R-1R/27 Single surround 1112
- R-2R/27 Twin surround 1113
- R-3R/27 Threefold surround 1114
- R-4R/27 Fourfold surround 1115
- R-5R/27 Fivefold surround 1116

## Surrounds Metallic

black metallic



- R-1R/33 Single surround 1112
- R-2R/33 Twin surround 1113
- R-3R/33 Threefold surround 1114
- R-4R/33 Fourfold surround 1115
- R-5R/33 Fivefold surround 1116

gold

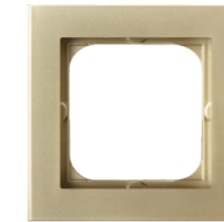

- R-1R/39 Single surround 1112
- R-2R/39 Twin surround 1113
- R-3R/39 Threefold surround 1114
- R-4R/39 Fourfold surround 1115
- R-5R/39 Fivefold surround 1116

silver

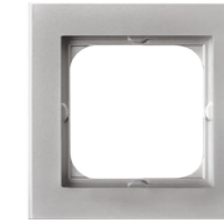

- R-1R/38 Single surround 1112
- R-2R/38 Twin surround 1113
- R-3R/38 Threefold surround 1114
- R-4R/38 Fourfold surround 1115
- R-5R/38 Fivefold surround 1116

brown metallic



- R-1R/40 Single surround 1112
- R-2R/40 Twin surround 1113
- R-3R/40 Threefold surround 1114
- R-4R/40 Fourfold surround 1115
- R-5R/40 Fivefold surround 1116

Presented surrounds are universal, the products can be mounted in horizontal and vertical position.



# SERIES Sonata

flush-mounted series



www.ospel.com.pl

Available colours

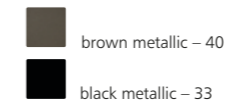

## Surrounds Standard for sets IP-44

## Surrounds Metallic for sets IP-44

white



RH-1R/00 Single surround	1112
RH-2R/00 Twin surround	1113
RH-3R/00 Threefold surround	1114
RH-4R/00 Fourfold surround	1115
RH-5R/00 Fivefold surround	1116

ecru



RH-1R/27 Single surround	1112
RH-2R/27 Twin surround	1113
RH-3R/27 Threefold surround	1114
RH-4R/27 Fourfold surround	1115
RH-5R/27 Fivefold surround	1116

black metallic



RH-1R/33 Single surround	1112
RH-2R/33 Twin surround	1113
RH-3R/33 Threefold surround	1114
RH-4R/33 Fourfold surround	1115
RH-5R/33 Fivefold surround	1116

gold



RH-1R/39 Single surround	1112
RH-2R/39 Twin surround	1113
RH-3R/39 Threefold surround	1114
RH-4R/39 Fourfold surround	1115
RH-5R/39 Fivefold surround	1116

silver



RH-1R/38 Single surround	1112	
RH-2R/38 Twin surround	1113	
RH-3R/38 Threefold surround	1114	
RH-4R/38 Fourfold surround	1115	
RH-5R/38 Fivefold surround	1116	

brown metallic



RH-1R/40 Single surround	1112	
RH-2R/40 Twin surround	1113	
RH-3R/40 Threefold surround	1114	
RH-4R/40 Fourfold surround	1115	
RH-5R/40 Fivefold surround	1116	

## Surrounds Prestige

size - 6 mm

white glass



R-1RG/31 Single surround	1112
R-2RG/31 Twin surround	1113
R-3RG/31 Threefold surround	1114
R-4RG/31 Fourfold surround	1115

wood



R-1RW/34 Single surround	1112
R-2RW/34 Twin surround	1113
R-3RW/34 Threefold surround	1114
R-4RW/34 Fourfold surround	1115

black glass

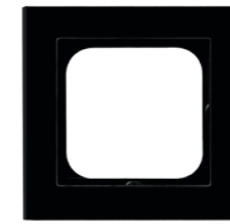

R-1RG/32 Single surround	1112
R-2RG/32 Twin surround	1113
R-3RG/32 Threefold surround	1114
R-4RG/32 Fourfold surround	1115

aluminium

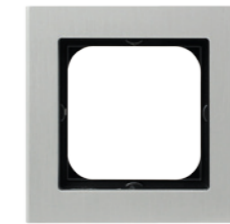

R-1RA/35 Single surround	1112
R-2RA/35 Twin surround	1113
R-3RA/35 Threefold surround	1114
R-4RA/35 Fourfold surround	1115

stone



R-1RK/36 Single surround	1112	
R-2RK/36 Twin surround	1113	
R-3RK/36 Threefold surround	1114	
R-4RK/36 Fourfold surround	1115	

Presented surrounds are universal, the products can be mounted in horizontal and vertical position.

# SERIES Sonata

flush-mounted series



www.ospel.com.pl

Available colours

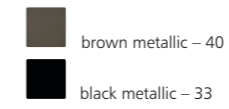

## Surrounds Prestige

size - 4 mm

white glass + white surround



- |                    |      |
|--------------------|------|
| R-1RGC/31/00       | 1112 |
| Single surround    |      |
| R-2RGC/31/00       | 1113 |
| Twin surround      |      |
| R-3RGC/31/00       | 1114 |
| Threefold surround |      |
| R-4RGC/31/00       | 1115 |
| Fourfold surround  |      |

black glass + black surround

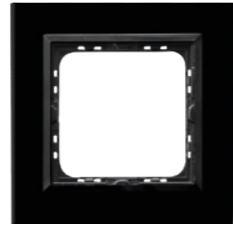

- |                    |      |
|--------------------|------|
| R-1RGC/32/25       | 1112 |
| Single surround    |      |
| R-2RGC/32/25       | 1113 |
| Twin surround      |      |
| R-3RGC/32/25       | 1114 |
| Threefold surround |      |
| R-4RGC/32/25       | 1115 |
| Fourfold surround  |      |

grey glass + black surround

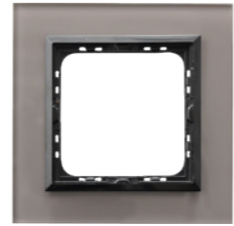

- |                    |      |  |
|--------------------|------|--|
| R-1RGC/41/25       | 1112 |  |
| Single surround    |      |  |
| R-2RGC/41/25       | 1113 |  |
| Twin surround      |      |  |
| R-3RGC/41/25       | 1114 |  |
| Threefold surround |      |  |
| R-4RGC/41/25       | 1115 |  |
| Fourfold surround  |      |  |

lime glass + white surround



- |                    |      |
|--------------------|------|
| R-1RGC/60/00       | 1112 |
| Single surround    |      |
| R-2RGC/60/00       | 1113 |
| Twin surround      |      |
| R-3RGC/60/00       | 1114 |
| Threefold surround |      |
| R-4RGC/60/00       | 1115 |
| Fourfold surround  |      |

plum glass + black surround



- |                    |      |
|--------------------|------|
| R-1RGC/61/25       | 1112 |
| Single surround    |      |
| R-2RGC/61/25       | 1113 |
| Twin surround      |      |
| R-3RGC/61/25       | 1114 |
| Threefold surround |      |
| R-4RGC/61/25       | 1115 |
| Fourfold surround  |      |

aluminium + silver surround



- |                    |      |  |
|--------------------|------|--|
| R-1RAC/35/38       | 1112 |  |
| Single surround    |      |  |
| R-2RAC/35/38       | 1113 |  |
| Twin surround      |      |  |
| R-3RAC/35/38       | 1114 |  |
| Threefold surround |      |  |
| R-4RAC/35/38       | 1115 |  |
| Fourfold surround  |      |  |

brushed aluminium + black surround

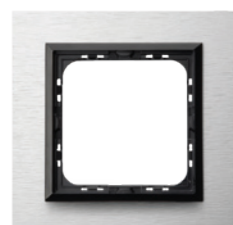

- |                    |      |
|--------------------|------|
| R-1RAC/62/25       | 1112 |
| Single surround    |      |
| R-2RAC/62/25       | 1113 |
| Twin surround      |      |
| R-3RAC/62/25       | 1114 |
| Threefold surround |      |
| R-4RAC/62/25       | 1115 |
| Fourfold surround  |      |

brushed satin + black surround



- |                    |      |
|--------------------|------|
| R-1RAC/63/25       | 1112 |
| Single surround    |      |
| R-2RAC/63/25       | 1113 |
| Twin surround      |      |
| R-3RAC/63/25       | 1114 |
| Threefold surround |      |
| R-4RAC/63/25       | 1115 |
| Fourfold surround  |      |

brushed anthracite + black surround

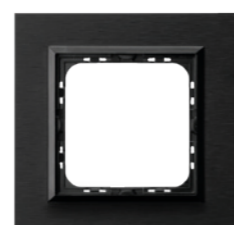

- |                    |      |  |
|--------------------|------|--|
| R-1RAC/64/25       | 1112 |  |
| Single surround    |      |  |
| R-2RAC/64/25       | 1113 |  |
| Twin surround      |      |  |
| R-3RAC/64/25       | 1114 |  |
| Threefold surround |      |  |
| R-4RAC/64/25       | 1115 |  |
| Fourfold surround  |      |  |

## Wall frames



- |                      |      |  |
|----------------------|------|--|
| PNP-1R/00            | 1133 |  |
| Single wall frame    |      |  |
| PNP-2R/00            | 1134 |  |
| Twin wall frame      |      |  |
| PNP-3R/00            | 1135 |  |
| Threefold wall frame |      |  |



- |                        |      |  |
|------------------------|------|--|
| PNP-2RN/00             | 1148 |  |
| Twin corner wall frame |      |  |

# SERIES Sonata

flush-mounted series



www.ospel.com.pl

## Available colours



White – nr 00



Ecu – nr 27



Silver – nr 38



Gold – nr 39



Brown metallic – nr 40



Black metallic – nr 33

## Available colours



white – 00



ecru – 27



brown metallic – 40

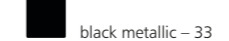

black metallic – 33



silver – 38



gold – 39

## Examples of colour combinations



White glass – nr 31



Black glass – nr 32



Grey glass – nr 41/25



White glass – nr 31/00



Black glass – nr 32/25



Lime glass – nr 60/00



Plum glass – nr 61/25



Aluminium – nr 35/38



Aluminium – nr 35



Brushed aluminium – nr 62/25



Brushed satin – nr 63/25



Brushed anthracite – nr 64/25

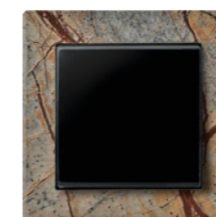

Stone – nr 36



Wood – nr 34

# SERIES Sonata

flush-mounted series

## Example order



ŁP-1R/m/00

R-1R/00

To order single pole switch in white colour must be ordered:  
ŁP-1R/m/00  
R-1R/00

To order black single pole switch with built-in light with aluminium surround must be ordered:  
ŁP-1RS/m/33  
R-1RA/35

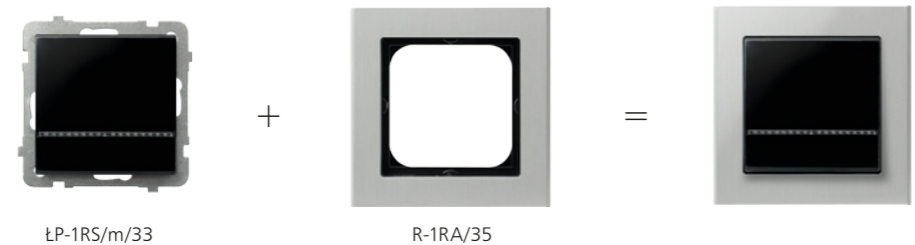

ŁP-1RS/m/33

R-1RA/35

To order single pole switch in ecru colour must be ordered:  
ŁP-1R/m/27  
R-1R/27

To order all-or-part switch, chandelier with wood surround must be ordered:  
ŁP-2R/m/33  
R-1RW/34

To order two-way switch with white glass surround must be ordered:  
ŁP-3R/m/00  
R-1RG/31

To order black single socket, with stone surround must be ordered:  
GP-1R/m/33  
R-1RK/36

To order twin socket with black glass surround must be ordered:  
GP-2RR/m/00  
R-1RG/32

Available colours



www.ospel.com.pl

## Designations

Products of SONATA series (\*excluding a few twin sockets) in all colours are sold without external surround. Below are written designations which must be used to place the order.

After right product's code write the right number of colour:  
white – number 00  
ecru – number 27  
black metallic – number 33  
silver – number 38  
gold – number 39  
brown metallic – number 40

ŁP-.....R/m	switches – in the place marked by dots, write the right number of switch	GP-3R/m	triple socket EURO
ŁP-.....RS/m	switches with built-in light – in the place marked by dots, write the right number of switch	GP-3RP/m	triple socket EURO with shutters
ŁP-8R/m	push-turn dimmer adapted to incandescent and halogen loading	GPT-1R/m	single telephone socket
ŁP-8RL2/m	universal dimmer	GPT-2RN/m	twin telephone socket, independent
ŁP-15RS/m	hotel switch	GPT-2RR/m	twin telephone socket, parallel
ŁP-16R/m	electronic movement detector	GPA-1RF/m	single antenna RTV subscriber type F
GP-1R/m	single socket	GPA-2RF/m	twin antenna RTV subscriber type F
GP-1RP/m	single socket with shutters	GPA-RK/m	terminal antenna RTV subscriber
GP-1RZ/m	single socket with ground	GPA-10RPZ/m	through antenna RTV subscriber (on request)
GP-1RZP/m	single socket with ground, with shutters	GPA-10RP/m	through antenna RTV subscriber, 10 dB (on request)
GP-1RS/m	single socket with ground schuko	GPA-14RP/m	through antenna RTV subscriber, 14 dB (on request)
GP-1RSP/m	single socket with ground schuko, with shutters	GPA-16RP/m	through antenna RTV subscriber, 16 dB (on request)
GP-1RZD/m	single socket with ground DATA	GPA-RS/m	terminal antenna RTV-SAT subscriber
GP-1RZDP/m	single socket with ground DATA, with shutters	GPA-RSP/m	through antenna RTV-SAT subscriber (on request)
GP-1RZK/m	single socket with ground DATA, with access key	GPA-R2S/m	terminal antenna RTV-SAT subscriber with two outlets SAT
GPH-1RZ/m	hermetic socket with ground IP-44	GPA-RD/m	terminal antenna RTV-DATA subscriber (on request)
GPH-1RZP/m	hermetic socket with ground IP-44, with shutters	GG-1R/m	single loudspeaker socket
GPH-1RS/m	hermetic socket with ground schuko, IP-44	GG-2R/m	twin loudspeaker socket
GPH-1RSP/m	hermetic socket with ground schuko, IP-44, with shutters	GGN-1R/m	single loudspeaker socket
GP-1RZPUSB/m	single socket with ground with USB charger	GPK-1R/K/m	single computer socket, 5e class, MMC
GP-1RSPUSB/m	single socket schuko with ground with USB charger	GPK-2R/K/m	twin computer socket, 5e class, MMC
GP-2RR/m	twin socket	GPE-1R/m	single equipotential socket (on request)
GP-2RRP/m	twin socket with shutters	GPE-2R/m	twin equipotential socket (on request)
GP-2RRZ/m	twin socket with ground	GPK-1RS/p	single computer socket cover, slant
GP-2RRZP/m	twin socket with ground, with shutters	GPK-2RS/p	twin computer socket cover, slant
GP-2R	twin socket*	GPK-1R/p	single computer socket cover, flat
GP-2RP	twin socket with shutters*	GPK-2R/p	twin computer socket cover, flat
GP-2RZ	twin socket with ground*	RTP-1R/m	temperature regulator with underfloor sensor (on request)
GP-2RZP	twin socket with ground, with shutters*	RTP-1RN/m	temperature regulator with aerial sensor
GP-2RS	twin socket with ground schuko*	Z-1R/m	blank cover
GP-2RSP	twin socket with ground schuko, with shutters*	GPPK-1R/m	cable terminal
GP-2RC	twin socket without changing phase*	AP45-1R/m	adapter

# SERIES Sonata Steel INOX

flush-mounted series



www.ospel.com.pl

## Flush mounting switches with built-in light

Screwless terminals  
Rated voltage: 250V  
Rated current: 16AX  
Protection rating: IP-20



ŁP-1RMS/m/37  
Single pole switch 1150



ŁP-2RMS/m/37  
All-or-part switch, chandelier 1151



ŁP-3RMS/m/37  
Two-way switch 1152



ŁP-4RMS/m/37  
Intermediate switch 1153



ŁP-11RMS/m/37  
Double pole switch 1156



ŁP-12RMS/m/37  
Control switch 1157

Rated current: 10AX



ŁP-5RMS/m/37  
Short-circuiting switch „light” 1154



ŁP-6RMS/m/37  
Short-circuiting switch „bell” 1154



ŁP-7RMS/m/37  
Venetian blind switch 1155



ŁP-7RMS/m/37  
Venetian blind switch with mechanical lock 1180

## Dimmers

Screw terminals  
Current supply: 230V-50 Hz  
Protection rating: IP-20



ŁP-8RM/m/37  
Push-turn dimmer adapted to incandescent and halogen loading, load 40-400W 1159



ŁP-8RML2/m/37  
Universal dimmer load: GLS – 10-250W, CFL – 5-75W LED – 0-100W functions: electronic switch, “time to bed” 1179

Accessories for switches with built-in light are on page 144.

## Flush mounting socket outlets

Screw terminals  
Rated voltage: 250V  
Rated current: 16A  
Protection rating: IP-20



GP-1RM/m/37  
Single socket 1160



GP-1RMP/m/37  
Single socket with shutters 1160



GP-1RMZ/m/37  
Single socket with ground 1161



GP-1RMZP/m/37  
Single socket with ground, with shutters 1161



GP-1RMS/m/37  
Single socket with ground schuko 1164



GP-1RMSP/m/37  
Single socket with ground shuko, with shutters 1164



GP-1RMZD/m/37  
Single socket with ground DATA 1162



GP-1RMZDP/m/37  
Single socket with ground DATA, with shutters 1162



GP-1RMZK/m/37  
Single socket with ground DATA, with access key 1163

## Computer socket

Connection IDC



GPK-2RM/K/m/37  
Twin computer socket, 5e class, MMC 1169

## Telephone socket

Connection IDC



GPT-2RMN/m/37  
Twin telephone socket, independent 1167

## Sockets covers Keystone type



GPK-2RM/p/37  
Twin computer socket cover, flat 1176  
Modules which can be mounted in this socket cover are on page 95.

# SERIES Sonata Steel INOX

flush-mounted series



www.ospel.com.pl

## Antenna subscribers

Screw terminals



GPA-2RMF/m/37 1175  
Terminal antenna RTV subscriber,  
type F, twin



GPA-10RMPZ/m/37\* 1165  
Through antenna RTV subscriber



GPA-10RMP/m/37\* 1165  
Through antenna RTV subscriber 10 dB



GPA-RMK/m/37 1166  
Terminal antenna RTV subscriber



GPA-RMS/m/37 1171  
Terminal antenna RTV-SAT  
subscriber

GPA-14RMP/m/37\* 1165  
Through antenna RTV subscriber 14 dB

GPA-16RMP/m/37\* 1165  
Through antenna RTV subscriber 16 dB

## Surrounds



R-1RM/37 1112  
Single surround



R-2RM/37 1113  
Twin surround



R-3RM/37 1114  
Threefold surround



R-4RM/37 1115  
Fourfold surround



## Example order

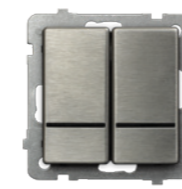

LP-2RMS/m/37

+



R-1RM/37

=



To order all-or-part switch with built-in light must be ordered:

LP-2RMS/m/37  
R-1RM/37

## Designations

Products of SONATA STEEL INOX series are sold without external surround.  
Below are written designations which must be used to place the order.  
After right product's code write number 37.

LP-...RMS/m/37	switches with built-in light - in the place marked by dots, write the right number of switch	GP-1RMZK/m/37	single socket with ground DATA, with access key
LP-8RM/m/37	push-turn dimmer adapted to incandescent and halogen loading	GPA-10RMP/m/37	through antenna RTV subscriber, 10 dB (on request)
LP-8RML2/m/37	universal dimmer	GPA-14RMP/m/37	through antenna RTV subscriber, 14 dB (on request)
GP-1RM/m/37	single socket	GPA-16RMP/m/37	through antenna RTV subscriber, 16 dB (on request)
GP-1RMP/m/37	single socket with shutters	GPA-10RMPZ/m/37	through antenna RTV subscriber (on request)
GP-1RMZ/m/37	single socket with ground	GPA-RMK/m/37	terminal antenna RTV subscriber
GP-1RMZP/m/37	single socket with ground, with shutters	GPA-2RMF/m/37	twin antenna RTV subscriber type F
GP-1RMS/m/37	single socket with ground schuko	GPA-RMS/m/37	terminal antenna RTV-SAT subscriber
GP-1RMSP/m/37	single socket with ground schuko, with shutters	GPT-2RMN/m/37	twin telephone socket, independent
GP-1RMZD/m/37	single socket with ground DATA	GPK-2RM/K/m/37	twin computer socket 5e class, MMC
GP-1RMZDP/m/37	single socket with ground DATA, with shutters	GPK-2RM/p/37	twin computer socket cover, flat

# SERIES Sonata New Silver

Products with antimicrobial copper Cu+



www.ospel.com.pl

## Flush mounting switches with built-in light

Screwless terminals  
Rated voltage: 250V  
Rated current: 16AX  
Protection rating: IP-20



ŁP-1RMS/m/44  
Single pole switch 1150



ŁP-2RMS/m/44  
All-or-part switch, chandelier 1151



ŁP-3RMS/m/44  
Two-way switch 1152



ŁP-4RMS/m/44  
Intermediate switch 1153



ŁP-11RMS/m/44  
Double pole switch 1156



ŁP-12RMS/m/44  
Control switch 1157

Rated current: 10AX



ŁP-5RMS/m/44  
Short-circuiting switch „light” 1154



ŁP-6RMS/m/44  
Short-circuiting switch „bell” 1154



ŁP-7RMS/m/44  
Venetian blind switch 1155

## Dimmers

Screw terminals  
Current supply: 230V-50 Hz  
Protection rating: IP-20



ŁP-8RM/m/44  
Push-turn dimmer adapted to incandescent and halogen loading load: 40-400W 1159



ŁP-8RML2/m/44  
Universal dimmer load: GLS – 10-250W, CFL – 5-75W LED – 0-100W functions: electronic switch, “time to bed” 1179



ŁP-7RMS/m/44  
Venetian blind switch with mechanical lock 1180

Accessories for switches with built-in light are on page 144.

## Flush mounting socket outlets

Screw terminals  
Rated voltage: 250V  
Rated current: 16A  
Protection rating: IP-20



GP-1RM/m/44  
Single socket 1160



GP-1RMP/m/44  
Single socket with shutters 1160



GP-1RMZ/m/44  
Single socket with ground 1161



GP-1RMZP/m/44  
Single socket with ground, with shutters 1161



GP-1RMS/m/44  
Single socket with ground schuko 1164



GP-1RMSP/m/44  
Single socket with ground schuko' with shutters 1164



GP-1RMZD/m/44  
Single socket with ground DATA 1162



GP-1RMZDP/m/44  
Single socket with ground DATA, with shutters 1162



GP-1RMZK/m/44  
Single socket with ground DATA, with access key 1163

## Computer socket

Connection IDC



GPK-2RM/K/m/44  
Twin computer socket, 5e class, MMC 1169

## Telephone socket

Connection IDC



GPT-2RMN/m/44  
Twin telephone socket, independent 1167

## Sockets covers Keystone type



GPK-2RM/p/44  
Twin computer socket cover, flat 1176

Modules which can be mounted in this socket cover are on page 95.

\* on request

# SERIES Sonata New Silver

Products with antimicrobial copper Cu+



www.ospel.com.pl

## Antenna subscribers

Screw terminals



GPA-2RMF/m/44 1175  
Terminal antenna RTV subscriber,  
type F, twin



GPA-10RMPZ/m/44\* 1165  
Through antenna RTV subscriber



GPA-10RMP/m/44\* 1165  
Through antenna RTV subscriber 10 dB



GPA-14RMP/m/44\* 1165  
Through antenna RTV subscriber 14 dB

GPA-16RMP/m/44\* 1165  
Through antenna RTV subscriber 16 dB



GPA-RMK/m/44 1166  
Terminal antenna RTV subscriber

GPA-RMS/m/44 1171  
Terminal antenna RTV-SAT subscriber

## Surrounds



R-1RM/44 1112  
Single surround



R-2RM/44 1113  
Twin surround



R-3RM/44 1114  
Threefold surround



R-4RM/44 1115  
Fourfold surround



## Example order



LP-1RMS/m/44

+

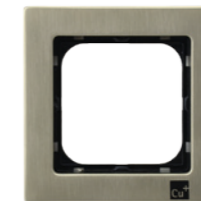

R-1RM/44

=



To order all-or-part switch with built-in light must be ordered:

LP-1RMS/m/44  
R-1RM/44

## Designations

Products of SONATA NEW SILVER series are sold without external surround.  
Below are written designations which must be used to place the order.  
After right product's code write number 44.

LP-...RMS/m/44	switches with built-in light - in the place marked by dots, write the right number of switch	GP-1RMZDP/m/44	single socket with ground DATA, with shutters
LP-8RM/m/44	push-turn dimmer adapted to incandescent and halogen loading	GP-1RMZK/m/44	single socket with ground DATA, with access key
LP-8RML2/m/44	universal dimmer	GPA-10RMP/m/44	through antenna RTV subscriber, 10 dB (on request)
GP-1RM/m/44	single socket	GPA-14RMP/m/44	through antenna RTV subscriber, 14 dB (on request)
GP-1RMP/m/44	single socket with shutters	GPA-16RMP/m/44	through antenna RTV subscriber, 16 dB (on request)
GP-1RMZ/m/44	single socket with ground	GPA-10RMPZ/m/44	through antenna RTV subscriber (on request)
GP-1RMZP/m/44	single socket with ground, with shutters	GPA-RMK/m/44	terminal antenna RTV subscriber
GP-1RMS/m/44	single socket with ground schuko,	GPA-2RMF/m/44	twin antenna RTV subscriber type F
GP-1RMSP/m/44	single socket with ground schuko, with shutters	GPA-RMS/m/44	terminal antenna RTV-SAT subscriber
GP-1RMZD/m/44	single socket with ground DATA	GPT-2RMN/m/44	twin telephone socket, independent
		GPK-2RM/K/m/44	twin computer socket 5e class, MMC
		GPK-2RM/p/44	twin computer socket cover, flat



# SERIES Sonata New Silver

Products with antimicrobial copper Cu+



# SERIES Impresja



Series Impresja is characterized by understated elegance, unobtrusive shapes and sophisticated design.

*It offers many possibilities of interior's arrangement because of the wide range of colours.*

# SERIES Impresja

flush-mounted series

Available colours

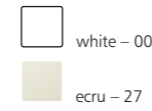

www.ospel.com.pl

## Flush mounting switches

Screwless terminals  
Rated voltage: 250V  
Rated current: 16AX  
Protection rating: IP-20



ŁP-1Y/m/00 1001  
Single pole switch



ŁP-3Y/m/00 1003  
Two-way switch



ŁP-2Y/m/00 1002  
All-or-part switch, chandelier



ŁP-4Y/m/00 1004  
Intermediate switch



ŁP-11Y/m/00 1007  
Double pole switch

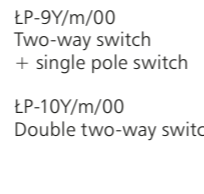

ŁP-9Y/m/00 1009  
Two-way switch + single pole switch

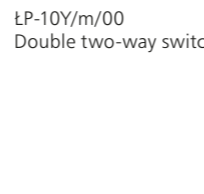

ŁP-10Y/m/00 1010  
Double two-way switch

Rated current: 10AX



ŁP-5Y/m/00 1005  
Short-circuiting switch „light”



ŁP-6Y/m/00 1005  
Short-circuiting switch „bell”



ŁP-7Y/m/00 1006  
Venetian blind switch



ŁP-7YB/m/00 2008  
Venetian blind switch with mechanical lock



ŁP-13Y/m/00 1129  
Triple switch



ŁP-17Y/m/00 1260  
Double short-circuiting switch

## Accessories for switches IP-44

There is a possibility to mount switches with protection rating IP-20 as switches with IP-44, to do that, must be bought sealing set presented below.

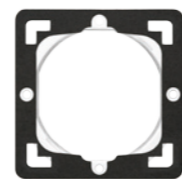

ZU-1Y 1056  
Sealing set for switches IP-44

## Flush mounting switches with built-in light

Screwless terminals  
Rated voltage: 250V  
Rated current: 16AX  
Protection rating: IP-20



ŁP-1YS/m/00 1001  
Single pole switch



ŁP-2YS/m/00 1002  
All-or-part switch, chandelier



ŁP-3YS/m/00 1003  
Two-way switch



ŁP-4YS/m/00 1004  
Intermediate switch



ŁP-11YS/m/00 1007  
Double pole switch



ŁP-12YS/m/00 1008  
Control switch

Rated current: 10AX



ŁP-5YS/m/00 1005  
Short-circuiting switch „light”



ŁP-6YS/m/00 1005  
Short-circuiting switch „bell”



ŁP-7YS/m/00 1006  
Venetian blind switch



ŁP-7YBS/m/00 2008  
Venetian blind switch with mechanical lock

## Hotel switch

Screw terminals  
Current supply: 230~ 50Hz  
Protection rating: IP-20  
Rated current: 16A  
Time of delay: 3 sec.

Switch works with a standard card with dimensions 86 x 54 x 0.8 mm



ŁP-15YS/m/00 1041  
Hotel switch

Accessories for switches with built-in light are on page 144.

# SERIES Impresja

flush-mounted series



www.ospel.com.pl

Available colours

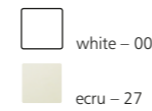

## Dimmers

Screw terminals  
Current supply: 230V ~50Hz  
Protection rating: IP-20



LP-8Y/m/00 1011  
Push-turn dimmer adapted to incandescent and halogen loading, load 40-400W



LP-8YL2/m/00 2005  
Universal dimmer load: GLS - 10-250W, CFL - 5-75W LED - 0-100W functions: electronic switch, "time to bed"

## Temperature regulators

Screw terminals,  
Rated voltage: 230V  
Rated current:  
- incandescent 3200W  
- inductive 750W  
Protection rating: IP-20



RTP-1YN/m/00 1044  
Temperature regulator with aerial sensor



RTP-1Y/m/00\* 1043  
Temperature regulator with underfloor sensor

## Triple socket EURO

Screw terminals  
Rated voltage: 250V  
Rated current: 2,5A  
Protection rating: IP-20



GP-3Y/m/00 1025  
Triple socket EURO

## Electronic movement detector

Screw terminals  
Rated voltage: 230V  
Rated current:  
- incandescent 3200W,  
- fluorescent 750W  
- inductive 750W  
Protection rating: IP-20  
Way of adjustment the time of transmitter's switching on: 3s. - 5min.  
Angle of movement detection's field: 136°  
Field of activity: 7m



LP-16Y/m/00 1042  
Electronic movement detector

## Equipotential sockets



GPE-1Y/m/00\* 1396  
Single equipotential socket



GPE-2Y/m/00\* 1397  
Twin equipotential socket



WKE\* 1571  
Plug into the equipotential socket

## Flush mounting socket outlets

Screw terminals  
Rated voltage: 250V  
Rated current: 16A  
Protection rating: IP-20



GP-1Y/m/00 1013  
Single socket



GP-1YZP/m/00 1014  
Single socket with ground, with shutters



GP-1YZD/m/00 1015  
Single socket with ground DATA



GPH-1YZ/m/00/d 1018  
Hermetic socket with ground, IP-44



GPH-1YSP/m/00/d 1019  
Hermetic socket with ground schuko, IP-44, with shutters

Hermetic sockets in white and ecru colours are also offered with lid in product's colour. After right product's code write: .../00/w for products in white colour or .../27/w for products in ecru colour.



GP-1YP/m/00 1013  
Single socket with shutters



GP-1YS/m/00 1017  
Single socket with ground schuko



GP-1YZDP/m/00 1015  
Single socket with ground DATA, with shutters



GPH-1YZP/m/00/d 1018  
Hermetic socket with ground, IP-44, with shutters

## Single socket with ground with USB charger

Screwless terminals, Rated voltage: input: 230V~50Hz, output: 5VDC  
Rated current: 2,1A, Protection rating: IP-20



GP-1YZPUSB/m/00 2066  
Single socket with ground with USB charger



GP-1YZ/m/00 1014  
Single socket with ground



GP-1YSP/m/00 1017  
Single socket with ground schuko, with shutters



GP-1YZK/m/00 1016  
Single socket with ground DATA, with access key



GPH-1YS/m/00/d 1019  
Hermetic socket with ground schuko, IP-44

# SERIES Impresja

flush-mounted series

## Flush mounting socket outlets for Standard surrounds

Screw terminals  
Rated voltage: 250V  
Rated current: 16A  
Protection rating: IP-20



GP-2YR/m/00  
Twin socket

1022



GP-2YRP/m/00  
Twin socket with shutters

1022



GP-2YRZ/m/00  
Twin socket with ground

1023



GP-2YRZP/m/00  
Twin socket with ground,  
with shutters

1023

## Flush mounting socket outlets for Prestige surrounds

Screw terminals  
Rated voltage: 250V  
Rated current: 16A  
Protection rating: IP-20



GP-2YRAZ/m/00  
Twin socket with ground

1023



GP-2YRAZP/m/00  
Twin socket with ground with shutters

1023

Available colours

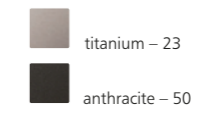

www.ospel.com.pl

## Flush mounting socket outlets (sold entire)

Screw terminals  
Rated voltage: 250V  
Rated current: 16A  
Protection rating: IP-20



GP-2Y/00  
Twin socket

1020



GP-2YP/00  
Twin socket with shutters

1020



GP-2YZ/00  
Twin socket with ground

1021



GP-2YZP/00  
Twin socket with ground,  
with shutters

1021



GP-2YS/00  
Twin socket with ground schuko

1024



GP-2YSP/00  
Twin socket with ground  
schuko, with shutters

1024



GP-2YC/00  
Twin socket with ground,  
without changing phase

1026

## Blank cover



Z-1Y/m/00  
Blank cover

1066

## Cable terminal

Screw terminals, 5x4mm<sup>2</sup>  
Protection rating: IP-20  
Flush-mounted into ø60 boxes



GPPK-1Y/m/00  
Cable terminal

1139

# SERIES Impresja

flush-mounted series



www.ospel.com.pl

Available colours

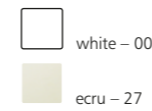

## Antenna subscribers

Screw terminals



GPA-1YF/m/00 1031  
Single, terminal antenna RTV subscriber, type F



GPA-10YPZ/m/00\* 1027  
Through antenna RTV subscriber, ZAK-10, attenuation coefficient 10 dB



GPA-YK/m/00 1028  
Terminal antenna RTV subscriber, ZAR-1



GPA-Y2S/m/00 1067  
Terminal antenna RTV-SAT subscriber, with two outlets SAT



GPA-2YF/m/00 1376  
Twin terminal antenna RTV subscriber, type F



GPA-10YP/m/00\* 1027  
Through antenna RTV subscriber, ZAP-10, attenuation coefficient 10 dB



GPA-YS/m/00 1029  
Terminal antenna RTV-SAT subscriber



GPA-YD/m/00\* 1385  
Terminal antenna RTV-DATA subscriber

## Telephone socket

Screw terminals



GPT-1Y/m/00 1032  
Single telephone socket



GPT-2YN/m/00 1033  
Twin telephone socket, independent



GPT-2YR/m/00 1033  
Twin telephone socket, parallel

## Computer sockets

Connection IDC



GPK-1Y/K/m/00 1034  
Single computer socket, 5e class, MMC



GPK-2Y/K/m/00 1035  
Twin computer socket, 5e class, MMC

## Loudspeaker sockets



GG-1Y/m/00 1039  
Single loudspeaker socket connection of lines ability 0,75 mm<sup>2</sup>



GG-2Y/m/00 1040  
Twin loudspeaker socket connection of lines ability 0,75 mm<sup>2</sup>



GGN-1Y/m/00 1145  
Single loudspeaker socket connection of lines ability 6 mm<sup>2</sup>

## Adapter

It allows to use of Ospel 45 system products in the Impresja series.

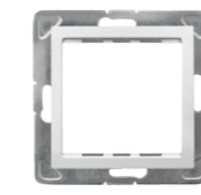

AP45-1Y/m/00 2057  
Adapter

## Sockets covers Keystone type



GPK-1YS/p/00 1368  
Single computer socket cover, slant



GPK-1Y/p/00 1390  
Single computer socket cover, flat



GPK-2YS/p/00 1369  
Twin computer socket cover, slant



GPK-2Y/p/00 1391  
Twin computer socket cover, flat

Modules which can be mounted in these socket covers are on page 95.

## Wall frames



PNP-1Y/00 1051  
Single wall frame

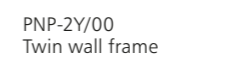

PNP-2Y/00 1052  
Twin wall frame

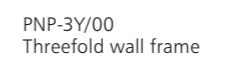

PNP-3Y/00 1053  
Threefold wall frame



PNP-4Y/00 1054  
Fourfold wall frame



PNP-5Y/00 1055  
Fivefold wall frame

\* on request

# SERIES Impresja

flush-mounted series

Available colours



www.ospel.com.pl

## Surrounds Standard

## Surrounds Metallic

white



R-1Y/00 Single surround	1046
R-2Y/00 Twin surround	1047
R-3Y/00 Threefold surround	1048
R-4Y/00 Fourfold surround	1049
R-5Y/00 Fivefold surround	1050

ecru



R-1Y/27 Single surround	1046
R-2Y/27 Twin surround	1047
R-3Y/27 Threefold surround	1048
R-4Y/27 Fourfold surround	1049
R-5Y/27 Fivefold surround	1050

silver

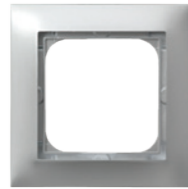

R-1Y/18 Single surround	1046
R-2Y/18 Twin surround	1047
R-3Y/18 Threefold surround	1048
R-4Y/18 Fourfold surround	1049
R-5Y/18 Fivefold surround	1050

titanium



R-1Y/23 Single surround	1046
R-2Y/23 Twin surround	1047
R-3Y/23 Threefold surround	1048
R-4Y/23 Fourfold surround	1049
R-5Y/23 Fivefold surround	1050

gold metallic



R-1Y/28 Single surround	1046	
R-2Y/28 Twin surround	1047	
R-3Y/28 Threefold surround	1048	
R-4Y/28 Fourfold surround	1049	
R-5Y/28 Fivefold surround	1050	

anthracite



R-1Y/50 Single surround	1046	
R-2Y/50 Twin surround	1047	
R-3Y/50 Threefold surround	1048	
R-4Y/50 Fourfold surround	1049	
R-5Y/50 Fivefold surround	1050	

Presented surrounds are universal, the products can be mounted in horizontal and vertical position.

## Surrounds Standard for sets IP-44

## Surrounds Metallic for sets IP-44

white



RH-1Y/00 Single surround	1046
RH-2Y/00 Twin surround	1047
RH-3Y/00 Threefold surround	1048
RH-4Y/00 Fourfold surround	1049
RH-5Y/00 Fivefold surround	1050

ecru



RH-1Y/27 Single surround	1046
RH-2Y/27 Twin surround	1047
RH-3Y/27 Threefold surround	1048
RH-4Y/27 Fourfold surround	1049
RH-5Y/27 Fivefold surround	1050

silver

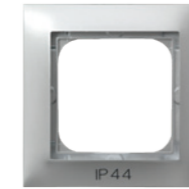

RH-1Y/18 Single surround	1046
RH-2Y/18 Twin surround	1047
RH-3Y/18 Threefold surround	1048
RH-4Y/18 Fourfold surround	1049
RH-5Y/18 Fivefold surround	1050

titanium



RH-1Y/23 Single surround	1046
RH-2Y/23 Twin surround	1047
RH-3Y/23 Threefold surround	1048
RH-4Y/23 Fourfold surround	1049
RH-5Y/23 Fivefold surround	1050

gold metallic



RH-1Y/28 Single surround	1046	
RH-2Y/28 Twin surround	1047	
RH-3Y/28 Threefold surround	1048	
RH-4Y/28 Fourfold surround	1049	
RH-5Y/28 Fivefold surround	1050	

anthracite



RH-1Y/50 Single surround	1046	
RH-2Y/50 Twin surround	1047	
RH-3Y/50 Threefold surround	1048	
RH-4Y/50 Fourfold surround	1049	
RH-5Y/50 Fivefold surround	1050	

Presented surrounds are universal, the products can be mounted in horizontal and vertical position.

# SERIES Impresja

flush-mounted series



www.ospel.com.pl

Available colours



## Surrounds Prestige

brushedaluminium + black surround

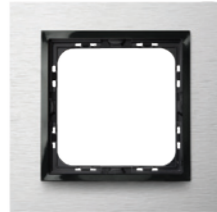

- R-1YAC/62/25 Single surround 1046
- R-2YAC/62/25 Twin surround 1047
- R-3YAC/62/25 Threefold surround 1048
- R-4YAC/62/25 Fourfold surround 1049

brushed satin + black surround



- R-1YAC/63/25 Single surround 1046
- R-2YAC/63/25 Twin surround 1047
- R-3YAC/63/25 Threefold surround 1048
- R-4YAC/63/25 Fourfold surround 1049

brushed anthracite + black surround

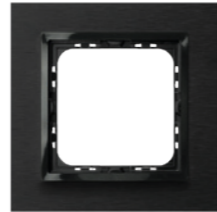

- R-1YAC/64/25 Single surround 1046
- R-2YAC/64/25 Twin surround 1047
- R-3YAC/64/25 Threefold surround 1048
- R-4YAC/64/25 Fourfold surround 1049



white glass + white surround



- R-1YGC/31/00 Single surround 1046
- R-2YGC/31/00 Twin surround 1047
- R-3YGC/31/00 Threefold surround 1048
- R-4YGC/31/00 Fourfold surround 1049

grey glass + black surround



- R-1YGC/41/25 Single surround 1046
- R-2YGC/41/25 Twin surround 1047
- R-3YGC/41/25 Threefold surround 1048
- R-4YGC/41/25 Fourfold surround 1049

black glass + black surround

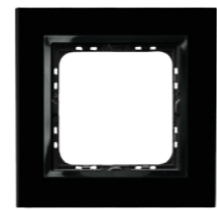

- R-1YGC/32/25 Single surround 1046
- R-2YGC/32/25 Twin surround 1047
- R-3YGC/32/25 Threefold surround 1048
- R-4YGC/32/25 Fourfold surround 1049



lime glass + white surround



- R-1YGC/60/00 Single surround 1046
- R-2YGC/60/00 Twin surround 1047
- R-3YGC/60/00 Threefold surround 1048
- R-4YGC/60/00 Fourfold surround 1049

plum glass + black surround

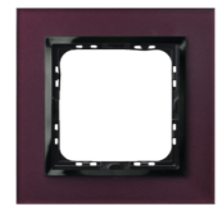

- R-1YGC/61/25 Single surround 1046
- R-2YGC/61/25 Twin surround 1047
- R-3YGC/61/25 Threefold surround 1048
- R-4YGC/61/25 Fourfold surround 1049

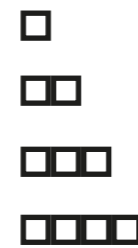

## Available colours



White - nr 00



Ecrú - nr 27



Silver - nr 18



Gold metallic - nr 28



Titanium - nr 23



Anthracite - nr 50

## Examples of colour combinations



Brushed aluminium - nr 62/25

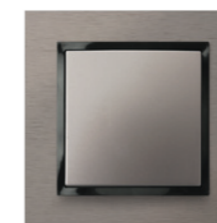

Brushed satin - nr 63/25



Brushed anthracite - nr 64/25



White glass - nr 31/00

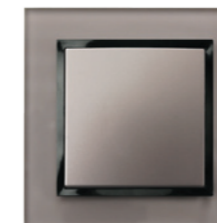

Grey glass - nr 41/25



Black glass - nr 32/25



Lime glass - nr 60/00



Plum glass - nr 61/25

# SERIES Impresja

flush-mounted series

## Example order



ŁP-1Y/m/00

R-1Y/00

To order single pole switch in white colour must be ordered:

ŁP-1Y/m/00  
R-1Y/00

To order single pole switch in ecru colour must be ordered:

ŁP-1Y/m/27  
R-1Y/27

To order two-way switch in silver colour must be ordered:

ŁP-3Y/m/18  
R-1Y/18

## Designations

Products of IMPRESJA series (\*excluding a few twin sockets) in all colours are sold without external surround. Below are written designations which must be used to place the order.

After right product's code write the right number of colour

ŁP-.....Y/m	switches - in the place marked by dots, write the right number of switch
ŁP-.....YS/m	switches with built-in light - in the place marked by dots, write the right number of switch
ŁP-8Y/m	push-turn dimmer adapted to incandescent and halogen loading
ŁP-8YL2/m	universal dimmer
ŁP-15YS/m	hotel switch
ŁP-16Y/m	electronic movement detector
GP-1Y/m	single socket
GP-1YP/m	single socket with shutters
GP-1YZ/m	single socket with ground
GP-1YZP/m	single socket with ground, with shutters
GP-1YS/m	single socket with ground schuko
GP-1YSP/m	single socket with ground schuko, with shutters
GP-1YZD/m	single socket with ground DATA
GP-1YZDP/m	single socket with ground DATA, with shutters
GP-1YZK/m	single socket with ground DATA, with access key
GPH-1YZ/m	hermetic socket with ground IP-44
GPH-1YZP/m	hermetic socket with ground IP-44, with shutters
GPH-1YS/m	hermetic socket with ground schuko, IP-44
GPH-1YSP/m	hermetic socket with ground schuko, IP-44, with shutters
GP-1YZPUSB/m	single socket with ground with USB charger
GP-2YR/m	twin socket
GP-2YRP/m	twin socket with shutters
GP-2YRZ/m	twin socket with ground
GP-2YRZP/m	twin socket with ground, with shutters
GP-2YRAZ	twin socket with ground for Prestige surrounds
GP-2YRAZP	twin socket with ground, with shutters for Prestige surrounds
GP-2Y	twin socket*
GP-2YP	twin socket with shutters*
GP-2YZ	twin socket with ground*
GP-2YZP	twin socket with ground, with shutters*
GP-2YS	twin socket with ground schuko*

white – number 00  
ecru – number 27  
silver – number 18  
gold – number 28  
titanium – number 23  
anthracite – 50

GP-2YSP	twin socket with ground schuko, with shutters*
GP-2YC	twin socket without changing phase*
GP-3Y/m	triple socket euro
GPT-1Y/m	single telephone socket
GPT-2YN/m	twin telephone socket, independent
GPT-2YR/m	twin telephone socket, parallel
GPA-10YP/m	through antenna RTV subscriber ZAP-10 (on request)
GPA-14YP/m	through antenna RTV subscriber ZAP-14 (on request)
GPA-16YP/m	through antenna RTV subscriber ZAP-16 (on request)
GPA-10YPZ/m	through antenna RTV subscriber (on request)
GPA-YK/m	terminal antenna RTV subscriber ZAR-1
GPA-YS/m	terminal antenna RTV-SAT subscriber
GPA-YSP/m	through antenna RTV-SAT subscriber (on request)
GPA-Y2S/m	terminal antenna RTV-SAT subscriber with two outlets SAT
GPA-YD/m	terminal antenna RTV-DATA subscriber (on request)
GPA-1YF/m	single, terminal antenna RTV subscriber, type F
GPA-2YF/m	twin terminal antenna RTV subscriber, type F
GG-1Y/m	single loudspeaker socket
GG-2Y/m	twin loudspeaker socket
GGN-1Y/m	single loudspeaker socket
GPK-1Y/K/m	single computer socket, 5e class, MMC
GPK-2Y/K/m	twin computer socket 5e class, MMC
GPE-1Y/m	single equipotential socket (on request)
GPE-2Y/m	twin equipotential socket (on request)
GPK-1YS/p	single computer socket cover, slant
GPK-2YS/p	twin computer socket cover, slant
GPK-1Y/p	single computer socket cover, flat
GPK-2Y/p	twin computer socket cover, flat
RTP-1Y/m	temperature regulator with underfloor sensor (on request)
RTP-1YN/m	temperature regulator with aerial sensor
Z-1Y/m	blank cover
GPPK-1Y/m	cable terminal
AP45-1Y/m	adapter

# MODULES Keystone



The universal solution for OSPEL equipment, so that there is a possibility to create sets of data communications adapted to your needs.

Socket covers dedicated to these modules are available in the series: Karo, As, Sonata, Impresja and Ospel 45.



## Computer socket modules

### 5e class – UTP



MGK-K5  
Module RJ45, MMC



MGK-M5  
Module RJ45, MOLEX



MGK-K5E\*  
Module RJ45, MMC

### 6 class – UTP



MGK-K6  
Module RJ45, MMC



MGK-T6\*  
Module RJ45, FMT



MGK-M6  
Module RJ45, MOLEX

### 6 class, shielded – STP



MGK-K6E\*  
Module RJ45, MMC



MGK-K6AE\*  
Module RJ45, MMC



MGK-T6AE\*  
Module RJ45, FMT



MGK-M6AE\*  
Module RJ45, MOLEX

### 6a class, shielded – STP

## HDMI Module



MG-HDMI\*\*  
Module HDMI angular

MG-HDMIP  
Module HDMI straight

## USB Module



MG-USB  
Module USB

## Telephone socket module



MGT-K  
Module RJ12, MMC

## Antenna subscriber module



MGA-1F  
Module type F

Modules HDMI and USB work only with flat socket covers Keystone type.

## Loudspeaker socket modules



MG-MJ  
Module mini stereo Jack



MG-RCA/R  
Module RCA, red



MG-RCA/W  
Module RCA, white

## Modules



MGS-1SC  
Fiber optic adapter, type SC



MG-VGA  
Module VGA



GKV-1/p/00  
Cover of module VGA

## Blank covers



ZOK-1/25  
Blank cover of sockets covers  
Keystone type



ZOK-1/00  
Blank cover of sockets covers  
Keystone type

Presented modules have a Keystone attachment

\* doesn't work with surface mounting wall frames

\*\* for boxes Ø 60mm, depth minimum 60mm, only as single

# Gazela

SERIES



Series Gazela is a series of bold shapes and rich form. Additional inner frame adds originality.

*It is a stylish decoration of the walls thanks to the original line of curves. The proposal for the interior with courageous and resolute character.*

# SERIES Gazela

flush-mounted series



www.ospel.com.pl

Available colours



white – 00



satin – 16/16

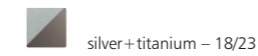

silver+titanium – 18/23

## Flush mounting switches

Screwless terminals  
Rated voltage: 250V  
Rated current: 16AX  
Protection rating: IP-20



ŁP-1J/m/00  
Single pole switch 347



ŁP-2J/m/00  
All-or-part switch, chandelier 348



ŁP-3J/m/00  
Two-way switch 349

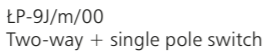

ŁP-9J/m/00  
Two-way + single pole switch 353

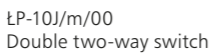

ŁP-10J/m/00  
Double two-way switch 355



ŁP-4J/m/00  
Intermediate switch 350



ŁP-11J/m/00  
Double pole switch 357

Rated current: 10AX



ŁP-5J/m/00  
Short-circuiting switch „light” 351



ŁP-6J/m/00  
Short-circuiting switch „bell” 351



ŁP-7J/m/00  
Venetian blind switch 352



ŁP-17J/m/00  
Double short-circuiting switch 1261



ŁP-13J/m/00  
Triple switch 356

## Flush mounting switches with built-in light

Screwless terminals  
Rated voltage: 250V  
Rated current: 16AX  
Protection rating: IP-20



ŁP-1JS/m/00  
Single pole switch 347



ŁP-2JS/m/00  
All-or-part switch, chandelier 348



ŁP-3JS/m/00  
Two-way switch 349



ŁP-4JS/m/00  
Intermediate switch 350



ŁP-11JS/m/00  
Double pole switch 357



ŁP-12JS/m/00  
Control switch 358

Rated current: 10AX



ŁP-5JS/m/00  
Short-circuiting switch „light” 351



ŁP-6JS/m/00  
Short-circuiting switch „bell” 351



ŁP-7JS/m/00  
Venetian blind switch 352

Accessories for switches with built-in light are on page 144.

## Accessories for switches IP-44

There is a possibility to mount switches with protection rating IP-20 as switches with IP-44, to do that must be bought sealing set presented below.

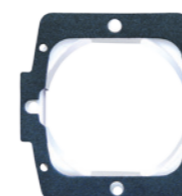

ZU-1J  
Sealing set for switches IP 44 359



ROH-1J/00  
Decorative, fixing surround for switches IP-44 359

## Hotel switch,

Screw terminals  
Current supply: 230~ 50Hz  
Protection rating: IP-20  
Rated current: 16A  
Time of delay: 3 sec.

Switch works with a standard card with dimensions 86 x 54 x 0.8 mm



ŁP-15JS/m/00  
Hotel switch 512

# SERIES Gazela

flush-mounted series



www.ospel.com.pl

Available colours

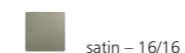

## Temperature regulator

Screw terminals  
Rated voltage: 230V  
Rated current:  
- incandescent 3200W  
- inductive 750W  
Underfloor sensor  
Protection rating: IP-20



RTP-1J/m/00\*  
Temperature regulator

509

\* on request

## Electronic movement detector

Screw terminals  
Rated voltage: 230V  
Rated current:  
- incandescent 3200W  
- fluorescent 750W, - inductive 750W  
Protection rating: IP-20  
Way of adjustment the time of transmitter's switching on: 3s–5min.  
Angle of movement detection's field: 136°  
Field of activity: 7m



ŁP-16J/m/00  
Electronic movement detector

510

## Triple socket EURO

Screw terminals  
Rated voltage: 250V  
Rated current: 2,5A  
Protection rating: IP-20



GP-3J/m/00  
Triple socket EURO

577

## Push-turn dimmers

Screw terminals  
Current supply: 230V–50Hz  
Load: 60–400W  
Protection rating: IP-20



ŁP-8JA/m/00  
Push-turn dimmer adapted to incandescent and loading,

399



ŁP-8JB/m/00  
Push-turn dimmer adapted to incandescent and halogen loading

399

## Loudspeaker sockets

Connection of lines ability 0,75 mm<sup>2</sup>



GG-1J/m/00  
Single loudspeaker socket

395



GG-2J/m/00  
Twin loudspeaker socket

395

## Flush mounting socket outlets

Screwless terminals  
Rated voltage: 250V  
Rated current: 16A  
Protection rating: IP-20



GP-1J/m/00  
Single socket

375



GP-1JP/m/00  
Single socket with shutters

375



GP-1JZ/m/00  
Single socket with ground

376



GP-1JZP/m/00  
Single socket with ground, with shutters

376



GP-1JS/m/00  
Single socket with ground schuko

377



GP-1JSP/m/00  
Single socket with ground schuko, with shutters

377



GP-1JZD/m/00  
Single socket with ground DATA

381



GP-1JZDP/m/00  
Single socket with ground DATA, with shutters

381



GP-1JGZK/m/00  
Single socket with ground DATA, with access key

505



GPH-1JZ/m/00/d  
Hermetic socket with ground, IP-44

378



GPH-1JZP/m/00/d  
Hermetic socket with ground, IP-44, with shutters

378



GPH-1JS/m/00/d  
Hermetic socket with ground schuko, IP-44

379



GPH-1JSP/m/00/d  
Hermetic socket with ground schuko, IP-44, with shutters

379

# SERIES Gazela

flush-mounted series



www.ospel.com.pl

Available colours



white - 00



satin - 16/16



silver+titanium - 18/23

## Flush mounting socket outlets

Screw terminals  
Rated voltage: 250V  
Rated current: 16A  
Protection rating: IP-20



GP-2J/00  
Twin socket 382



GP-2JP/00  
Twin socket with shutters 382



GP-2JZ/00  
Twin socket with ground 383



GP-2JZP/00  
Twin socket with ground, with shutters 383



GP-2JS/00  
Twin socket with ground schuko 384



GP-2JSP/00  
Twin socket with ground schuko, with shutters 384

## Telephone socket

Screw terminals



GPT-1J/m/00  
Single telephone socket, 389



GPT-2JN/m/00  
Twin telephone socket, independent 390

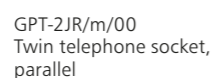

GPT-2JR/m/00  
Twin telephone socket, parallel 390

## Computer sockets

Connection IDC



GPK-1J/K/m/00  
Single computer socket, 5e class, MMC 391

GPK-1J/F/m/00  
Single computer socket, 5e class, FOREX 391

GPK-1J/K6/m/00  
Single computer socket, 6 class, MMC 589

GPK-1J/K6E/m/00  
Single computer socket, 6 class shielded MMC 589



GPK-2J/K/m/00  
Twin computer socket, 5e class, MMC 393

GPK-2J/F/m/00  
Twin computer socket, 5e class, FOREX 393

GPK-2J/K6/m/00  
Twin computer socket, 6 class, MMC 590

GPK-2J/K6E/m/00  
Twin computer socket, 6 class shielded, MMC 590



GPKT-J/K/m/00  
Conjoint computer and telephone socket, MMC 394

GPKT-J/F/m/00  
Conjoint computer and telephone socket, FOREX 394

GPKT-J/K6/m/00  
Conjoint computer (6 class) and telephone socket, MMC 591

GPKT-J/K6E/m/00  
Conjoint computer (6 class, shielded) and telephone socket, MMC 591

## Antenna subscribers

Screw terminals



GPA-1JF/m/00  
Terminal antenna RTV subscriber, type F, single 618



GPA-10JP/m/00\*  
Through antenna RTV subscriber 10 dB 386

GPA-14JP/m/00\*  
Through antenna RTV subscriber 14 dB 386

GPA-16JP/m/00\*  
Through antenna RTV subscriber 16 dB 386



GPA-2JF/m/00  
Terminal antenna RTV subscriber, type F, twin 619



GPA-10JPZ/m/00\*  
Through antenna RTV subscriber 386



GPA-JK/m/00  
Terminal antenna RTV subscriber 2,5-3 dB 388



GPA-JS/m/00  
Terminal antenna RTV-SAT subscriber 1,5-2 dB 387

GPA-JSP/m/00\*  
Through antenna RTV-SAT subscriber 1,2 dB 583



GPA-J2S/m/00  
Terminal antenna RTV-SAT subscriber, with two outlets SAT 605

\* on request

# SERIES Gazela

flush-mounted series



www.ospel.com.pl

## Surrounds

Offered in horizontal and vertical version  
H – horizontal surround, V – vertical surround

white	beige	satin
		
R-1J/00 Single surround	R-1J/01 Single surround	R-1J/16 Single surround
404	404	404
		
R-2JH/00 R-2JV/00 Twin surround	R-2JH/01 R-2JV/01 Twin surround	R-2JH/16 R-2JV/16 Twin surround
410	410	410
		
R-3JH/00 R-3JV/00 Threefold surround	R-3JH/01 R-3JV/01 Threefold surround	R-3JH/16 R-3JV/16 Threefold surround
411	411	411
		
R-4JH/00 R-4JV/00 Fourfold surround	R-4JH/01 R-4JV/01 Fourfold surround	R-4JH/16 R-4JV/16 Fourfold surround
412	412	412
		
R-5JH/00 Fivefold surround	R-5JH/01 Fivefold surround	R-5JH/16 Fivefold surround
491	491	491
silver	beige	
		
R-1J/18 Single surround	RG-1J/01 Surround for twin sockets	382
404	Surround for twin sockets offered in colours: 00 - white, 01 - beige, 16 - satin and 18 - silver.	
		
R-2JH/18 R-2JV/18 Twin surround		
410		
		
R-3JH/18 R-3JV/18 Threefold surround		
411		
		
R-4JH/18 R-4JV/18 Fourfold surround		
412		
		
R-5JH/18 Fivefold surround		
491		

After right code of surround write the right number of wanted colour.

Available colours



white – 00











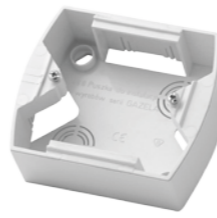

satin – 16/16

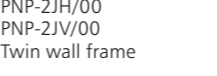

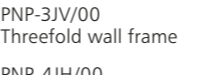
silver+titanium – 18/23

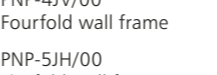
## Wall frames

Offered in horizontal and vertical version  
H – horizontal wall frame, V – vertical wall frame

	PNP-1J/00 Single wall frame	498	
	PNP-2JH/00 PNP-2JV/00 Twin wall frame	518 518	
	PNP-3JH/00 PNP-3JV/00 Threefold wall frame	519 519	
	PNP-4JH/00 PNP-4JV/00 Fourfold wall frame	520 520	
	PNP-5JH/00 Fivefold wall frame	522	

## Available colours



ŁP-1JS/00 White



ŁP-1JS/16/16 Satin + Satin



ŁP-1JS/18/23 Silver + Titanium

## Example order



ŁP-1J/m/00

+



R-1J/00

=



To order single pole switch in white colour must be ordered:  
ŁP-1J/m/00  
R-1J/00

# SERIES Gazela

flush-mounted series

## Designations

Products of GAZELA series (\*excluding a few twin sockets) in all colours are sold without external surround. Below are written designations which must be used to place the order.

After right product's code write the right number of colour  
white - number 00  
satin - number 16/16  
silver+titanium - number 18/23.

ŁP-.....J/m/00	switches - in the place marked by dots, write the right number of switch	GPT-2JR/m/00	twin telephone socket, parallel
ŁP-.....JS/m/00	switches with built-in light - in the place marked by dots, write the right number of switch	GPA-JK/m/00	terminal antenna RTV subscriber
ŁP-8J.../m/00	push-turn dimmer adapted to incandescent and halogen loading	GPA-10JPZ/m/00	through antenna RTV subscriber (on request)
ŁP-15JS/m/00	hotel switch	GPA-10JP/m/00	through antenna RTV subscriber, 10 dB (on request)
ŁP-16J/m/00	electronic movement detector	GPA-14JP/m/00	through antenna RTV subscriber, 14 dB (on request)
GP-1J/m/00	single socket	GPA-16JP/m/00	through antenna RTV subscriber, 16 dB (on request)
GP-1JP/m/00	single socket with shutters	GPA-JS/m/00	terminal antenna RTV-SAT subscriber
GP-1JZ/m/00	single socket with ground	GPA-JSP/m/00	through antenna RTV-SAT subscriber (on request)
GP-1JZP/m/00	single socket with ground, with shutters	GPA-J2S/m/00	terminal antenna RTV-SAT subscriber with two outlets SAT
GP-1JS/m/00	single socket with ground schuko	GG-1J/m/00	single loudspeaker socket
GP-1JSP/m/00	single socket with ground schuko, with shutters	GG-2J/m/00	twin loudspeaker socket
GP-1JZD/m/00	single socket with ground DATA	GPK-1J/K/m/00	single computer socket, 5e class, MMC
GP-1JZDP/m/00	single socket with ground DATA, with shutters	GPK-1J/F/m/00	single computer socket, 5e class, FOREX
GP-1JGZK/m/00	single socket with ground DATA, z kluczem	GPK-1J/K6/m/00	single computer socket, 6 class, MMC
GPH-1JZ/m/00/d	hermetic socket with ground IP-44	GPK-1J/K6E/m/00	single computer socket, 6 class shielded, MMC
GPH-1JZP/m/00/d	hermetic socket with ground IP-44, with shutters	GPK-2J/K/m/00	twin computer socket, 5e class, MMC
GPH-1JS/m/00/d	hermetic socket with ground schuko, IP-44	GPK-2J/F/m/00	twin computer socket, 5e class, FOREX
GPH-1JSP/m/00/d	hermetic socket with ground schuko, IP-44, with shutters	GPK-2J/K6/m/00	twin computer socket, 6 class, MMC
GP-2J/00	twin socket*	GPK-2J/K6E/m/00	twin computer socket, 6 class shielded, MMC
GP-2JP/00	twin socket with shutters*	GPKT-J/K/m/00	conjunct computer and telephone socket, MMC
GP-2JZ/00	twin socket with ground*	GPKT-J/F/m/00	conjunct computer and telephone socket, FOREX
GP-2JZP/00	twin socket with ground, with shutters*	GPKT-J/K6/m/00	conjunct computer (6 class)-telephone socket, MMC
GP-2JS/00	twin socket with ground schuko*	GPKT-J/K6E/m/00	conjunct computer (6 class, shielded)-telephone socket, MMC
GP-2JSP/00	twin socket with ground schuko, with shutters*	RTP-1J/m/00	temperature regulator with underfloor sensor (on request)
GP-3J/m/00	triple socket EURO		
GPT-1J/m/00	single telephone socket		
GPT-2JN/m/00	twin telephone socket, independent		

# SERIES Ton



TON is a modern shot of retro style. Internal, decorative surrounds look interesting and chic.

Also the colour of products allows individual solutions for different interiors. In offer; metallized line, pastel line and Ton Color System.

# SERIES Ton

flush-mounted series



www.ospel.com.pl

Available colours



## Flush mounting switches

Screwless terminals  
Rated voltage: 250V  
Rated current: 10AX  
Protection rating: IP-20



ŁP-1C/00  
Single pole switch 126



ŁP-2C/00  
All-or-part switch, chandelier 127



ŁP-3C/00  
Two-way switch 128



ŁP-4C/00  
Intermediate switch 129



ŁP-5C/00  
Short-circuiting switch „light” 130



ŁP-6C/00  
Short-circuiting switch „bell” 131



ŁP-7C/00  
Venetian blind switch 132



ŁP-9C/00  
Two-way + single pole switch 469

ŁP-10C/00  
Double two-way switch 458

## Flush mounting switches with built-in light

Screwless terminals  
Rated voltage: 250V  
Rated current: 10AX  
Protection rating: IP-20



ŁP-1CS/00  
Single pole switch 133



ŁP-2CS/00  
All-or-part switch, chandelier 134



ŁP-3CS/00  
Two-way switch 135



ŁP-4CS/00  
Intermediate switch 136



ŁP-5CS/00  
Short-circuiting switch „light” 137



ŁP-6CS/00  
Short-circuiting switch „bell” 138



ŁP-7CS/00  
Venetian blind switch 139

Accessories for switches with built-in light are on page 144.

## Accessories for switches IP-44

There is a possibility to mount switches with protection rating IP-20 as switches with IP-44, to do that must be bought sealing set presented below.



ZU-1C  
Sealing set for switches IP-44 160



ROH-1C/00  
Decorative, fixing surround for switches IP-44 173

## Push-turn dimmers

Screw terminals  
Current supply: 230V-50Hz  
Load: 60-400W  
Protection rating: IP-20



ŁP-8CA/00  
Push-turn dimmer adapted to incandescent loading 192



ŁP-8CB/00  
Push-turn dimmer adapted to incandescent and halogen loading 192

## Triple socket EURO

Screw terminals  
Rated voltage: 250V  
Rated current: 2,5A  
Protection rating: IP-20



GP-3C/00  
Triple socket EURO 608



# SERIES Ton

flush-mounted series



www.ospel.com.pl

Available colours



white - 00



silver+satin - 18/16



satin+gold - 16/20

## Flush mounting socket outlets

Screw terminals  
Rated voltage: 250V  
Rated current: 16A  
Protection rating: IP-20



GP-1C/00  
Single socket 156



GP-1CP/00  
Single socket with shutters 156



GP-1CZ/00  
Single socket with ground 157



GP-1CZP/00  
Single socket with ground, with shutters 157



GP-1CS/00  
Single socket with ground schuko 187



GP-1CSP/00  
Single socket with ground schuko, with shutters 187



GP-1CZD/00  
Single socket with ground DATA 172



GP-1CZDP/00  
Single socket with ground DATA, with shutters 172



GP-1CZK/00  
Single socket with ground DATA, with access key 429



GPH-1CZ/00/d  
Hermetic socket with ground, IP-44 160



GPH-1CZP/00/d  
Hermetic socket with ground, IP-44, with shutters 160



GPH-1CS/00/d  
Hermetic socket with ground schuko, IP-44 189



GPH-1CSP/00/d  
Hermetic socket with ground schuko, IP-44, with shutters 189

## Flush mounting socket outlets

Screw terminals  
Rated voltage: 250V  
Rated current: 16A  
Protection rating: IP-20



GP-2C/00  
Twin socket 158



GP-2CP/00  
Twin socket with shutters 158



GP-2CZ/00  
Twin socket with ground 159



GP-2CZP/00  
Twin socket with ground, with shutters 159



GP-2CS/00  
Twin socket with ground schuko 188



GP-2CSP/00  
Twin socket with ground schuko, with shutters 188

# SERIES Ton

flush-mounted series

## Loudspeaker sockets

Connection of lines ability 0,75 mm<sup>2</sup>



GG-1C/00  
Single loudspeaker socket 413



GG-2C/00  
Twin loudspeaker socket 413

## Telephone socket

Screw terminals



GPT-1C/00  
Single telephone socket 161



GPT-2CN/00  
Twin telephone socket,  
independent 162

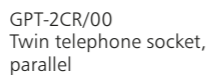

GPT-2CR/00  
Twin telephone socket,  
parallel 163

## Computer sockets

Connection IDC



GPK-1C/K/00  
Single computer socket,  
5e class, MMC 170



GPK-2C/K/00  
Twin computer socket,  
5e class, MMC 171

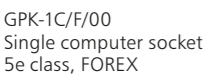

GPK-1C/F/00  
Single computer socket,  
5e class, FOREX 170

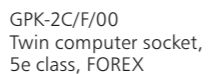

GPK-2C/F/00  
Twin computer socket,  
5e class, FOREX 171



GPKT-C/K/00 428  
Conjoint computer and telephone socket,  
MMC

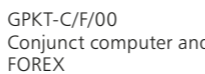

GPKT-C/F/00 428  
Conjoint computer and telephone socket,  
FOREX

Available colours

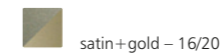

www.ospel.com.pl

## Antenna subscribers

Screw terminals



GPA-1C/00  
Single antenna RTV subscriber 487



GPA-CK/00 164  
Terminal antenna RTV subscriber 2,5-3 dB



GPA-10CP/00\* 166  
Through antenna RTV subscriber 10 dB

GPA-14CP/00\* 167  
Through antenna RTV subscriber 14 dB

GPA-16CP/00\* 168  
Through antenna RTV subscriber 16 dB



GPA-10CPZ/00\* 165  
Through antenna RTV subscriber



GPA-CS/00 169  
Terminal antenna RTV-SAT subscriber  
1,5-2 dB

GPA-CSP/00\* 582  
Through antenna RTV-SAT subscriber  
1,2 dB



GPA-C2S/00 606  
Terminal antenna RTV-SAT subscriber  
with two outlets SAT

## Surrounds

Offered in horizontal and vertical version  
H – horizontal surround,  
V – vertical surround



R-1C/00 194  
Single surround

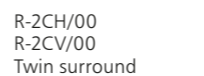

R-2CH/00 195  
R-2CV/00 196  
Twin surround

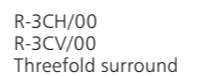

R-3CH/00 197  
R-3CV/00 198  
Threefold surround

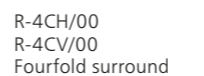

R-4CH/00 202  
R-4CV/00 576  
Fourfold surround

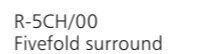

R-5CH/00 567  
Fivefold surround



## Wall frames

Offered in horizontal and vertical version  
H – horizontal wall frame,  
V – vertical wall frame



PNP-1C/00 476  
Single wall frame

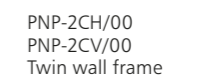

PNP-2CH/00 515  
PNP-2CV/00 515  
Twin wall frame

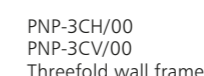

PNP-3CH/00 516  
PNP-3CV/00 516  
Threefold wall frame

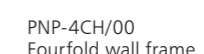

PNP-4CH/00 517  
Fourfold wall frame



\* on request

# SERIES Ton

flush-mounted series

## Available colours



White

## Metallized colours

After right product's code write the number of wanted colour, according to the presentation below.



ŁP-1C/18/16  
Silver + satin



ŁP-1C/16/20  
Satin + gold

## Pastel colours

Decorative surround offered in beige colour - 01.



Beige

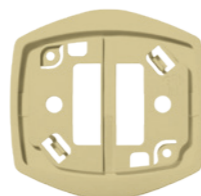

RO-1C/01  
Surround for switches

10-126-02

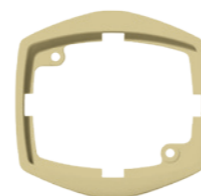

RO-2C/01  
Surround for single sockets

10-156-01



RO-3C/01  
Surround for twin sockets

10-158-02

RO-4C/01  
Surround for twin sockets schuko

10-188-03

## Ton Color System

Products of Ton series are sold without external surround, which is offered in wide range of colours.



00 white



01 beige



11 willow green



16 satin



18 silver



19 copper

To order a surround in wanted colour, in the place marked by dots, write the right number of colour according to the presentation. Presented colours can slightly differ from the original.

R-1C/..... Single surround	194	□
R-2CH/..... R-2CV/..... Twin surround horizontal/vertical	195 196	□□
R-3CH/..... R-3CV/..... Threefold surround horizontal/vertical	197 198	□□□
R-4CH/..... R-4CV/..... Fourfold surround horizontal/vertical	202 576	□□□□
R-5CH/..... Fivefold surround horizontal	567	□□□□□

## Example order below:



ŁP-1C/m/00

+



R-1C/11 willow green

=



# SERIES Ton

flush-mounted series

## Designations

Products of Ton series are sold without external surround, which is offered in wide range of colours. Below are written product's codes which should be used in order.

ŁP-.....C/m/00	switches - in the place marked by dots, write the right number of switch	GPT-1C/m/00	single telephone socket
ŁP-.....CS/m/00	switches with built-in light - in the place marked by dots, write the right number of switch	GPT-2CN/m/00	twin telephone socket, independent
ŁP-.....8CA/m/00	push-turn dimmer adapted to incandescent loading	GPT-2CR/m/00	twin telephone socket, parallel
ŁP-.....8CB/m/00	push-turn dimmer adapted to incandescent and halogen loading	GPA-1C/m/00	single antenna RTV subscriber
GP-1C/m/00	single socket	GPA-CK/m/00	terminal antenna RTV subscriber
GP-1CP/m/00	single socket with shutters	GPA-10CPZ/m/00	through antenna RTV subscriber (on request)
GP-1CZ/m/00	single socket with ground	GPA-10CP/m/00	through antenna RTV subscriber, 10 dB (on request)
GP-1CZP/m/00	single socket with ground, with shutters	GPA-14CP/m/00	through antenna RTV subscriber, 14 dB (on request)
GP-1CS/m/00	single socket with ground schuko	GPA-16CP/m/00	through antenna RTV subscriber, 16 dB (on request)
GP-1CSP/m/00	single socket with ground schuko, with shutters	GPA-CS/m/00	terminal antenna RTV-SAT subscriber
GP-1CZD/m/00	single socket with ground DATA	GPA-CSP/m/00	through antenna RTV-SAT subscriber
GP-1CZDP/m/00	single socket with ground DATA, with shutters	GPA-C2S/m/00	terminal antenna RTV-SAT subscriber with two outlets SAT
GP-1CZK/m/00	single socket with ground DATA, with access key	GG-1C/m/00	single loudspeaker socket
GPH-1CZ/m/00/d	hermetic socket with ground IP-44	GG-2C/m/00	swin loudspeaker socket
GPH-1CZP/m/00/d	hermetic socket with ground IP-44, with shutters	GPK-1C/K/m/00	single computer socket, 5e class, MMC
GPH-1CS/m/00/d	hermetic socket with ground schuko, IP-44	GPK-1C/F/m/00	single computer socket, 5e class, FOREX
GPH-1CSP/m/00/d	hermetic socket with ground schuko, IP-44, with shutters	GPK-2C/K/m/00	twin computer socket, 5e class, MMC
GP-3C/m/00	triple socket EURO	GPK-2C/F/m/00	twin computer socket, 5e class, FOREX
		GPKT-C/K/m/00	conjunct computer and telephone socket, MMC
		GPKT-C/F/m/00	conjunct computer and telephone socket, FOREX

# Akcent

SERIES



Akcent series successfully blends the sharp, geometric cut and delicate three-dimensional shape.

*High-quality materials used for the production of the series, for years translate into her popularity among installers and consumers.*

# SERIES Akcent

flush-mounted series



www.ospel.com.pl

Available colours

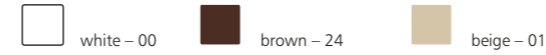

## Flush mounting switches

Screw terminals  
Rated voltage: 250V  
Rated current: 10AX  
Protection rating: IP-20



ŁP-1A/00  
Single pole switch 960

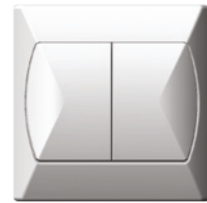

ŁP-2A/00  
All-or-part switch, chandelier 961

ŁP-9A/00  
Two-way + single pole switch 418

ŁP-10A/00  
Double two-way switch 419



ŁP-3A/00  
Two-way switch 962



ŁP-4A/00  
Intermediate switch 963



ŁP-5A/00  
Short-circuiting switch „light“ 964



ŁP-6A/00  
Short-circuiting switch „bell“ 965



ŁP-7A/00  
Venetian blind switch 190

ŁP-7AB/00  
Venetian blind switch with mechanical lock 190

## Push-turn dimmers

Screw terminals  
Current supply: 230V-50Hz  
Load: 60-400W  
Protection rating: IP-20



ŁP-8AA/00  
Push-turn dimmer adapted to incandescent loading 492



ŁP-8AB/00  
Push-turn dimmer adapted to incandescent and halogen loading 492

## Flush mounting switches with built-in light

Screw terminals  
Rated voltage: 250V  
Rated current: 10AX  
Protection rating: IP-20



ŁP-1AS/00  
Single pole switch 966

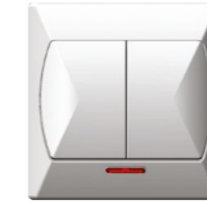

ŁP-2AS/00  
All-or-part switch, chandelier 967



ŁP-9AS/00  
Two-way + single pole switch 418

ŁP-10AS/00  
Double two-way switch 419



ŁP-3AS/00  
Two-way switch 968



ŁP-4AS/00  
Intermediate switch 969



ŁP-5AS/00  
Short-circuiting switch „light“ 970



ŁP-6AS/00  
Short-circuiting switch „bell“ 971



ŁP-7AS/00  
Venetian blind switch 191

ŁP-7ABS/00  
Venetian blind switch with mechanical lock 191

## Telephone socket

Screw terminals



GPT-1A/00  
Single telephone socket 990



GPT-2AN/00  
Twin telephone socket, independent 991

GPT-2AR/00  
Twin telephone socket, parallel 992

Accessories for switches with built-in light are on page 144.

# SERIES Akcent

flush-mounted series



www.ospel.com.pl

## Flush mounting socket outlets

Screw terminals  
Rated voltage: 250V  
Rated current: 16A  
Protection rating: IP-20



GP-1A/00  
Single socket 972



GP-1AP/00  
Single socket with shutters 972



GP-1AZ/00  
Single socket with ground 973



GP-1AZP/00  
Single socket with ground, with shutters 973



GP-1AS/00  
Single socket with ground schuko 275



GP-1ASP/00  
Single socket with ground schuko, with shutters 275



GP-1AW/00  
Single socket with plug's ejector 976



GP-1AZW/00  
Single socket with ground with plug's ejector 981



GPH-1AZ/00/d  
Hermetic socket with ground, IP-44 984



GPH-1AS/00/w  
Hermetic socket with ground schuko, IP-44 277



GPH-1ASP/00/w  
Hermetic socket with ground schuko, IP-44, with shutters 277

Available colours



white - 00



brown - 24



beige - 01

## Flush mounting socket outlets

Screw terminals  
Rated voltage: 250V  
Rated current: 16A  
Protection rating: IP-20



GP-2A/00  
Twin socket 974

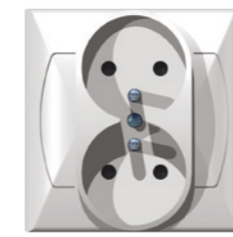

GP-2AZ/00  
Twin socket with ground 975



GP-2AS/00  
Twin socket with ground schuko 276



GP-2ASP/00  
Twin socket with ground schuko, with shutters 276



GP-2AC/00  
Twin socket with ground, without changing phase 420

## Computer sockets

Connection IDC



GPK-1A/K/00  
Single computer socket, 5e class, MMC 993



GPK-2A/K/00  
Twin computer socket, 5e class, MMC 994



GPKT-A/K/00  
Conjoint computer and telephone socket, MMC 995

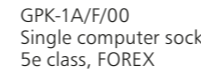

GPK-1A/F/00  
Single computer socket, 5e class, FOREX 993

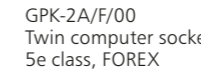

GPK-2A/F/00  
Twin computer socket, 5e class, FOREX 994

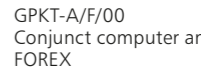

GPKT-A/F/00  
Conjoint computer and telephone socket, FOREX 995

# SERIES Akcent

flush-mounted series

## Antenna subscribers

Screw terminals



GPA-1A/00 490  
Single antenna RTV subscriber



GPA-AK/00 985  
Terminal antenna RTV subscriber 2,5-3 dB



GPA-10AP/00\* 987  
Through antenna RTV subscriber 10 dB

GPA-14AP/00\* 988  
Through antenna RTV subscriber 14 dB

GPA-16AP/00\* 989  
Through antenna RTV subscriber 16 dB



GPA-10APZ/00\* 986  
Through antenna RTV subscriber



GPA-AS/00 424  
Terminal antenna RTV-SAT subscriber 1,5-2 dB

## Available colours



ŁP-1A/00 - White



ŁP-1A/01 - Beige



ŁP-1A/24 - Brown

## Wall frames



PNP-A/00 256  
Wall frame for switches AKCENT



PNP-AG/00 257  
Wall frame for sockets AKCENT

\* on request

# Ospel 45 SERIES

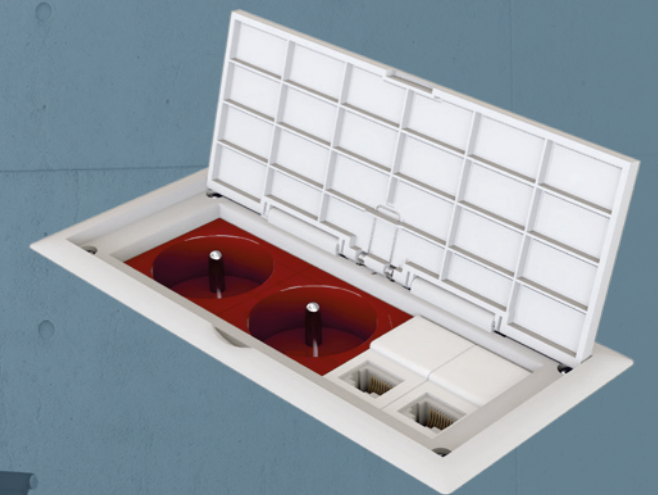

The series is dedicated to multimedia solutions, it allows to place many workplaces in conference rooms and offices in discreet way.

*It is the perfect solution for hotels or restaurants to convert dining rooms into a full-fledged room for seminars and conferences, every day without interfering with their primary function.*

# SERIES Ospel 45



www.ospel.com.pl

Available colours



## Switches

Screw terminals  
Rated voltage: 250V  
Rated current: 10AX  
Protection rating: IP-20



ŁK-1/46  
Single pole switch 1800



ŁK-3/46  
Two-way switch 1801



ŁK-5/46  
Short-circuiting switch 1802

## Switches with built-in light

Screw terminals  
Rated voltage: 250V  
Rated current: 10AX  
Protection rating: IP-20



ŁK-1S/46  
Single pole switch 1800



ŁK-3S/46  
Two-way switch 1801



ŁK-5S/46  
Short-circuiting switch 1802

## Blank cover



GKZ-1/46  
Blank cover 1814

## Flush mounting socket, British standard

Screw terminals  
Rated voltage: 250V  
Rated current: 13A  
Protection rating: IP-20



GK-1ZPBS/46  
Single socket with ground, with shutters 1822

## USB charger

Screwless terminals. Rated voltage:  
– input: 100-240~ 50/60Hz 0,2A  
– output: 5VDC  
Rated current: 2,1A  
Protection rating: IP-20



GK-2USB/46  
USB charger 1823

## Sockets

Screw terminals  
Rated voltage: 250V  
Rated current: 16A  
Protection rating: IP-20



GK-1/46\*  
Single socket 1803



GK-1P/46\*  
Single socket with shutters 1803



GK-1Z/46  
Single socket with ground 1804



GK-1ZP/46  
Single socket with ground, with shutters 1804

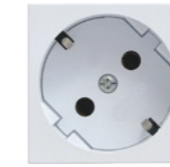

GK-1S/46  
Single socket with ground schuko 1807



GK-1SP/46  
Single socket with ground schuko, with shutters 1807

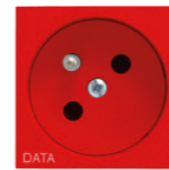

GK-1ZD/22  
Single socket with ground DATA 1805

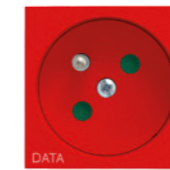

GK-1ZDP/22  
Single socket with ground DATA, with shutters 1805



GK-1ZK/22  
Single socket with ground DATA, with access key 1806

## Socket covers



GKK-1/p/46  
Socket cover Keystone type 1810



GKV-1/p/00  
Cover of module VGA 1824

Modules which can be mounted in this socket cover are on page 95.

## Loudspeaker socket



GKG-1/46  
Single loudspeaker socket 1813

## Equipotential socket



GKE-1/46  
Equipotential socket 1815

\* on request



# SERIES Ospel 45

## Boxes

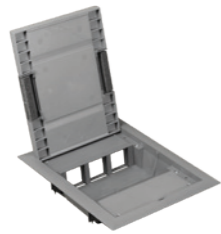

KOPOBOX 57 LB  
Frame of floor boxes



KOPOBOX 80 LB  
Frame of floor boxes

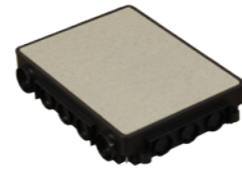

KUP 57 FB  
Universal floor box

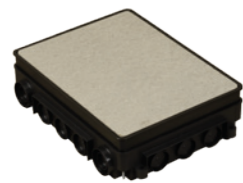

KUP 80 FB  
Universal floor box



KOPOBOX mini L HB  
Box for modular equipment,  
empty walls



KOPOBOX mini B HB  
Box for modular equipment, solid walls  
and floors



KPP 80 LB  
Floor box for equipment



PP 80/3  
Equipment's support



PP 80/45  
Equipment's support

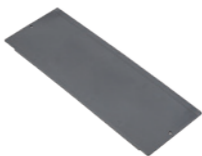

PP 80/0  
Blank cover



PKUP  
Division



ZPP  
Blank cover



SN  
Leveling kit

## Hermetic, surface-mounted boxes

Insulation resistance: 400V, Protection rating: IP-55



PNH45-1  
Single wall frame

1851



PNH45-2  
Twin wall frame

1852



PNH45-3  
Threefold wall frame

1853

# SERIES Bis



Bis is a traditional, surface-mounted series, with a casual style. The assortment provides the necessary switches and sockets.

*Ideally suited to the technical areas.*



# SERIES BIS

surface-mounted series



www.ospel.com.pl

## Surface mounting switches

Screwless terminals  
Rated voltage: 250V  
Rated current: 10AX  
Protection rating: IP-20



ŁN-1B/00  
Single pole switch 316



ŁN-2B/00  
All-or-part switch, chandelier 317



ŁN-3B/00  
Two-way switch 318



ŁN-4B/00  
Intermediate switch 319



ŁN-5B/00  
Short-circuiting switch „light” 320



ŁN-6B/00  
Short-circuiting switch „bell” 320



ŁN-7B/00  
Venetian blind switch 324

Available colours



## Surface mounting switches with built-in light

Screwless terminals  
Rated voltage: 250V  
Rated current: 10AX  
Protection rating: IP-20



ŁN-1BS/00  
Single pole switch 325



ŁN-2BS/00  
All-or-part switch, chandelier 326



ŁN-3BS/00  
Two-way switch 327



ŁN-4BS/00  
Intermediate switch 328



ŁN-5BS/00  
Short-circuiting switch „light” 330



ŁN-6BS/00  
Short-circuiting switch „bell” 330



ŁN-7BS/00  
Venetian blind switch 333

## Surface mounting socket outlets

Screw terminals  
Rated voltage: 250V  
Rated current: 16A  
Protection rating: IP-20



GN-1B/00  
Single socket 334



GN-1BP/00  
Single socket with shutters 334



GN-1BZ/00  
Single socket with ground 335



GN-1BZP/00  
Single socket with ground, with shutters 335



GN-1BS/00  
Single socket with ground schuko 339



GN-1BSP/00  
Single socket with ground schuko, with shutters 339

# SERIES BIS

surface-mounted series

## Surface mounting socket outlets

Screw terminals  
Rated voltage: 250V  
Rated current: 16A  
Protection rating: IP-20



GN-2B/00  
Twin socket

336



GN-2BP/00  
Twin socket with shutters

336



GN-2BZ/00  
Twin socket with ground

337



GN-2BZP/00  
Twin socket with ground,  
with shutters

337



GN-2BS/00  
Twin socket  
with ground schuko

340



GN-2BSP/00  
Twin socket  
with ground schuko, with shutters

340



GN-2BC/00  
Twin socket with ground,  
without changing phase

338

## Available colours



LN-1B/00 - White

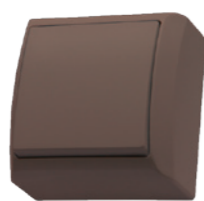

LN-1B/24 - Brown

# Madera

SERIES



Surface-mounted series with protection rating IP-44, so it can be used in areas with higher humidity or near water.

*In offer also ready-made sets, guaranteeing the security and good look.*

# SERIES Madera

surface-mounted series



www.ospel.com.pl

Available colours



## Surface mounting switches

Screw terminals  
Rated voltage: 250V  
Rated current: 10AX  
Protection rating: IP-44



ŁNH-1N/00 1270  
Single pole switch



ŁNH-2N/00 1271  
All-or-part switch, chandelier



ŁNH-3N/00 1272  
Two-way switch



ŁNH-4NS/00 1273  
Intermediate switch



ŁNH-5NS/00 1274  
Short-circuiting switch „light”



ŁNH-6NS/00 1274  
Short-circuiting switch „bell”



ŁNH-4N/00 1273  
Intermediate switch



ŁNH-5N/00 1274  
Short-circuiting switch „light”



ŁNH-6N/00 1274  
Short-circuiting switch „bell”



ŁNH-7NS/00 1275  
Venetian blind switch



ŁNH-11NS/00 1276  
Double pole switch



ŁNH-7N/00 1275  
Venetian blind switch



ŁNH-11N/00 1276  
Double pole switch

## Surface mounting switches with built-in light

Screw terminals  
Rated voltage: 250V  
Rated current: 10AX  
Protection rating: IP-44



ŁNH-1NS/00 1270  
Single pole switch



ŁNH-2NS/00 1271  
All-or-part switch, chandelier



ŁNH-3NS/00 1272  
Two-way switch

## Surface mounting socket outlets

Screw terminals  
Rated voltage: 250V  
Rated current: 16A  
Protection rating: IP-44

Hermetic sockets in white colour are also offered with lid in white colour. After right product's code write: .../00/w



GNH-1NZ/00/d 1277  
Single socket with ground



GNH-1NZP/00/d 1277  
Single socket with ground, with shutters



GNH-1NSP/00/d 1279  
Single socket with ground schuko



GNH-1NSP/00/d 1279  
Single socket with ground schuko, with shutters



GNH-2NZ/00/d 1278  
Twin socket with ground



GNH-2NZP/00/d 1278  
Twin socket with ground, with shutters

# SERIES Madera

surface-mounted series



GNH-2NS/00/d  
Twin socket with ground schuko

1280



GNH-2NSP/00/d  
Twin socket with ground schuko,  
with shutters

1280



GNH-3NZ/00/d  
Triple socket with ground

1283



GNH-3NZP/00/d  
Triple socket with ground, with shutters

1283



GNH-3NS/00/d  
Triple socket with ground schuko

1284



GNH-3NSP/00/d  
Triple socket with ground schuko,  
with shutters

1284

## Sets



ZH-NL1G/00/d  
Single pole switch + Single socket

1285



ZH-NL2G/00/d  
All-or-part switch + Single socket

1287



ZH-NL1SG/00/d  
Single pole switch with built-in light  
+ Single socket

1286



ZH-NL2SG/00/d  
All-or-part switch with built-in light  
+ Single socket

1288

# SERIES Fala



Surface-mounted series, which is the best for places where is necessary to use products with a higher protection rating IP.

Perfect for bathrooms, laundries, as well as garages or warehouses.

# SERIES Fala

surface-mounted series



www.ospel.com.pl

Available colours



## Surface mounting switches

Screw terminals  
Rated voltage: 250V  
Rated current: 10AX  
Protection rating: IP-44



ŁNH-1H/00  
Single pole switch 100



ŁNH-2H/00  
All-or-part switch, chandelier 101



ŁNH-3H/00  
Two-way switch 102



ŁNH-4H/00  
Intermediate switch 103



ŁNH-5H/00  
Short-circuiting switch „light” 104



ŁNH-6H/00  
Short-circuiting switch „bell” 105



ŁNH-7H/00  
Venetian blind switch 106



ŁNH-11H/00  
Double pole switch 425



ŁNH-4HS/00  
Intermediate switch 110



ŁNH-5HS/00  
Short-circuiting switch „light” 111



ŁNH-6HS/00  
Short-circuiting switch „bell” 112



ŁNH-7HS/00  
Venetian blind switch 113



ŁNH-11HS/00  
Double pole switch 426

## Surface mounting switches with built-in light

Screw terminals  
Rated voltage: 250V  
Rated current: 10AX  
Protection rating: IP-44



ŁNH-1HS/00  
Single pole switch 107



ŁNH-2HS/00  
All-or-part switch, chandelier 108



ŁNH-3HS/00  
Two-way switch 109

## Surface mounting socket outlets

Screw terminals  
Rated voltage: 250V  
Rated current: 16A  
Protection rating: IP-44

Hermetic sockets in white colour are also offered with lid in white colour. After right product's code write: .../00/w



GNH-1HZ/00/d  
Single socket with ground 114



GNH-1HZP/00/d  
Single socket with ground, with shutters 114



GNH-1HS/00/d  
Single socket with ground schuko 116



GNH-1HSP/00/d  
Single socket with ground schuko, with shutters 116



GNH-2HZP/00/d  
Twin socket with ground 115

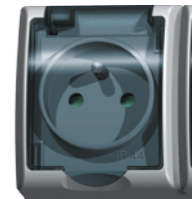

GNH-2HZP/00/d  
Twin socket with ground, with shutters 115

# SERIES Fala

surface-mounted series



GNH-2HS/00/d  
Twin socket with ground schuko

117



GNH-2HSP/00/d  
Twin socket with ground schuko,  
with shutters

117

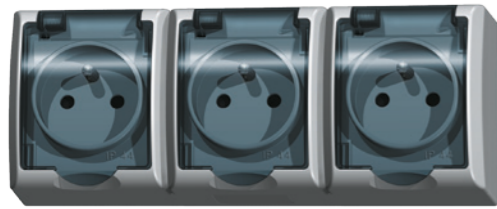

GNH-3HZ/00/d  
Triple socket with ground

460

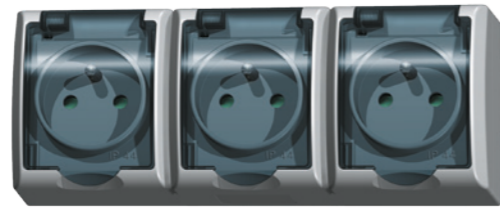

GNH-3HZP/00/d  
Triple socket with ground, with shutters

460



GNH-3HS/00/d  
Triple socket with ground schuko

865



GNH-3HSP/00/d  
Triple socket with ground schuko,  
with shutters

865

## Sets

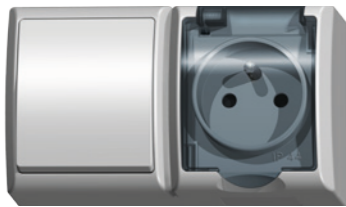

ZH-L1G/00/d  
Single socket + Single socket

122

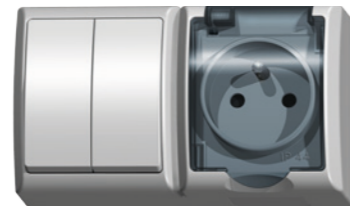

ZH-L2G/00/d  
All-or-part switch, chandelier + Single socket

123

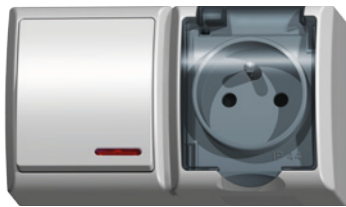

ZH-L1SG/00/d  
Single socket with built-in light  
+ Single socket

124

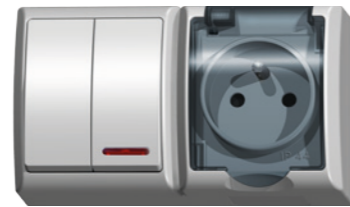

ZH-L2SG/00/d  
All-or-part switch, chandelier with built-in light  
+ Single socket

125

# SERIES Delfina



Surface-mounted series - the perfect solution for rooms exposed on contact with water or moisture.

Solid construction ensures safe use.

# SERIES Delfina

Series hermetyczna, natynkowa

Available colours produktów

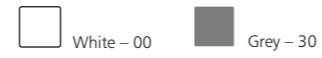

## Surface mounting switches

Screw terminals  
Rated voltage: 250V  
Rated current: 16AX  
Protection rating: IP-44



ŁNH-1D/00  
Single pole switch 900



ŁNH-2D/00  
All-or-part switch, chandelier 901



ŁNH-3D/00  
Two-way switch 902



ŁNH-4D/00  
Intermediate switch 903



ŁNH-5D/00  
Short-circuiting switch „light“ 904



ŁNH-6D/00  
Short-circuiting switch „bell“ 905

## Surface mounting socket outlets

Screw terminals  
Rated voltage: 250V  
Rated current: 16A  
Protection rating: IP-44



GNH-1DZ/00/w  
Single socket with ground 914



GNH-1DS/00/w  
Single socket with ground schuko 912



ŁNH-1D/00 White



GNH-2DZ/00/w  
Twin socket with ground 915

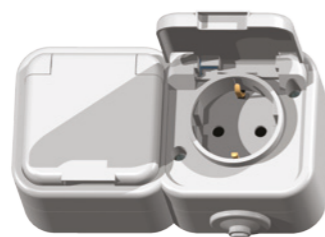

GNH-2DS/00/w  
Twin socket with ground schuko 913



ŁNH-1D/30 Grey

## Available colours

# Accessories





# Accessories

## Accessories for switches with built-in light



KS-1  
Capacitor for energy-saving  
fluorescent lamps 344



LP-1N  
Light module LTS, blue 347

LP-1P  
Light module LTS, orange 347

LP-2N  
Light module LED, blue 347

LP-2C  
Light module LED, red 347

LP-2B  
Light module LED, white 347

LP-2Z  
Light module LED, green 347

For series: Kier, Karo, As, Sonata, Impresja,  
Gazela

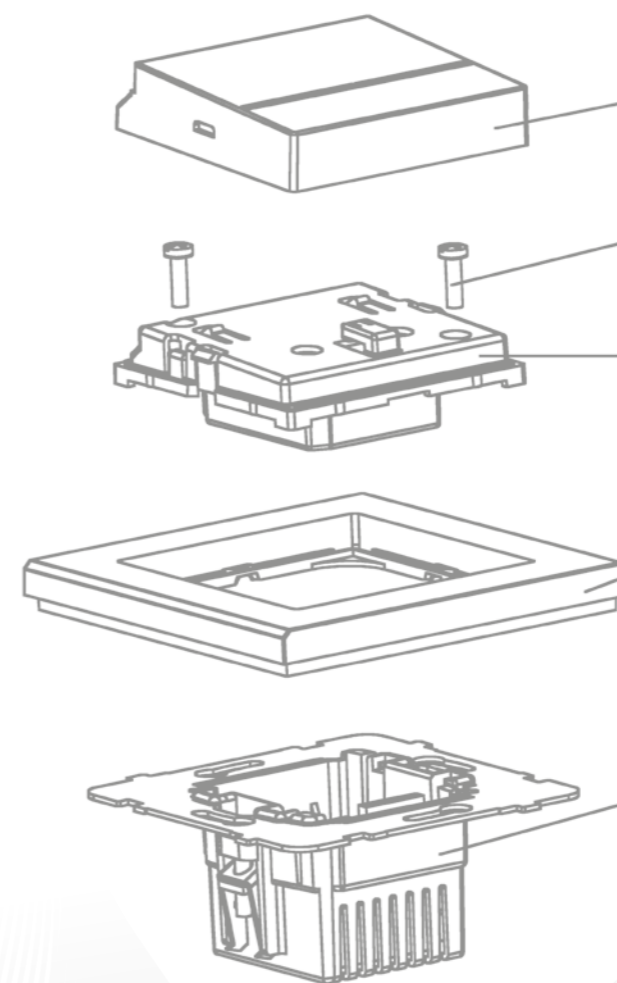

# Technical *information*

To facilitate the installation work, we present the necessary schemes.

# Diagrams of switches

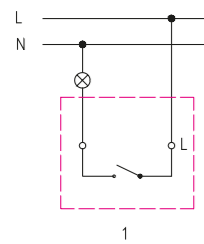

Single pole switch

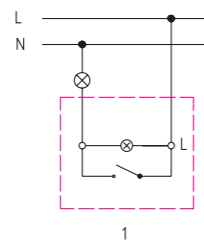

Single pole switch with built-in light

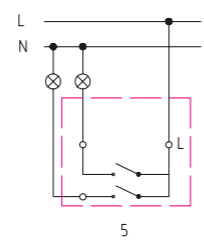

All-or-part switch, chandelier

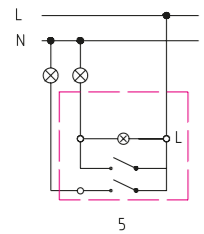

All-or-part switch with built-in light, chandelier

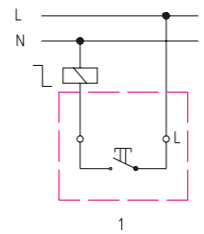

Short-circuiting switch „light” with built-in light

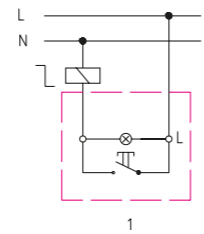

Short-circuiting switch „light” with built-in light

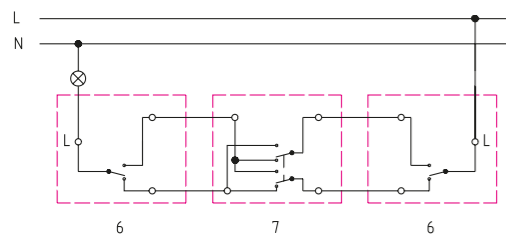

Intermediate switch (cooperation with two-way switches)

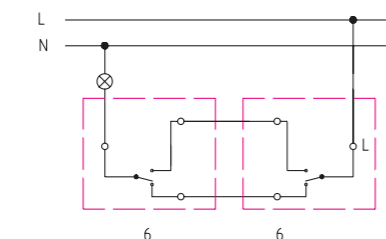

Two-way switches (cooperation)

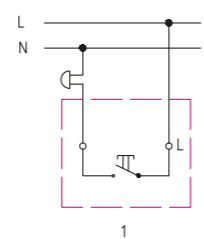

Short-circuiting switch „bell”

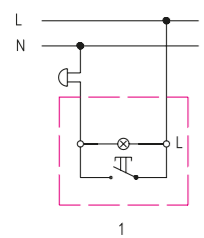

Short-circuiting switch „bell” with built-in light

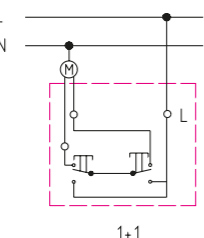

Venetian blind switch

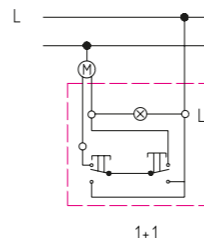

Venetian blind switch with built-in light

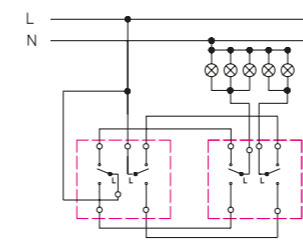

Double two-way switch

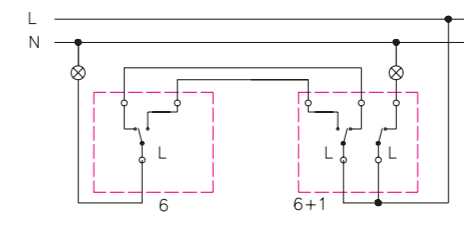

Cooperation of two-way and single pole switch with two-way switch

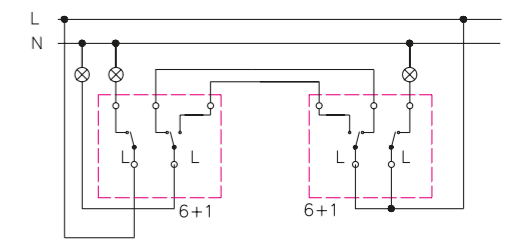

Cooperation of two-way and single pole switches

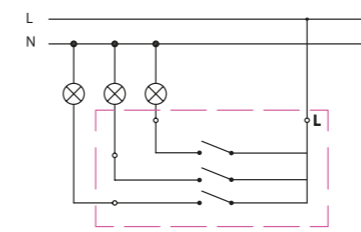

Triple switch

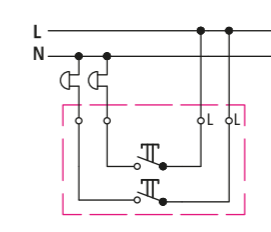

Double short-circuiting switch

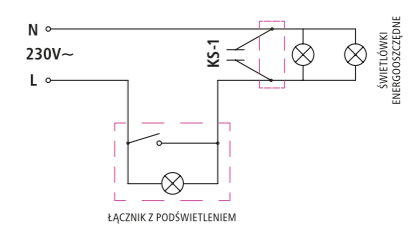

Capacitor

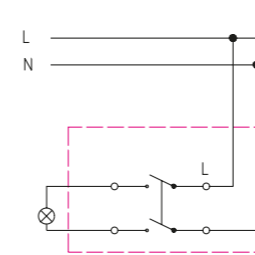

Control switch

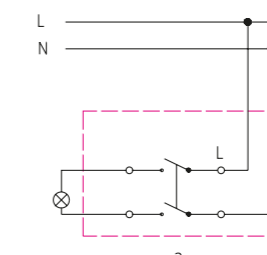

Double pole switch

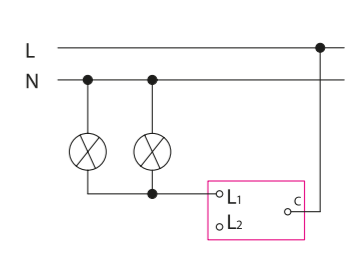

Dimmer

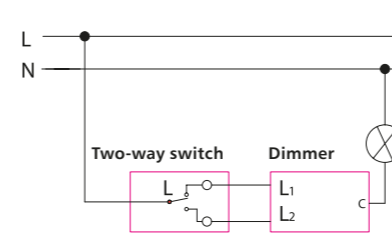

Dimmer with two-way switch

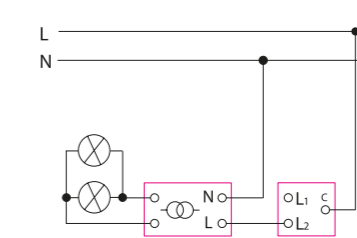

Dimmer adapted to halogen loading, with transformer

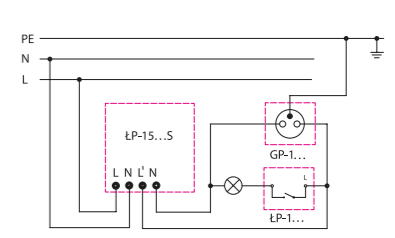

Hotel switch







**OSPEL S.A.**

ul. Główna 128, Wierbka 42-436 Pillica

tel./fax: +48 32 67 37 106-110

fax: +48 32 75 08 499

[ospel@ospel.com.pl](mailto:ospel@ospel.com.pl)

[www.ospel.com.pl](http://www.ospel.com.pl)