



# THE **NEW** CONNECTED THERMOSTAT

Smarter

WITH  
Netatmo

Essential design,  
maximum comfort,  
wherever you are.

Smarter  
WITH  
Netatmo

The BTicino connected thermostat monitors and manages the temperature of the home simply and timely. Thanks to the Home + Control App and the compatibility with voice assistants, it allows smart management of the home temperature.



BTicino connected thermostat,  
developed jointly with Netatmo, forms  
part of the Eliot by BTicino programme  
dedicated to connected objects

## DESIGN



3 colours for flush mounted version: white, black and sand

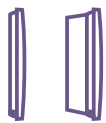

2 versions: flush mounted and wall mounted

## COMFORT AND SAVING

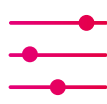

Easy heating system management and monitoring



Boost function for maximum comfort



Compatibility with Netatmo smart radiator valves for setting the desired temperature in every room

## EASE OF USE



Basic functions with local device control



Advanced functions and programming with the Home + Control App



Basic functions with local voice assistant compatible control: Siri (Apple), Google Assistant, Amazon Alexa



Other smart home functions with  
 - Living Now with Netatmo  
 - Livinglight with Netatmo

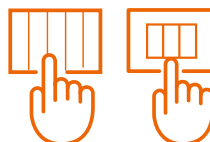



Essential design.  
Modern style.



A minimal and refined design, in which the thickness and glass-effect finish make it versatile and suitable for any style of home. The metallised detail is a distinctive element which characterises the object and becomes an informative and enhancing element of the distinctive “Boost” function. At last, its discrete white light is decorative and informative, assisting the user in understanding and using the functions.

**Smarter** WITH Netatmo

The BTicino connected thermostat was conceived for integration with all living styles, and is perfectly coordinated with the Living Now range.

**Living Now** WITH Netatmo



# Comfort and saving

What can you do with the BTicino connected thermostat?



## SETTING THE PROGRAMS

Using the Home + Control App, it is possible to set preset programs based on your habits.



## AWAY

If you need to be away from home for a few days you can, via the APP, act remotely to adjust the thermostat (e.g. in antifrost mode) independent of the automatic programming.



## BOOST

The Boost function can be used to activate the heating or cooling system for a limited time (30, 60 or 90 minutes), irrespective of the set program and the ambient temperature.

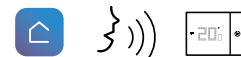

App



Voice control



Device



### MONITORING OF CONSUMPTIONS

Using the Home + Control App, it is possible to easily manage and monitor consumptions.

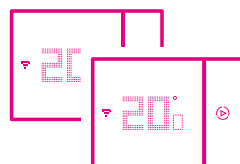

### MAXIMUM COMFORT IN EVERY ZONE

Using the same App, it is possible to manage several thermostats in the same home or in different homes, as well as set the desired temperature in every room for maximum comfort.



# Ease of use

The connected thermostat is simple and intuitive



## LOCAL DEVICE CONTROL



## VOICE CONTROL

It is also possible to manage the heating with your voice using voice control assistants.

Siri (Apple), Google Assistant, Amazon Alexa.

GOOGLE: "Set the kitchen to automatic"

AMAZON: "Alexa, increase the living room temperature by 3°C"

APPLE: "Siri, set the temperature to 20°C"



## GEOLOCATION

When used in conjunction with voice assistants, it is possible to set the geolocalisation routine, which allows you to save energy by switching off the heating when you leave the home.



Display the temperature and set it as desired



Display the set room temperature and humidity



Activate the Boost function





# Home + Control App

## With the App it's all easier

- Remotely manage the thermostat simply and intuitively
- Create and modify the weekly programs
- Manage the thermostat from several smartphones and different users
- Control several thermostats in the same home or different homes
- Manage the thermostat updates

# Home + Control App

In just a few steps you can already use the connected thermostat

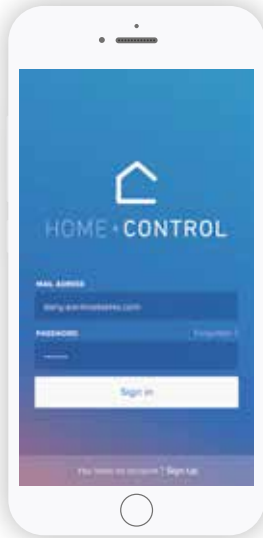

1

Download and install the Home + Control App

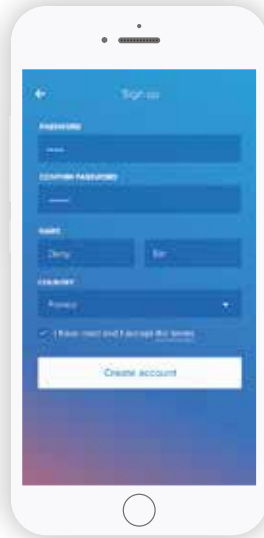

2

Create your account



3

Connect the thermostat to the home wi-fi network



4

You can start to set the programs



## SETTING THE PROGRAMS

- Select the guided procedure to set daily and weekly programs
- Set the desired temperature when at home, when away, or when sleeping
- The program is already active

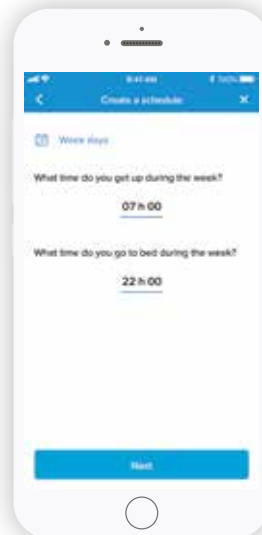

If necessary, you can call the BTicino after-sales service directly by means of the Help pushbutton integrated in the application, or by calling the free number 800-837035.



The Home + Control App is available on





## AWAY

It is possible to control the home at any time:

- Changing the temperature or the set program
- Setting the away and frost-guard functions irrespective of the set program

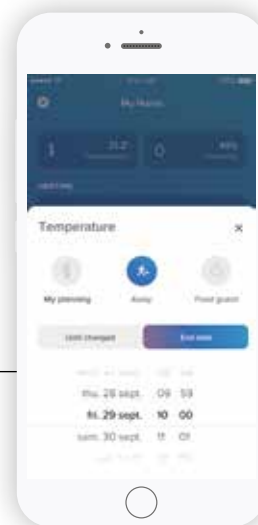

## BOOST FUNCTION

Activate the heating or cooling for a limited time, regardless of the profile set and the room temperature.

At the end of the period of operation you can be certain that the heating or cooling will switch OFF.

- Click on the “Boost” function icon.
- Select the duration (30, 60, or 90 minutes) and confirm. Heating is ON.



## MONITORING OF CONSUMPTIONS

- An easy way to have always under control your heater consumption, tracking the temperature (room and set point) and the ON time of the heater



# Maximum comfort in every zone

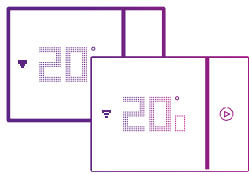

More thermostats?  
More houses?

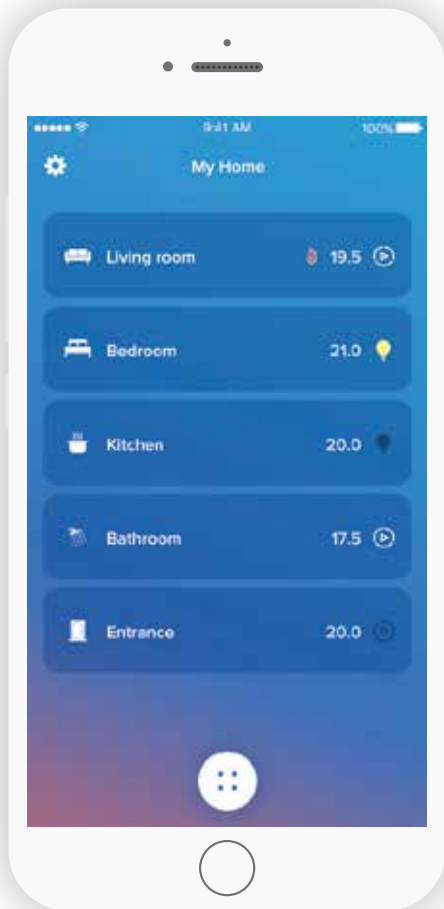

Management of several thermostats

As well as a single device you  
can also manage:

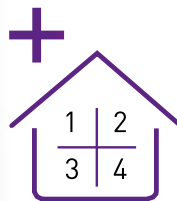

Several thermostats in the same  
home (zone isolation of the system)

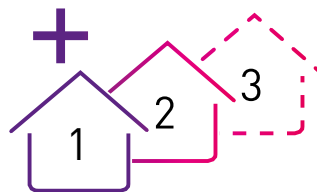

Thermostats in different buildings  
(main home and second home)

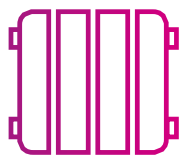

## Independent heating system with radiators?

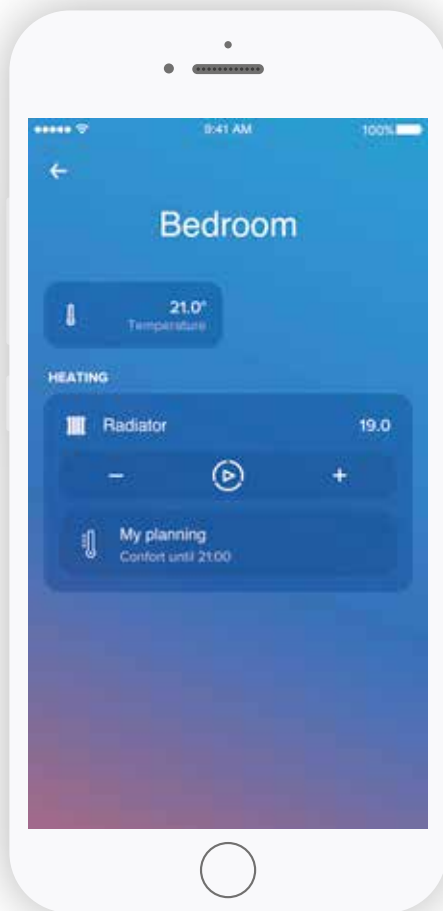

Management of the valves

Setting the temperature of every room with Smarter with Netatmo is not a problem:



Using the same Home + Control App, you can control and adjust the smart radiator valves installed on each radiator.



 Netatmo

Netatmo smart radiator valves



Home + Control

# Just one App. Several connected advantages

Using the same Home + Control App, you can control the Living Now with Netatmo or Livinglight with Netatmo connected system



**In this way, in addition to the connected thermostat, you can also manage the electric system of your home using the same App:**

- Display and check the status of lights, shutters and loads connected to sockets
- Check and monitor your consumption trends
- Activate and customise your scenarios

## Living Now WITH Netatmo

CONNECTED LIGHT POINT



## Smarter WITH Netatmo

CONNECTED THERMOSTAT



CONNECTED SHUTTER CONTROL



SOCKET WITH CONNECTED MODULE

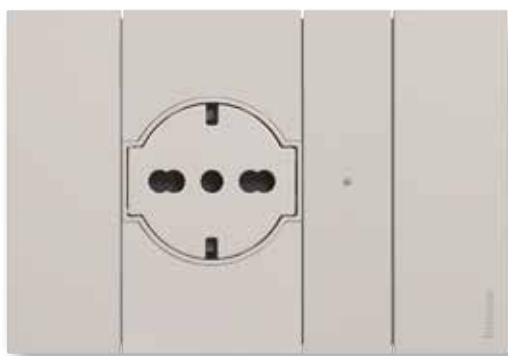

# How to install it

## Smarter with Netatmo flush mounted thermostat

Items XW8002 - XG8002 - XM8002

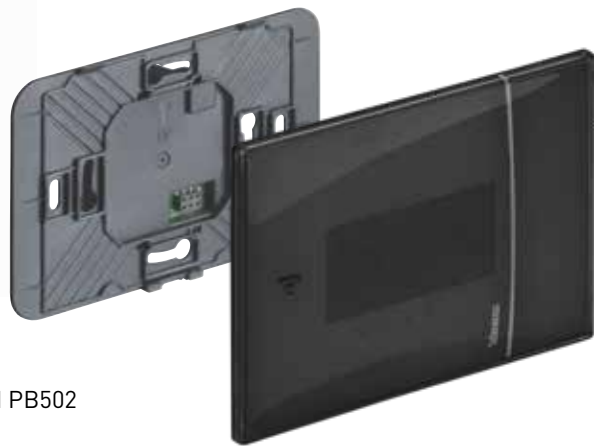

Can be installed also on:  
- flush mounted round box item 500  
(fixing using the wall dowels)  
- plasterboard boxes item PB503 and PB502

## Smarter with Netatmo wall mounted thermostat

Items XW8002W



In both types of installation  
prepare 4 cables:  
- two for the 230 V.a.c. Power supply  
- two for the boiler contact



# Easily replace the old thermostat, whether flush or wall mounted, working with batteries or supplied at 230 Va.c.

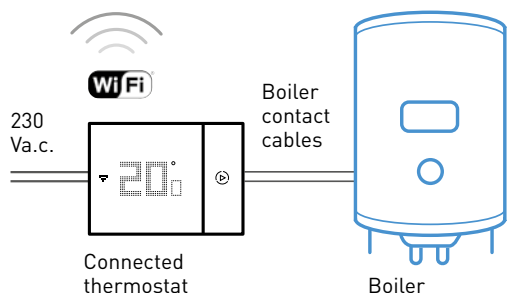

The new connected thermostat is the ideal solution for both new installations and to replace an old thermostat. Flush or wall mounted, the connected thermostat is easy to set up.

Only tip: when replacing an old battery thermostat, you will need two wires for the 230 V ac. power supply.



Wall mounted timer thermostat



Flush mounted timer thermostat



## BTicino timer thermostat replaceable with the new connected thermostat

### TABLE OF REPLACEABLE PRODUCTS

	AXOLUTE		LIVINGLIGHT		MÀTIX	
	Flush mounted	Wall mounted	Flush mounted	Wall mounted	Flush mounted	Wall mounted
Battery power supply*	<b>HD/HC/HS4451</b>		<b>N/NT/L4451</b>	<b>N/NT/L4450</b>	<b>AM5721</b>	<b>N4450</b>
	<b>HC/HS4449</b>		<b>N/L4449</b>			
230 Va.c. power supply			<b>N/NT/L4448</b>			

\* Note: for battery devices you will need the wires for the 230 Va.c. power supply

### YOU CAN ALSO REPLACE THE OLD CONNECTED THERMOSTAT WITH THE NEW SMARTER WITH NETATMO\*\*

	SMARTER X8000 - X800W 	SMARTER WITH NETATMO XW8002-XM8002 XG8002-XW8002W 
Range	<b>Flush mounted:</b> white <b>Wall mounted:</b> white	<b>Flush mounted:</b> white, black and sand <b>Wall mounted:</b> white
App	Thermostat	Home + Control
Voice Control	Google Assistant and Amazon Alexa	Google Assistant, Amazon Alexan and Apple HomeKit
Geolocation	Using the dedicated App	Using the voice assistant App
Monitoring of Consumptions	No	Yes
Management of Netatmo radiator valves	No	Yes
Energy class	Class 1	Class 4

\*\* Items X8000 and X8000W cannot be updated: to enjoy all the new functions they must be replaced with the new connected thermostats

# Smarter with Netatmo TERMOSTATO CONNESSO

## Features and connections

Front view



Rear view

### FLUSH MOUNTED VERSION

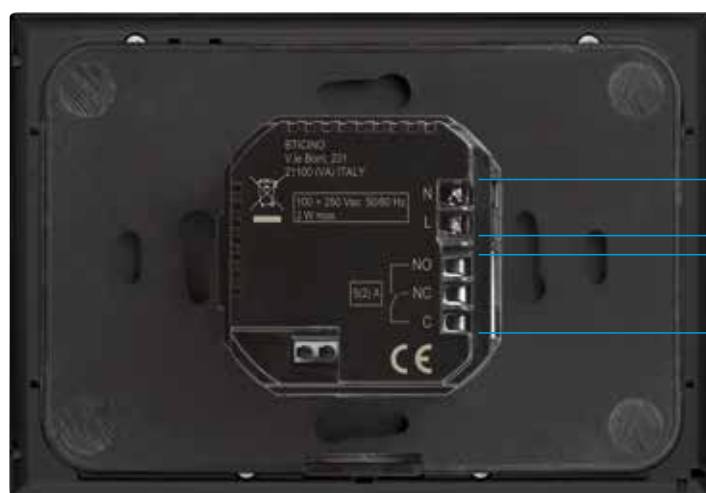

### WALL MOUNTED VERSION

Power supply 230 Va.c.

Relay contacts (connections to boilers, air conditioning, radiator valves)

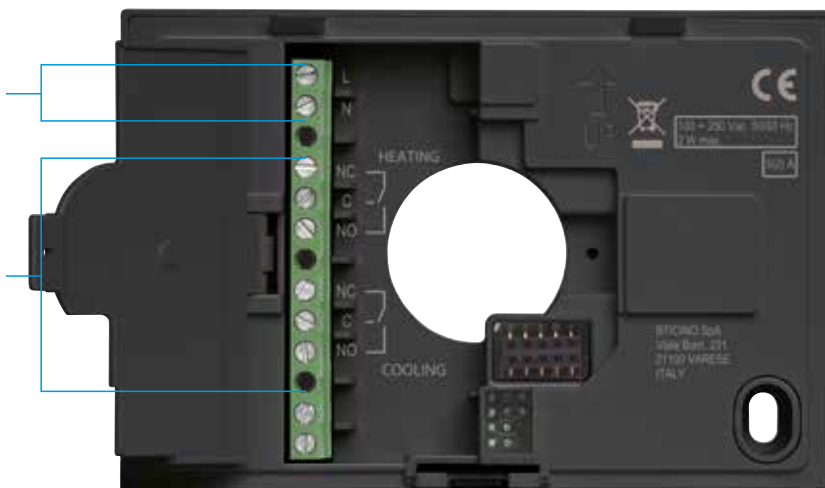



# Smarter with Netatmo CONNECTED THERMOSTAT

Catalogue



XW8002



XM8002



XG8002



XW8002W

## Item CONNECTED THERMOSTAT

- XW8002
- XM8002
- XG8002

The Smarter with Netatmo connected thermostat, together with the dedicated Thermostat APP, is a device which allows you to adjust and monitor the temperature in the rooms precisely and accurately; all the programming and most of the functions are performed simply and intuitively using the APP. Thanks to its Wi-Fi connection, Smarter can be programmed and controlled remotely; it can also display the temperature and humidity measured in the room. The temperature level can be set locally for manual operation and the Boost mode can be activated. The Boost forces the switching on of the system for a limited time (30, 60 or 90 minutes) independent of the measured and programmed temperature.

It's also possible to set a different temperature in each room of the house for the maximum comfort, thanks to its compatibility with Netatmo's intelligent radiator valves.

Smarter with Netatmo can also be controlled with Google, Amazon Alexa and Apple Home Kit voice assistants.

- Power supply 110 to 240 Vac , 50/60 Hz;
- 2 W max absorption;
- Maximum cable section 1 x 1.5 mm<sup>2</sup>;
- Operating temperature 5 to 40 °C;
- Temperature set-point 5 °C ÷ 40 °C;
- Increase of 0,5°C;
- 1-contact output in switching free of 5(2)A potential.
- Type of operation 1BU
- Pollution index 2
- Rated pulse voltage 4 kV
- Wireless device in compliance with 802.11b/g/n standard, frequency 2.4 - 2.4835 GHz, transmission power < 20 dBm. WPA/WPA2 safety protocol.

### Types of installation

- flush mounted, on boxes item 503E or 500 (for item 500 use the wall dowels)

- plasterboard, on boxes item PB503 and PB502

It is available in three colours: white (XW8002), sand (XM8002) and black (XG8002).

- XW8002W

Features: as XW8002. Installation: on the wall, using screws and dowels suitable for the installation surface (brickwork, plasterboard, tiles etc.). It is available only in white colour.

### DIMENSIONAL DATA

Flush mounted version

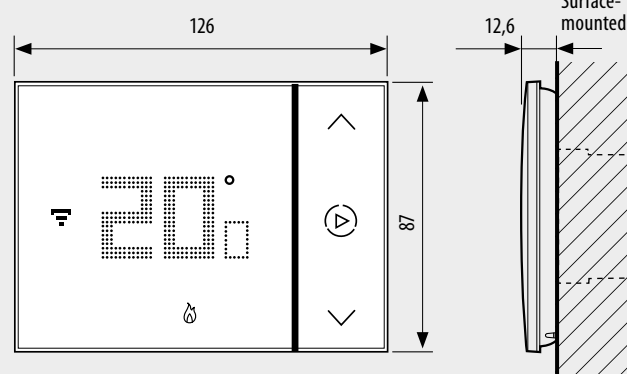

XW8002 - XM8002 - XG8002

Wall mounted version

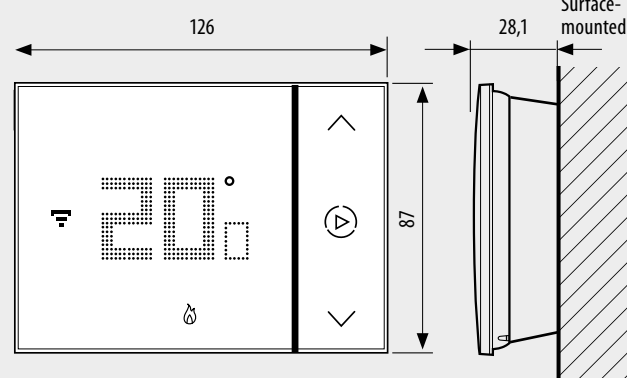

XW8002W

Size in mm



Home + Control App  
for the management of connected devices



**And if the internet does not work?**

The thermostat continues to work in the room following the set program. The App cannot be used remotely.

**BTicino** SpA  
Viale Borri, 231  
21100 Varese - Italy  
[www.bticino.com](http://www.bticino.com)

AD-EXEL/TC20C/GB - Version 03/2020

BTicino S.p.A. reserves at any time the right to modify the contents of this booklet and to communicate, in any form and modality, the changes brought to the same.