

# Dimmable LED Magnetic Track lights 48v

*magnetic 04  
track lighting*

*μαγνητικά φωτιστικά ράγας 48V & 24V*

**VK/04360TR/R/.../B**



**Product Models**

Code	Model	Box
71164-075721	VK/04360TR/R/1/B ■ Black. 48V. 1m. (L100.4cm)	1pc
71164-076721	VK/04360TR/R/1.5/B ■ Black. 48V. 1.5m. (L150.4cm)	1pc
71164-077721	VK/04360TR/R/2/B ■ Black. 48V. 2m. (L200.4cm)	1pc

**Details**

Magnetic recessed track line 48V. Length 1-2m. IP Rating IP20. Working temperature < 45°C. Material Aluminium. Must be install VK/04361 to work.

**IP20.**



4b. Measure the size of cut-out, drill the hole in the installation position

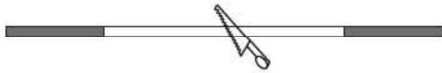

4c. Connect input end of power supply to the cable of magnetic track

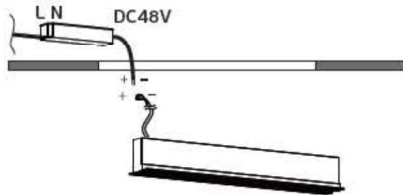

4d. Put the magnetic track into the installation hole, then fix the magnetic track by screws, and put decoration cover into the magnetic track to avoid touch dust

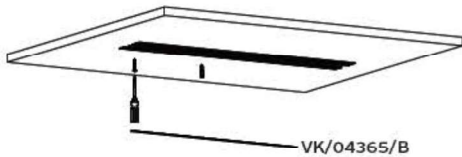

4e. After the installation of magnetic track, clean the surface

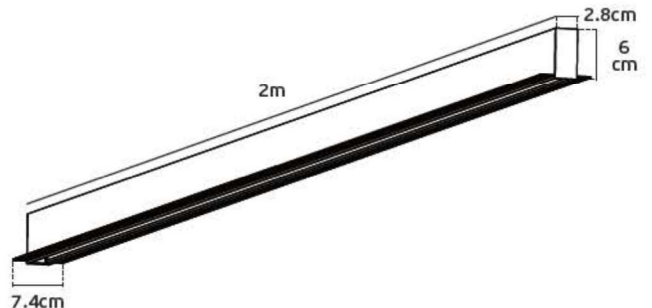
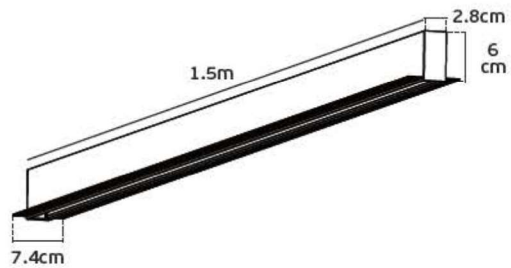
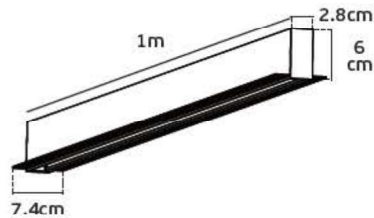
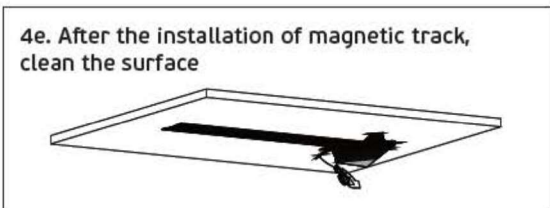

VK/04360TR/S/.../B

## Product Models

Code	Model	Box
71164-078721	VK/04360TR/S/1/B ■ Black. 48V. 1m. (L100.4cm)	1pc
71164-079721	VK/04360TR/S/1.5/B ■ Black. 48V. 1.5m. (L150.4cm)	1pc
71164-080721	VK/04360TR/S/2/B ■ Black. 48V. 2m. (L200.4cm)	1pc

## surface/pendant



## Details

Magnetic surface mounted track line 48V. Length 1-2m. IP Rating IP20.  
Working temperature < 45°C. Material Aluminium. Must be install VK/04361 to work.

IP20.

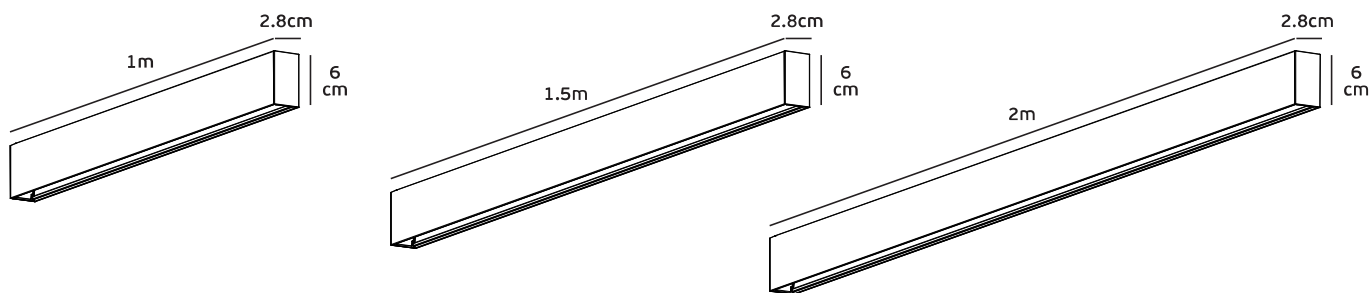

## surface

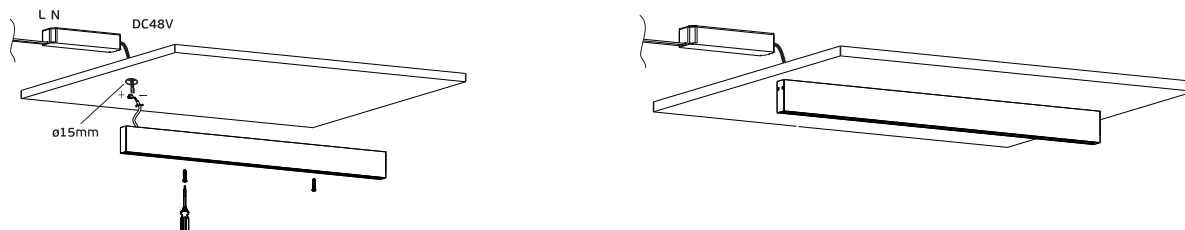

## pendant

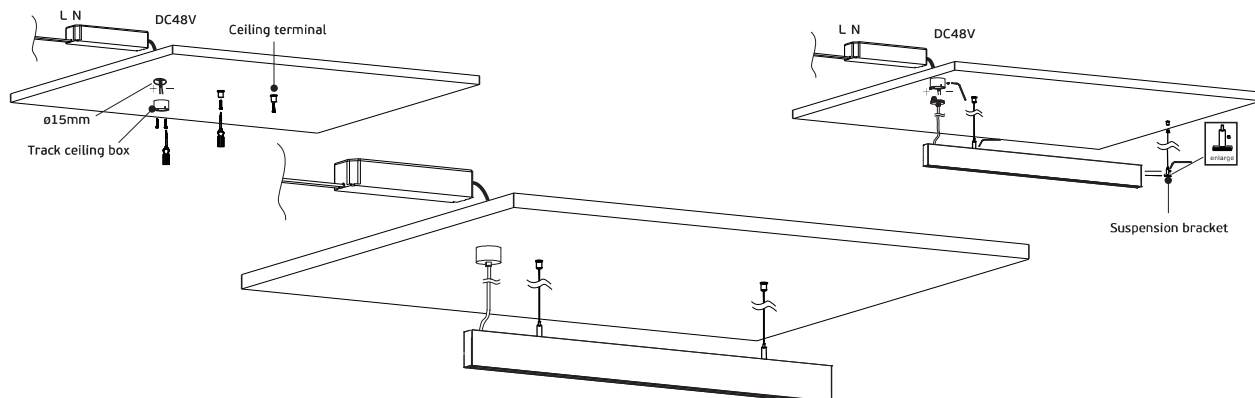

**VK/04363/RC/B/LR**



**Product Models**

Code	Model	Box
71164-086721	VK/04363/RC/B/LR ■ Black. 48V. Left & Right recessed corner	1pc

**Details**

Left/Right corner recessed.  
Track lines 48V. 2 rails link at an angle of 90°.  
Material Aluminium.  
Must be install VK/04364/PC to work (connector for corners).

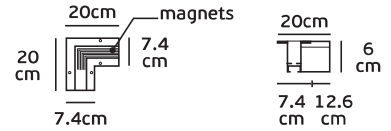

**IP20.**

**VK/04363/RC/B/IC**



**Product Models**

Code	Model	Box
71164-087721	VK/04363/RC/B/IC ■ Black. 48V. Inner corner for recessed track	1pc

**Details**

Inner corner for recessed.  
Track lines 48V. 2 rails link at an angle of 90°.  
Material Aluminium.  
Must be install VK/04364/PC to work (connector for corners).

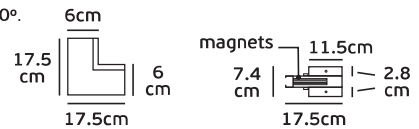

**IP20.**

**VK/04363/RC/B/OC**



**Product Models**

Code	Model	Box
71164-088721	VK/04363/RC/B/OC ■ Black. 48V. Outer corner for recessed track	1pc

**Details**

Outer corner for recessed.  
Track lines 48V. 2 rails link at an angle of 90°.  
Material Aluminium.  
Must be install VK/04364/PC to work (connector for corners).

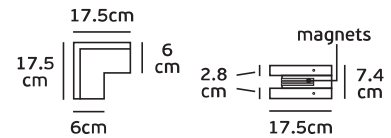

**IP20.**

**VK/04363/S/B/LR**



**Product Models**

Code	Model	Box
71164-089721	VK/04363/S/B/LR ■ Black. 48V. Left & Right corner for surface magnetic track	1pc

**Details**

Left/Right corner for surface. Track lines 48V.  
2 rails link at an angle of 90°.  
Material Aluminium.  
Must be install VK/04364/PC to work (connector for corners).

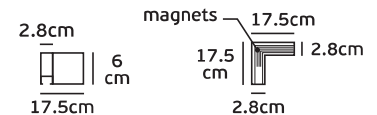

**IP20.**

**VK/04363/S/B/IC**



**Product Models**

Code	Model	Box
71164-090721	VK/04363/S/B/IC ■ Black. 48V. Inner corner for surface magnetic track	1pc

**Details**

Inner corner for surface. Track lines 48V.  
2 rails link at an angle of 90°.  
Material Aluminium.  
Must be install VK/04364/PC to work (connector for corners).



**IP20.**

**VK/04363/S/B/OC**

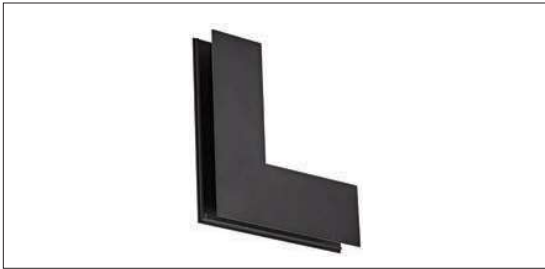

**Product Models**

Code	Model	Box
71164-091721	VK/04363/S/B/OC ■ Black. 48V. Outer corner for surface magnetic track	1pc

**Details**

Outer corner for surface. Track lines 48V.  
2 rails link at an angle of 90°.  
Material Aluminium.  
Must be install VK/04364/PC to work  
(connector for corners).

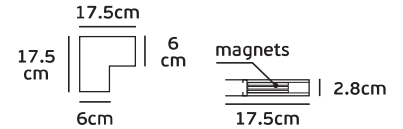

**IP20.**

**VK/04361/B**



**Product Models**

Code	Model	Box
71164-082721	VK/04361/B ■ Black. 48V.	1pc

**Details**

Power connector for recessed & surface magnetic track lines (VK/04360TR/R/... & VK/04360TR/S/...) with cable.  
Working temperature < 45°C. Material Plastic.

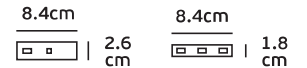

**IP20.**

**VK/04364/B/PC/2**



**Product Models**

Code	Model	Box
71164-093721	VK/04364/B/PC/2 ■ Black. 48V.	1pc

**Details**

Power connector for 2 recessed or 2 surface magnetic track 48V (VK/04360TR/R/... & VK/04360TR/S/...) with cable. Working temperature < 45°C.  
IP Rating IP20. Material Plastic.

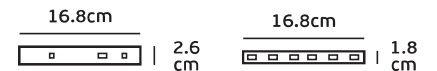

**IP20.**

**VK/04364/B/PC**

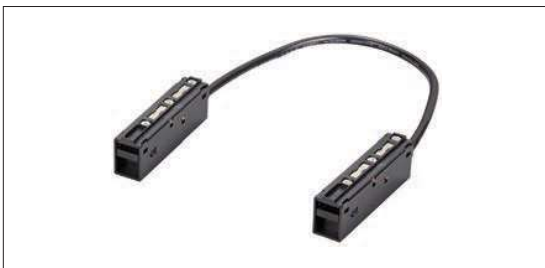

**Product Models**

Code	Model	Box
71164-092721	VK/04364/B/PC ■ Black. 48V.	1pc

**Details**

Corner Power connector for recessed & surface magnetic track 48V (VK/04360TR/R/... & VK/04360TR/S/...) with cable. Working temperature < 45°C.  
IP Rating IP20. Material Plastic.

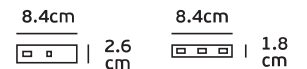

**IP20.**

**VK/04360/SRK**



**Product Models**

Code	Model	Box
71164-081721	VK/04360/SRK ■ Black. 48V.	1pc

**Details**

Hanging kit for magnetic surface track lines (VK/04360TR/S/...) 48V to become hanging track. IP Rating IP20.  
Material Aluminium.

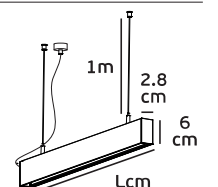

**IP20.**

■ VK/04365/B

### Product Models

Code  
71164-094721

Model  
VK/04365/B  
■ Black, 48V, 2m.

Box  
1pc

### Details

Cover for magnetic track lights 48V, decoration bar for recessed or surface tracks.  
IP Rating IP20. Working temperature < 45°C. Material PC.

IP20.

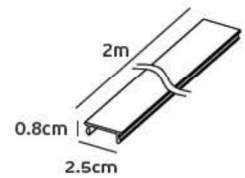

## VK/LV100W48CG



## Product Models

Code	Model	Box
71164-083721	VK/LV100W48CG 0-2100mA, 100w.	1pc

## Details

Voltage 220-240V.  $I_{in} \leq 0.6A$ .  $U_{rated} = 48V$ .  $I_{range} = 0-2100mA$ .  $P_{range} = 0-100w$ . IP Rating IP20. Working temperature  $-25^{\circ}C \rightarrow 45^{\circ}C$ . Material **Plastic housing**. 3 years guarantee.



IP20. 100w.

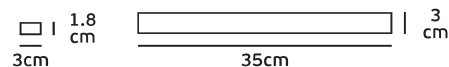

## VK/LV150W48CG



## Product Models

Code	Model	Box
71164-084721	VK/LV150W48CG 0-3125mA, 150w.	1pc

## Details

Voltage 220-240V.  $I_{in} \leq 0.9A$ .  $U_{rated} = 48V$ .  $I_{range} = 0-3125mA$ .  $P_{range} = 0-150w$ . IP Rating IP20. Working temperature  $-25^{\circ}C \rightarrow 45^{\circ}C$ . Material **Plastic housing**. 3 years guarantee.



IP20. 150w.

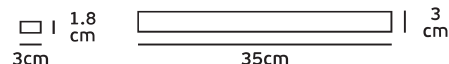

## VK/LV250W48CG



## Product Models

Code	Model	Box
71164-085721	VK/LV250W48CG 0-5210mA, 250w.	1pc

## Details

Voltage 220-240V.  $I_{in} \leq 1.5A$ .  $U_{rated} = 48V$ .  $I_{range} = 0-5210mA$ .  $P_{range} = 0-250w$ . IP Rating IP20. Working temperature  $-25^{\circ}C \rightarrow 45^{\circ}C$ . Material **Plastic housing**. 3 years guarantee.



IP20. 250w.

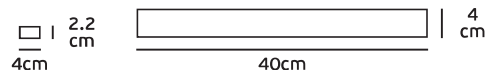



VK/04366/B/6



Product Models

Code	Model	Box
71164-095721	VK/04366/B/6 ■ Black sand. 3000K. 640lm. 9w led. 24°. CRI>90	1pc

Details

LED magnetic track light DC driver 48V (included). Watt 9w. CRI>90. IP Rating IP20  
Type of Led CREE with driver. Dimmable 1-10V. Lifetime 50.000 hrs  
Working temperature < 45°C. Material Aluminium. 2 years guarantee.

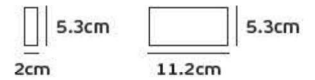
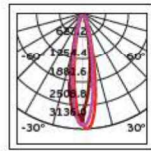

VK/04366/B/12



Product Models

Code	Model	Box
71164-096721	VK/04366/B/12 ■ Black sand. 3000K. 1.170lm. 18w led. 24°. CRI>90	1pc

Details

LED magnetic track light DC driver 48V (included). Watt 18w. CRI>90. IP Rating IP20  
Type of Led CREE with driver. Dimmable 1-10V. Lifetime 50.000 hrs  
Working temperature < 45°C. Material Aluminium. 2 years guarantee.

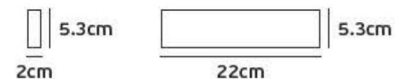
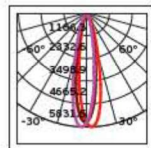

VK/04366/B/18



Product Models

Code	Model	Box
71164-097721	VK/04366/B/18 ■ Black sand. 3000K. 1.880lm. 27w led. 24°. CRI>90	1pc

Details

LED magnetic track light DC driver 48V (included). Watt 27w. CRI>90. IP Rating IP20  
Type of Led CREE with driver. Dimmable 1-10V. Lifetime 50.000 hrs  
Working temperature < 45°C. Material Aluminium. 2 years guarantee.

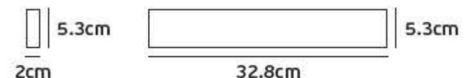
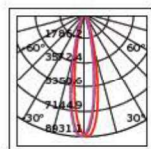

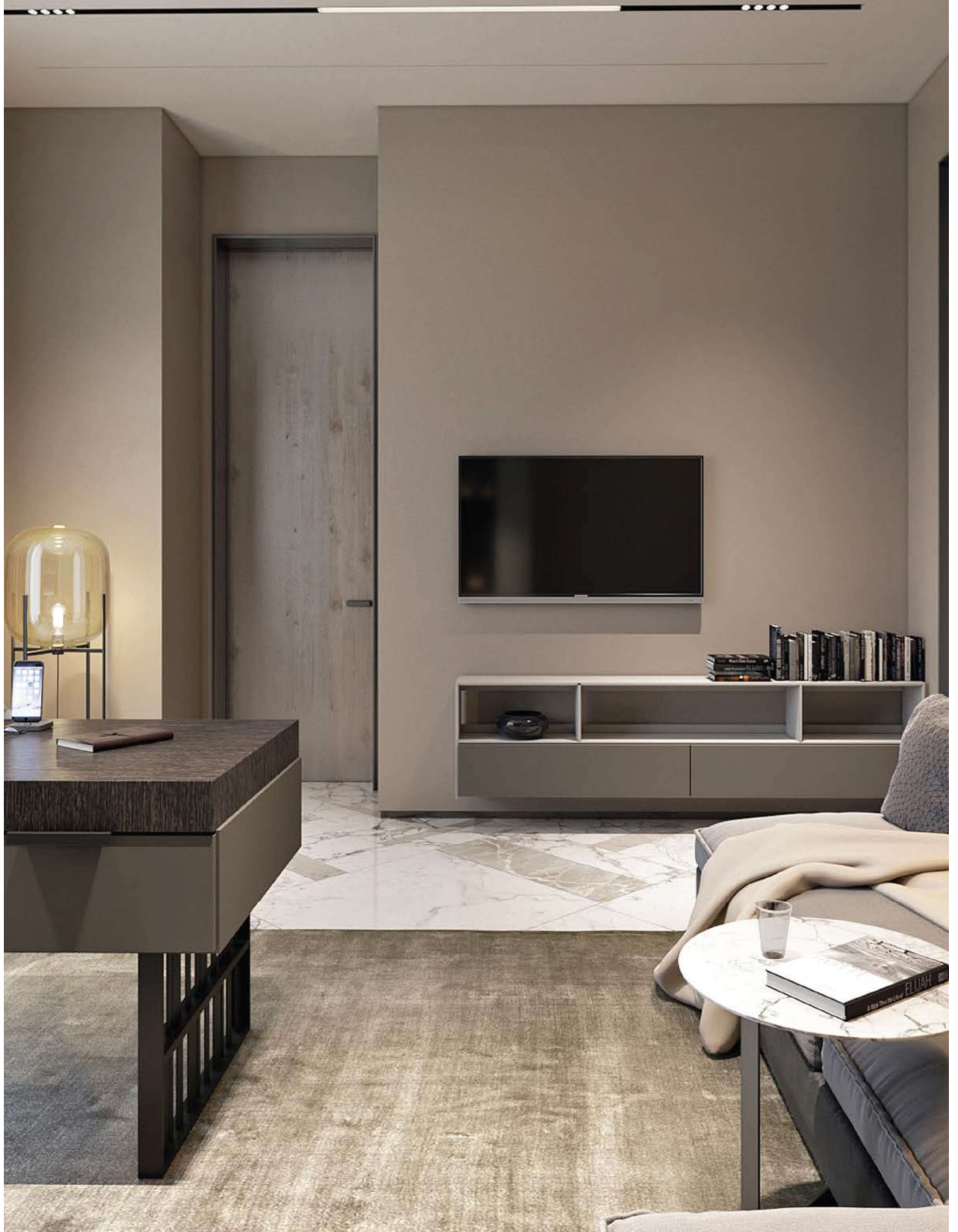

VK/04367/B/6



Product Models

Code	Model	Box
71164-098721	VK/04367/B/6 ■ Black sand. 3000K. 640lm. 9w. led. 24°. CRI>90	1pc

Details

Led magnetic track light DC driver 48V (included). Watt 9w. CRI>90. IP Rating IP20  
 Type of Led CREE with driver. Dimmable 1-10V. Lifetime 50.000 hrs  
 Working temperature < 45°C. Material Aluminium. 2 years guarantee.

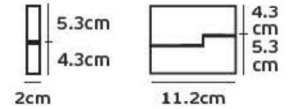
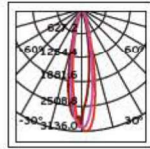

VK/04367/B/12



Product Models

Code	Model	Box
71164-099721	VK/04367/B/12 ■ Black sand. 3000K. 1.160lm. 18w. led. 24°. CRI>90	1pc

Details

Led magnetic track light DC driver 48V (included). Watt 18w. CRI>90. IP Rating IP20  
 Type of Led CREE with driver. Dimmable 1-10V. Lifetime 50.000 hrs  
 Working temperature < 45°C. Material Aluminium. 2 years guarantee.

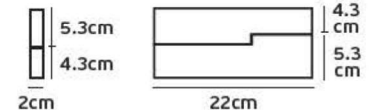
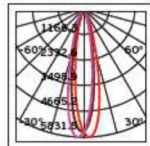

VK/04372/B



Product Models

Code	Model	Box
71164-108721	VK/04372/B ■ Black sand. 3000K. 1.420lm. 18w. bridgelux. led. 50°+<60°. CRI>90	1pc

Details

Led magnetic track light DC driver 48V (included). Watt 18w. CRI>90. IP Rating IP20  
 Type of Led bridgelux 5050 with driver. Dimmable 1-10V. Lifetime 50.000 hrs  
 Working temperature < 45°C. Material Aluminium. 2 years guarantee.

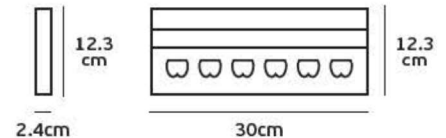
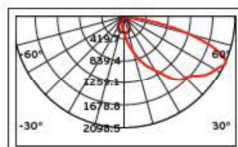

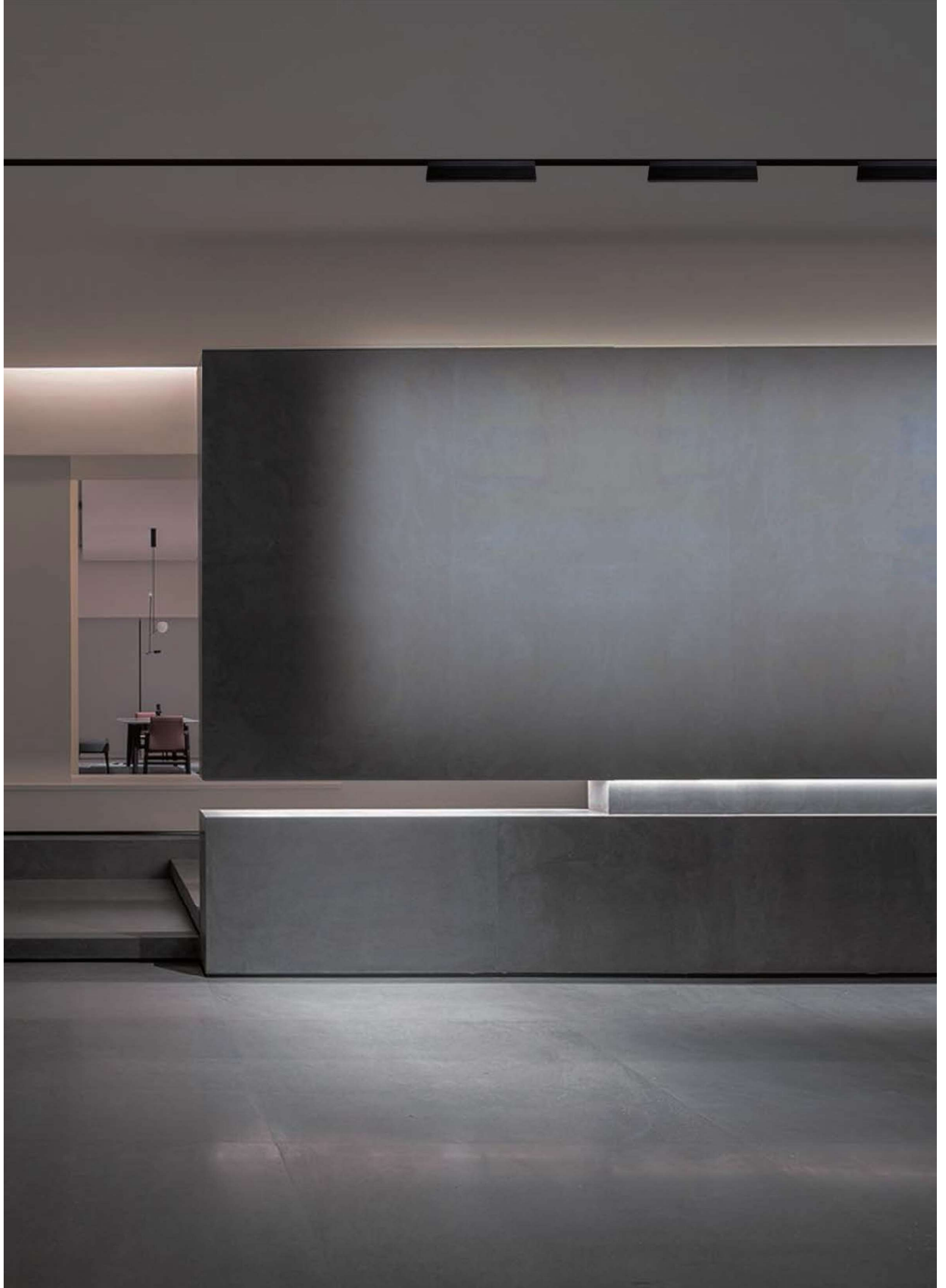

VK/04368/B/9



Product Models

Code	Model	Box
71164-100721	VK/04368/B/9 ■ Black sand. 3000K. 490lm. 9w. <i>bridgelux</i> . led. 110°. CRI>90	1pc

Details

Led magnetic track light DC driver 48V (included). Watt 9w. CRI>90. IP Rating IP20  
 Type of Led *bridgelux*. 2835 with driver. Dimmable 1-10V. Lifetime 50.000 hrs  
 Working temperature < 45°C. Material Aluminium. 2 years guarantee.

IP20. 9w.

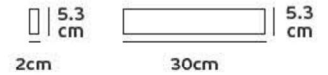
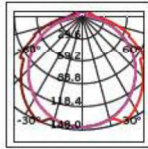

VK/04368/B/15



Product Models

Code	Model	Box
71164-101721	VK/04368/B/15 ■ Black sand. 3000K. 720lm. 15w. <i>bridgelux</i> . led. 110°. CRI>90	1pc

Details

Led magnetic track light DC driver 48V (included). Watt 15w. CRI>90. IP Rating IP20  
 Type of Led *bridgelux*. 2835 with driver. Dimmable 1-10V. Lifetime 50.000 hrs  
 Working temperature < 45°C. Material Aluminium. 2 years guarantee.

IP20. 15w.

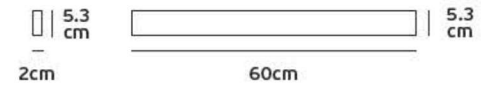
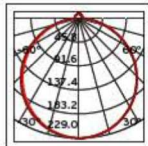

VK/04368/B/25



Product Models

Code	Model	Box
71164-102721	VK/04368/B/25 ■ Black sand. 3000K. 1.020lm. 25w. <i>bridgelux</i> . led. 110°. CRI>90	1pc

Details

Led magnetic track light DC driver 48V (included). Watt 25w. CRI>90. IP Rating IP20  
 Type of Led *bridgelux*. 2835 with driver. Dimmable 1-10V. Lifetime 50.000 hrs  
 Working temperature < 45°C. Material Aluminium. 2 years guarantee.

IP20. 25w.

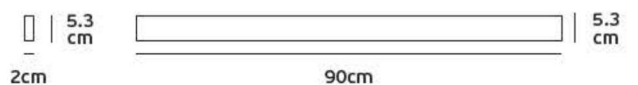
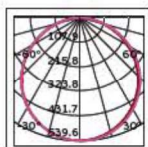

VK/04369/B

## Product Models

## Code

71164-103721

## Model

VK/04369/B

## Box

1pc

■ Black sand. 3000K. 535lm. 9w.  led. 110°. CRI>90

## Details

Led magnetic track light DC driver 48V (included). Watt 9w. CRI&gt;90. IP Rating IP20

Type of Led  2835 with driver. Dimmable 1-10V. Lifetime 50.000 hrs

Working temperature &lt; 45°C. Material Aluminium. 2 years guarantee.



IP20. 9w.

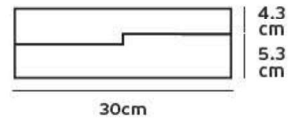
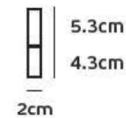
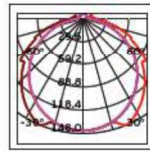



VK/04370/B/13

Product Models

<b>Code</b> 71164-104721	<b>Model</b> VK/04370/B/13	■ Black sand	3000K	1.250lm	13w.	bridgelux.	110°	CRI>90	<b>Box</b> 1pc
-----------------------------	-------------------------------	--------------	-------	---------	------	------------	------	--------	-------------------

Details

Led magnetic track light DC driver 48V (included). Watt 13w. CRI>90. IP Rating IP20. Type of Led *bridgelux.* 2835 with driver. Dimmable 1-10V. Lifetime 50.000 hrs Working temperature < 45°C. Material Aluminium. 2 years guarantee.



**IP20. 13w.**

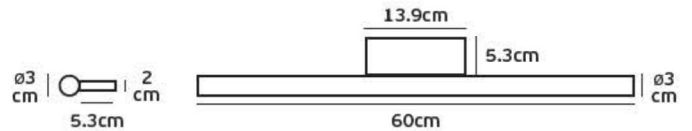
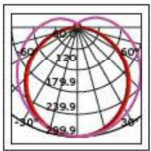

VK/04370/B/20

Product Models

<b>Code</b> 71164-105721	<b>Model</b> VK/04370/B/20	■ Black sand.	3000K.	1.840lm.	20w.	bridgelux.	110°.	CRI>90	<b>Box</b> 1pc
-----------------------------	-------------------------------	---------------	--------	----------	------	------------	-------	--------	-------------------

Details

Led magnetic track light DC driver 48V (included). Watt 20w. CRI>90. IP Rating IP20 Type of Led *bridgelux.* 2835 with driver. Dimmable 1-10V. Lifetime 50.000 hrs Working temperature < 45°C. Material Aluminium. 2 years guarantee.



**IP20. 20w.**

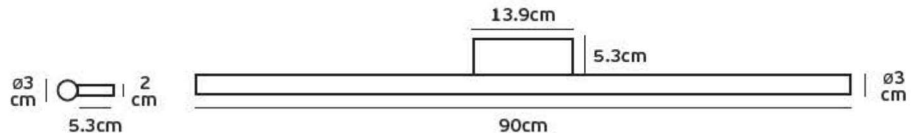
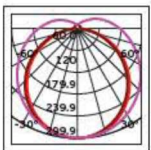





# LED Magnetic Track lights 48V



VK/04371/B/20

## Product Models

Code	Model	Color	Temp	Length	Power	Brand	Beam	CR	Box
71164-106721	VK/04371/B/20	Black sand.	3000K.	1.840lm.	20w.	bridgelux.	110°.	CRI>90	1pc

### Details

Led magnetic track light DC driver 48V (included). Watt 20w. CRI>90. IP Rating IP20 Type of Led [bridgelux](#). 2835 with driver. Dimmable 1-10V. Lifetime 50.000 hrs Working temperature < 45°C. Material Aluminium. 2 years guarantee.



IP20. 20w.

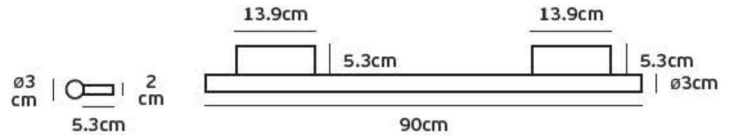
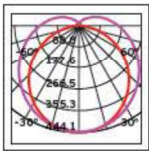

VK/04371/B/28

## Product Models

Code	Model	Color	Temp	Length	Power	Brand	Beam	CR	Box
71164-107721	VK/04371/B/28	Black sand.	3000K.	2.430lm.	28w.	bridgelux.	110°.	CRI>90	1pc

### Details

Led magnetic track light DC driver 48V (included). Watt 28w. CRI>90. IP Rating IP20 Type of Led [bridgelux](#). 2835 with driver. Dimmable 1-10V. Lifetime 50.000 hrs Working temperature < 45°C. Material Aluminium. 2 years guarantee.



IP20. 28w.

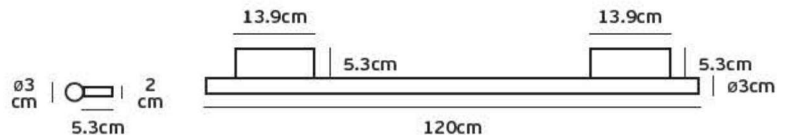
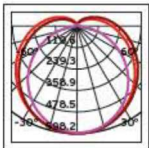

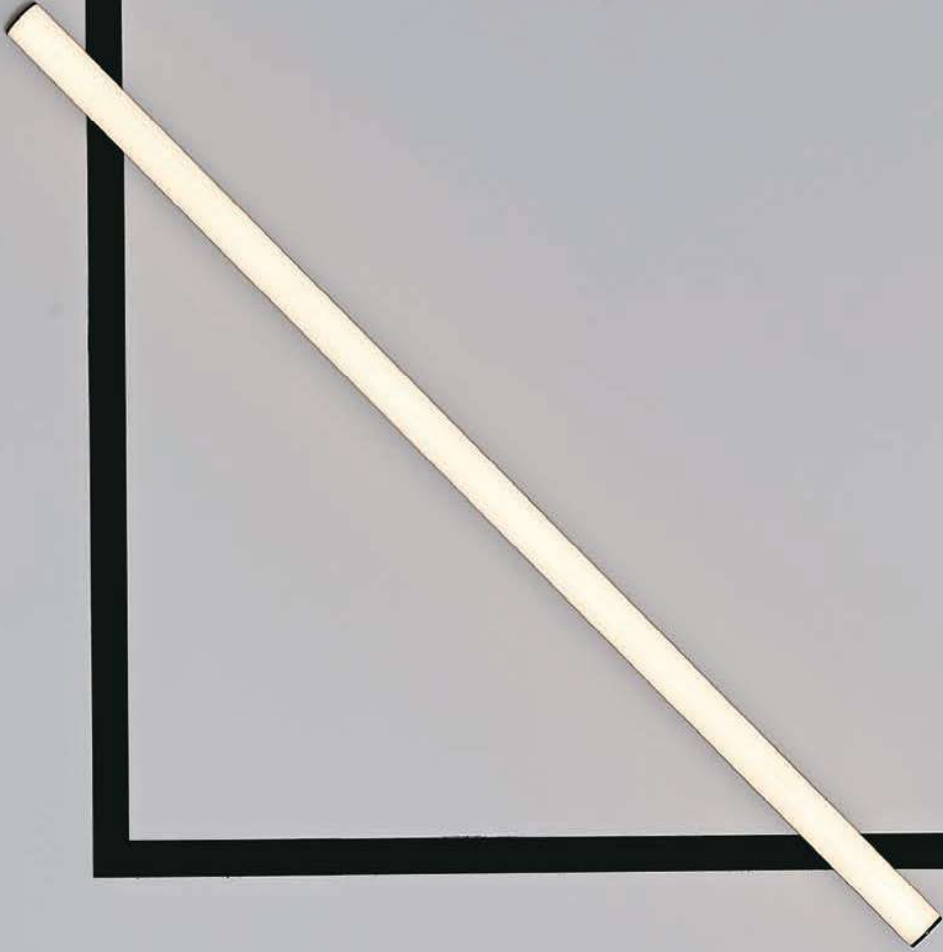

VK/04373/B



Product Models

Code	Model	Box
71164-109721	VK/04373/B	1pc
■ Black sand. 3000K. 220lm. 3w.  led. 8°. CRI>90		

Details

Led magnetic track light DC driver 48V (included). Watt 3w. CRI>90. IP Rating IP20  
 Type of Led  with driver. Dimmable 1-10V. Lifetime 50.000 hrs  
 Working temperature < 45°C. Material Aluminium. 2 years guarantee.

   IP20. 3w.

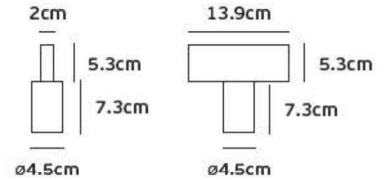
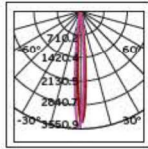

VK/04374/B



Product Models

Code	Model	Box
71164-110721	VK/04374/B	1pc
■ Black sand. 3000K. 590lm. 9w. 8°. CRI>90		

Details

Led magnetic track light DC driver 48V (included). Watt 9w. CRI>90. IP Rating IP20  
 Type of Led CREE XHP-35 with driver. Dimmable 1-10V. Lifetime 50.000 hrs  
 Working temperature < 45°C. Material Aluminium. 2 years guarantee.

   IP20. 9w.

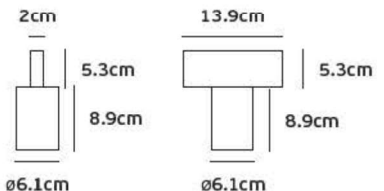
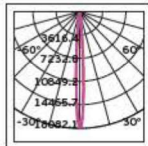

VK/04375/B



Product Models

Code	Model	Box
71164-111721	VK/04375/B	1pc
■ Black sand. 3000K. 530lm. 7w.  led. 24°. CRI>90		

Details

Led magnetic track light DC driver 48V (included). Watt 7w. CRI>90. IP Rating IP20  
 Type of Led  E6 with driver. Dimmable 1-10V. Lifetime 50.000 hrs  
 Working temperature < 45°C. Material Aluminium. 2 years guarantee.

   IP20. 7w.

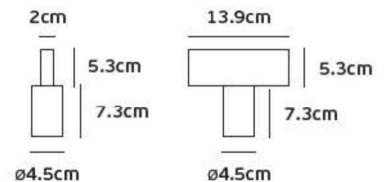
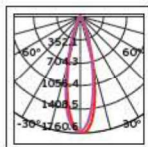

VK/04376/B/12

## Product Models

Code

71164-112721

Model

VK/04376/B/12

Box

1pc

■ Black sand. 3000K. 880lm. 12w. *bridgelux*. led. 24°. CRI>90*Details*

Led magnetic track light DC driver 48V (included). Watt 12w. CRI&gt;90. IP Rating IP20

Type of Led *bridgelux*. E8 with driver. Dimmable 1-10V. Lifetime 50.000 hrs

Working temperature &lt; 45°C. Material Aluminium. 2 years guarantee.



IP20. 12w.

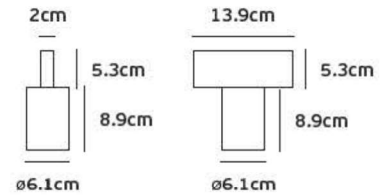
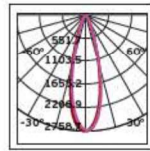

**VK/04376/B/HC/15**  
With honeycomb cover



**Product Models**

Code	Model	Box
71164-113721	VK/04376/B/HC/15 ■ Black sand. 3000K. 650lm. 15w. <i>bridgelux</i> . led. 24°. CRI>90	1pc

**Details**

Led magnetic track light with honeycomb cover DC driver 48V (included). Watt 15w. CRI>90. IP Rating IP20. Type of Led *bridgelux*. with driver. Dimmable 1-10V. Lifetime 50.000 hrs. Working temperature < 45°C. Material Aluminium. 2 years guarantee.



**IP20. 15w.**

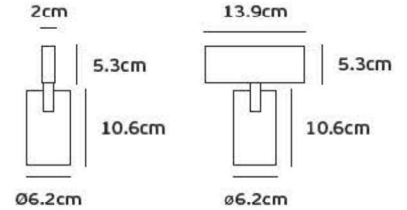
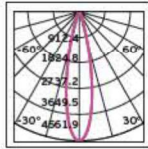

**VK/04377/B/HC/18**  
With honeycomb cover



**Product Models**

Code	Model	Box
71164-114721	VK/04377/B/HC/18 ■ Black sand. 3000K. 1.340lm. 18w. <i>bridgelux</i> . led. 24°. CRI>90	1pc

**Details**

Led magnetic track light with honeycomb cover DC driver 48V (included). Watt 18w. CRI>90. IP Rating IP20. Type of Led *bridgelux*. with driver. Dimmable 1-10V. Lifetime 50.000 hrs Working temperature < 45°C. Material Aluminium. 2 years guarantee.



**IP20. 18w.**

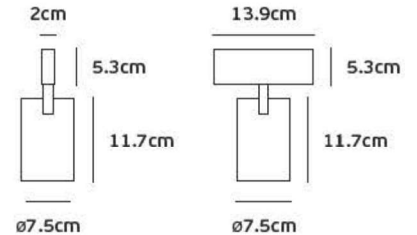
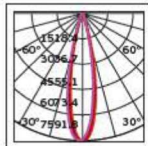

**VK/04377/B/HC/25**  
With honeycomb cover



**Product Models**

Code	Model	Box
71164-115721	VK/04377/B/HC/25 ■ Black sand. 3000K. 1.660lm. 25w. <i>bridgelux</i> . led. 24°. CRI>90	1pc

**Details**

Led magnetic track light with honeycomb cover DC driver 48V (included). Watt 25w. CRI>90. IP Rating IP20. Type of Led *bridgelux*. with driver. Dimmable 1-10V. Lifetime 50.000 hrs. Working temperature < 45°C. Material Aluminium. 2 years guarantee.



**IP20. 25w.**

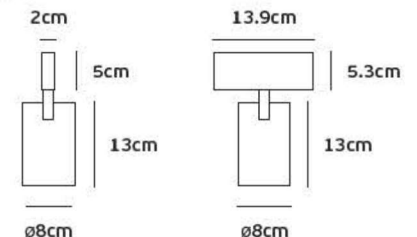
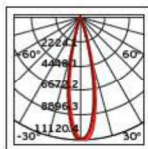

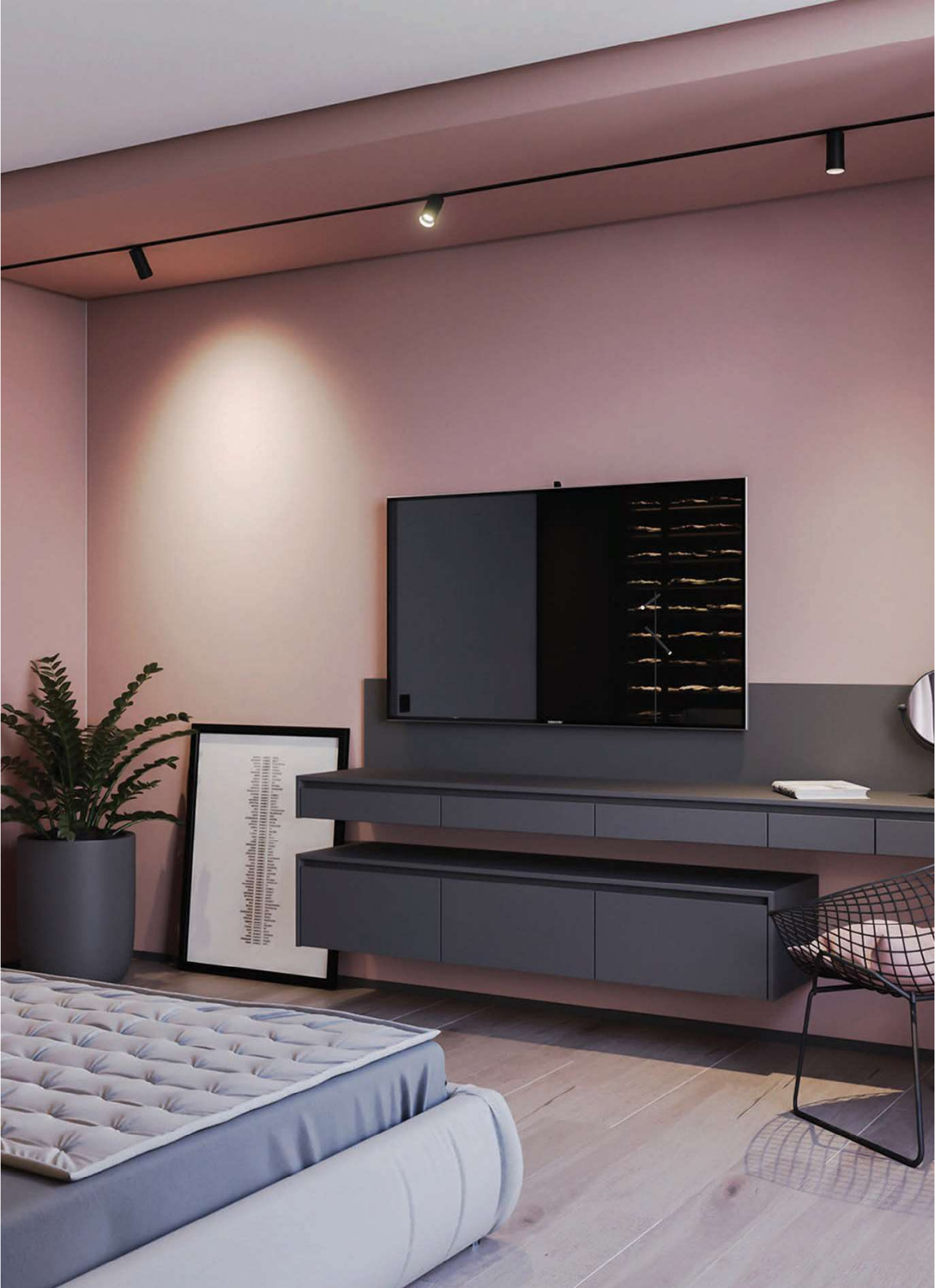

**VK/04378/B/ZM**  
Zoom light 15°-45°



**Product Models**

Code	Model	Box
71164-116721	VK/04378/B/ZM	1pc
■ Black sand. 3000K. 440lm. 7w. <i>bridgelux</i> . led. Zoom 15°-45°. CRI>90		

**Details**

Led magnetic track Zoom Light DC driver 48V (included). Watt 7w. CRI>90  
IP Rating IP20. Type of Led *bridgelux*. with driver. Dimmable 1-10V. Lifetime 50.000 hrs  
Working temperature < 45°C. Material Aluminium. 2 years guarantee.

**IP20. 7w.**

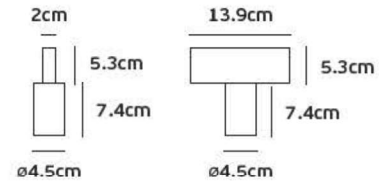
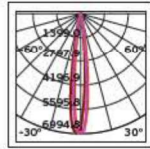

**VK/04379/B/ZM**  
Zoom light 15°-60°



**Product Models**

Code	Model	Box
71164-117721	VK/04379/B/ZM	1pc
■ Black sand. 3000K. 780lm. 12w. <i>bridgelux</i> . led. Zoom 15°-60°. CRI>90		

**Details**

Led magnetic track Zoom Light DC driver 48V (included). Watt 12w. CRI>90.  
IP Rating IP20. Type of Led *bridgelux*. V6 HD with driver. Dimmable 1-10V. Lifetime 50.000hrs.  
Working temperature < 45°C. Material Aluminium. 2 years guarantee.

**IP20. 12w.**

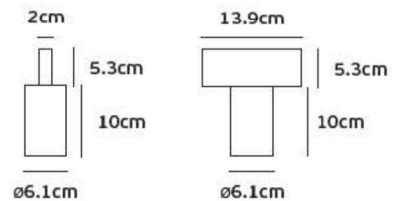
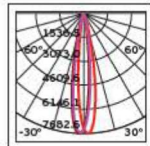

**VK/04380/B/ZM**  
Zoom light 15°-60°



**Product Models**

Code	Model	Box
71164-118721	VK/04380/B/ZM	1pc
■ Black sand. 3000K. 1.540lm. 18w. <i>bridgelux</i> . led. Zoom 15°-60°. CRI>90		

**Details**

Led magnetic track Zoom Light DC driver 48V (included). Watt 18w. CRI>90.  
IP Rating IP20. Type of Led *bridgelux*. V10C with driver. Dimmable 1-10V. Lifetime 50.000hrs.  
Working temperature < 45°C. Material Aluminium. 2 years guarantee.

**IP20. 18w.**

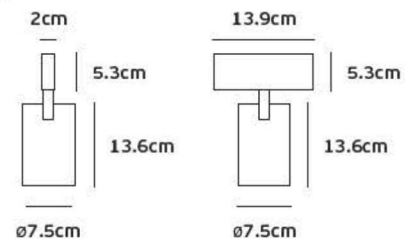
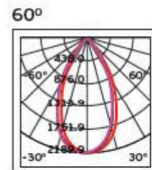
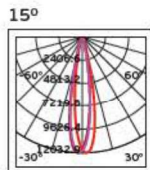

**VK/04381/B/ZM**  
Zoom light 15°-60°



### Product Models

**Code**

71164-119721

**Model**

VK/04381/B/ZM

**Box**

1pc

■ Black sand. 3000K. 1.870lm. 25w. [bridgelux](#). led. Zoom 15°-60°. CRI>90

### Details

Led magnetic track Zoom Light DC driver 48V (included). Watt 25w. CRI>90.

IP Rating IP20. Type of Led [bridgelux](#). V9 HD with driver. Dimmable 1-10V. Lifetime 50.000hrs.

Working temperature < 45°C. Material Aluminium. 2 years guarantee.



IP20. 25w.

15°

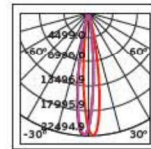

60°

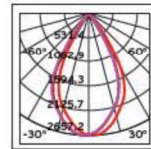

2cm



5.3cm



14.7cm



ø8cm

13.9cm

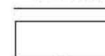

5.3cm

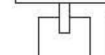

14.7cm



ø8cm





VK/04382/CE/B

### Product Models

**Code**  
71164-120721

**Model**  
VK/04382/CE/B  
■ Black sand. 3000K. 350lm. 6w. *bridgelux*. led. 24°. CRI>90

**Box**  
1pc



### Details

Led magnetic track Pendant Light DC driver 48V (included). Watt 6w. CRI>90. IP Rating IP20. Type of Led *bridgelux*. E6 CA with driver. Dimmable 1-10V. Lifetime 50.000hrs. Working temperature < 45°C. Material Aluminium. 2 years guarantee.



IP20. 6w.

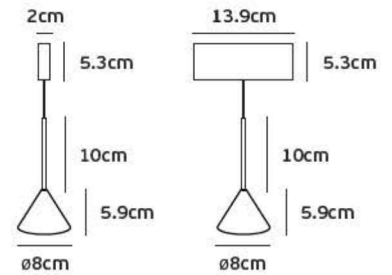

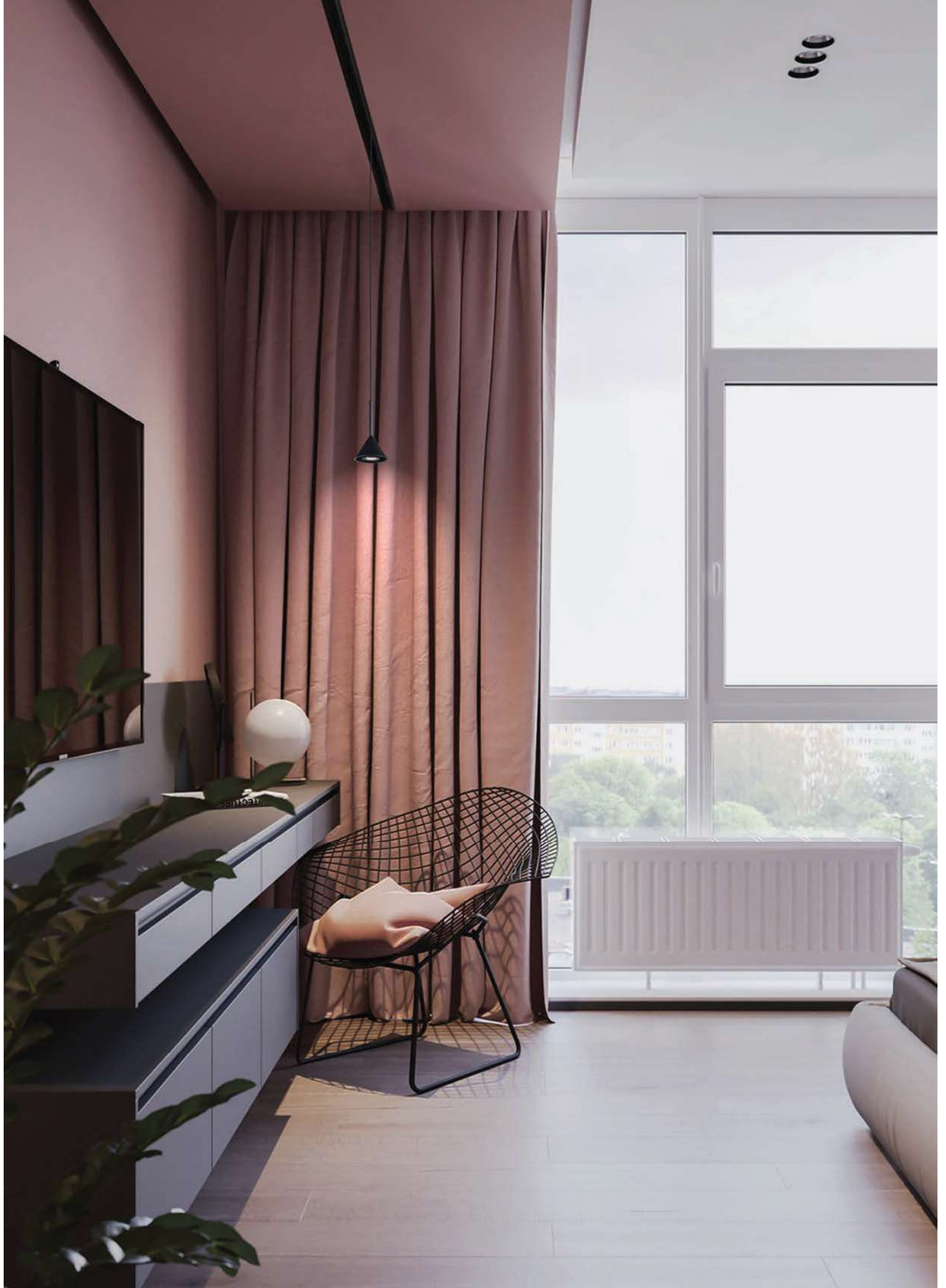

**Συνδεσμολογία Μαγνητικής Ράγας 48V**  
**1. Magnet Track System Electrical Diagram 48V**

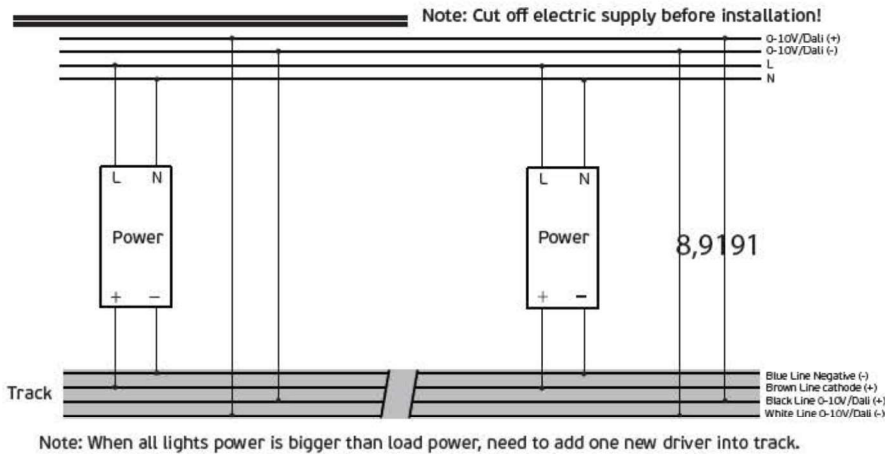

**Διάγραμμα κοπής για το τροφοδοτικό**  
**2. The cut out diagram of the driver**

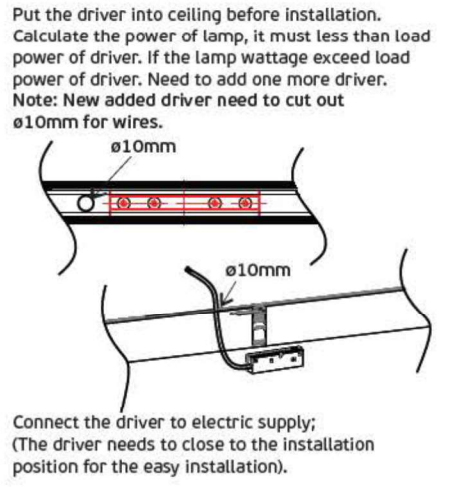

Cut off electric supply before installation!

**Διάγραμμα σύνδεσης track φωτιστικών 48V** **3. Track connection diagram 48V**

**3a. Power head connection diagram/Διάγραμμα σύνδεσης παροχής ενέργειας**

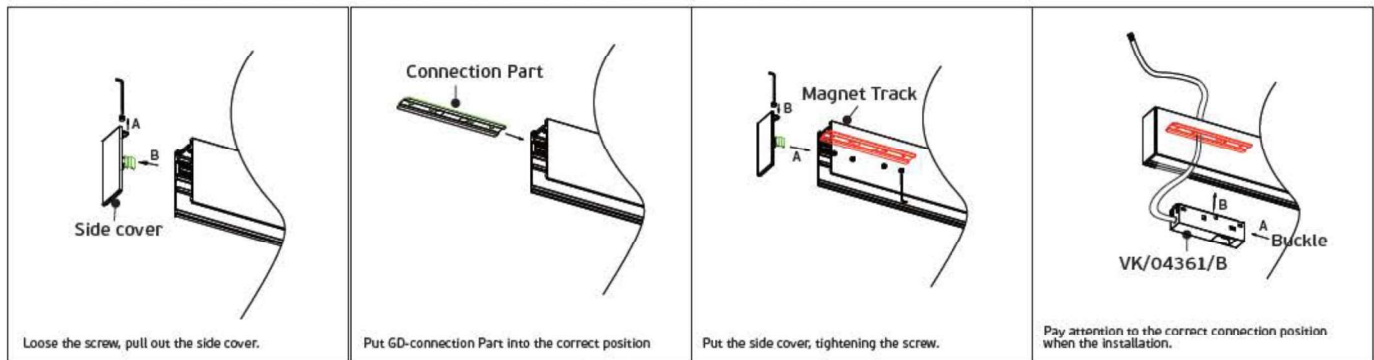

**3b. The corner connection diagram/Διάγραμμα γωνιακής σύνδεσης**

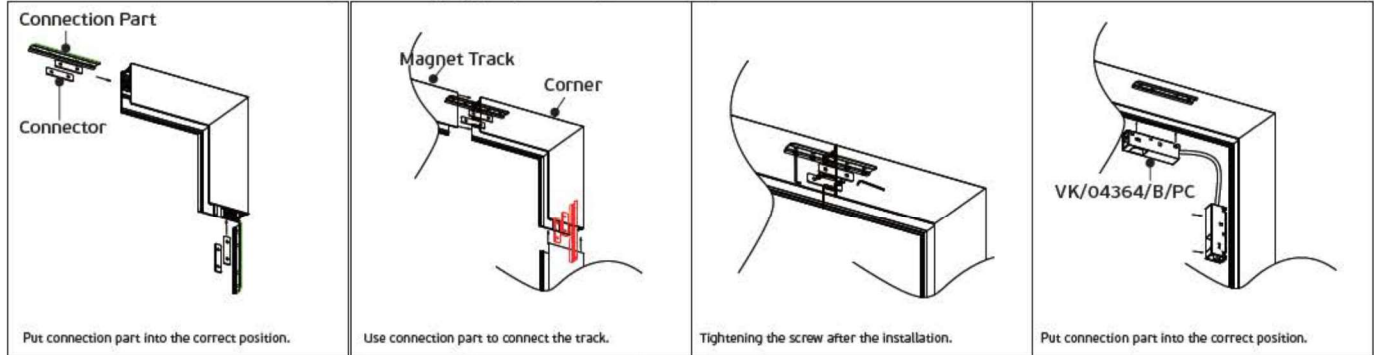

**3c. Track connection diagram/Διάγραμμα σύνδεσης σε σειρά**

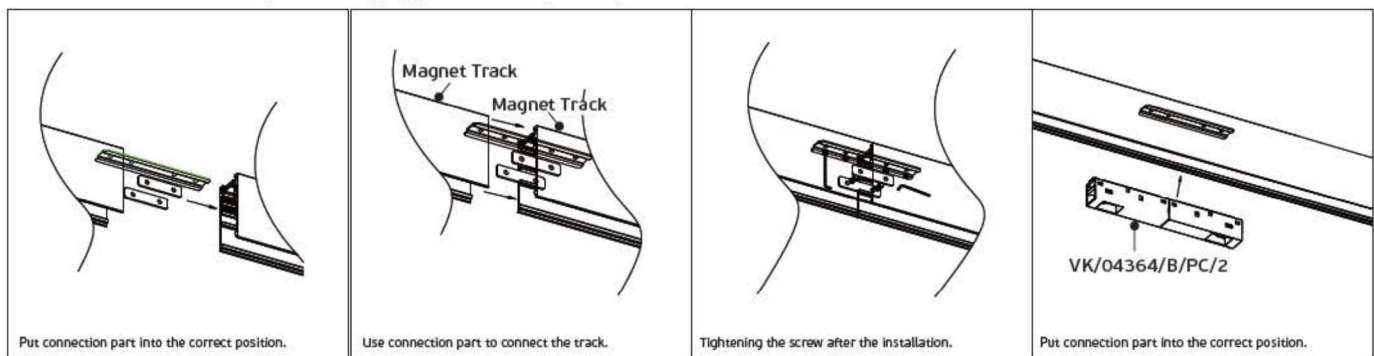

Οδηγίες εγκατάστασης χωνευτής μαγνητικής ράγας 48V

4. Recessed magnetic track installation diagram 48V

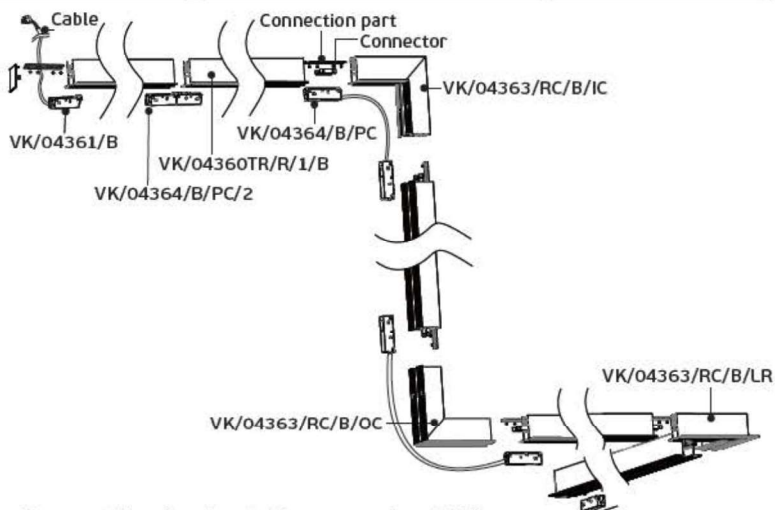

4a. Recessed track cut-out size comparison table  
Συγκριτικός Πίνακας διαστάσεων κοπής

Product drawing	Models	Cut-out	Cut-out size
	VK/04360TR/R/1/B VK/04360TR/R/1.5/B VK/04360TR/R/2/B	L1005xW30mm L1505xW30mm L2005xW30mm	
	VK/04363/RC/B/IC	L120xW30mm	
	VK/04363/RC/B/OC	L170xW30mm	
	VK/04363/RC/B/LR	L180xW30mm	

4b. Measure the size of cut-out, drill the hole in the installation position

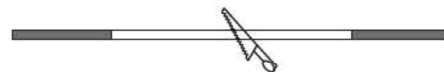

4c. Connect input end of power supply to the cable of magnetic track

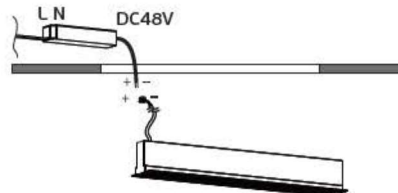

4d. Put the magnetic track into the installation hole, then fix the magnetic track by screws, and put decoration cover into the magnetic track to avoid touch dust

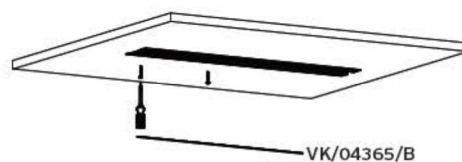

4e. After the installation of magnetic track, clean the surface



Οδηγίες εγκατάστασης επιτοίχιας μαγνητικής ράγας 48V

5. Surface-mounted magnetic track installation diagram 48V

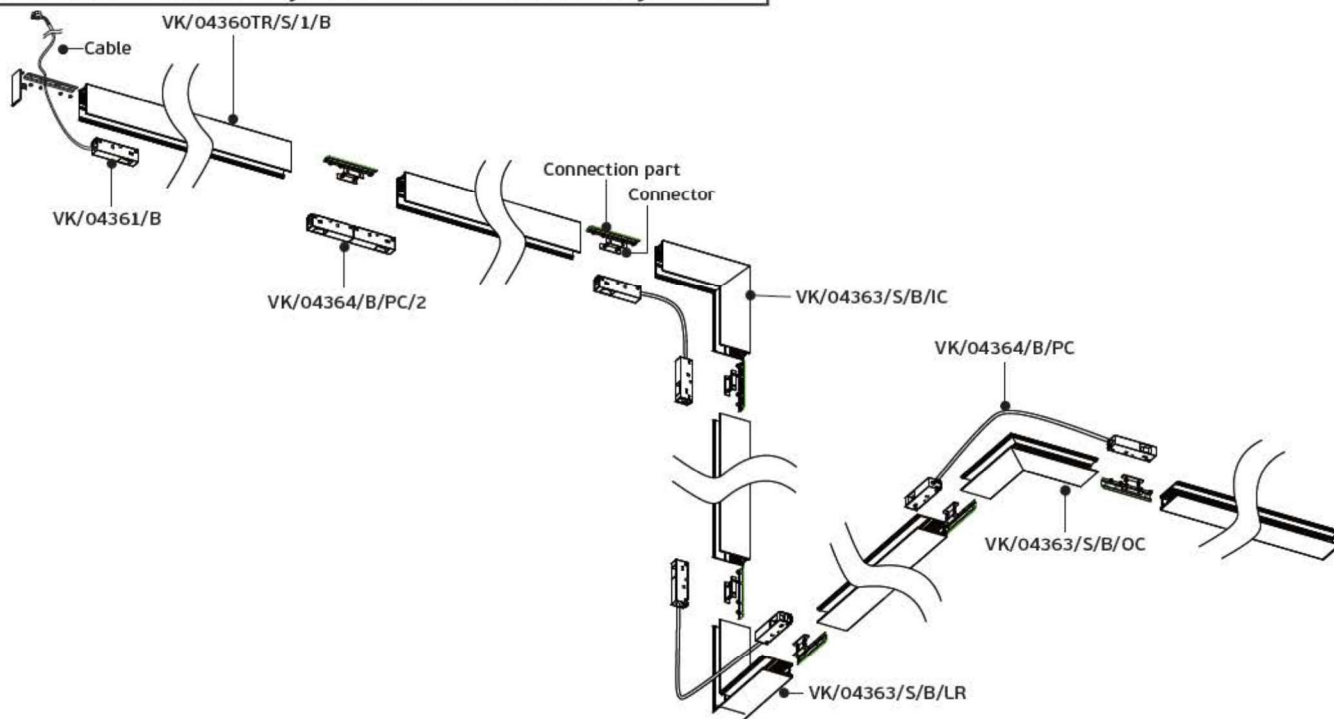

5a. Connect input end of power supply to the cable of magnetic track, then fix surface-mounted magnetic track by screws

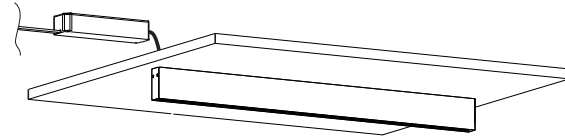
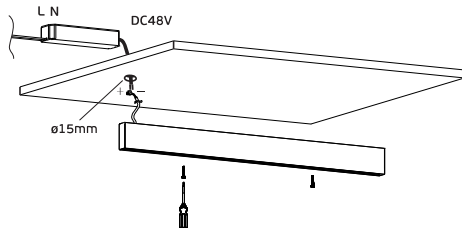

**Οδηγίες εγκατάστασης κρεμαστής μαγνητικής ράγας 48V**

**6. Hanging magnetic track installation diagram 48V**

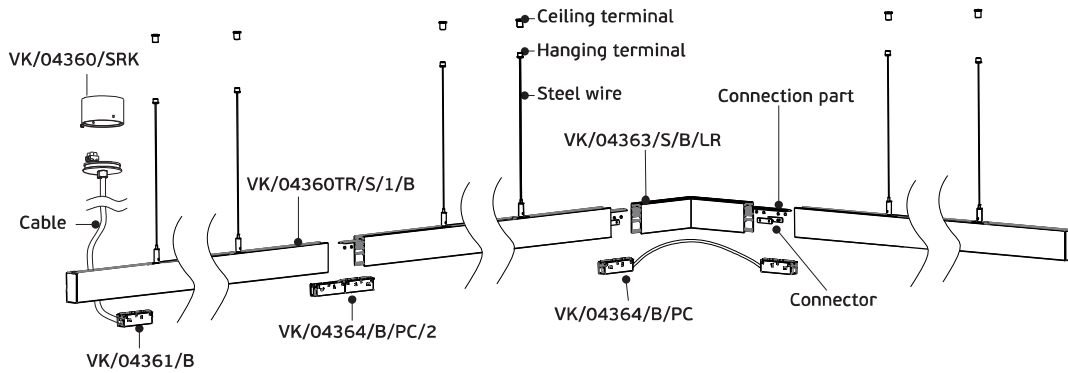

6a. Fix the ceiling box and ceiling terminal by screws first

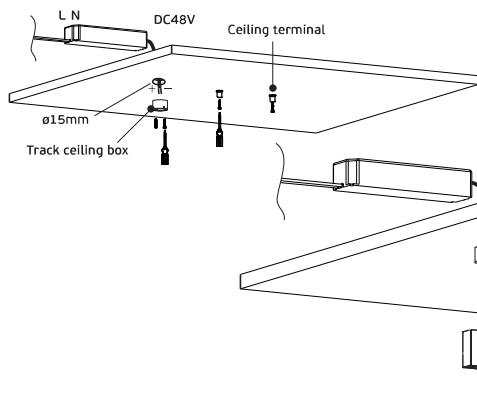

6b. Connect output of power supply to the cable of magnetic track (Install hanging fixture first, then tightening the screws)

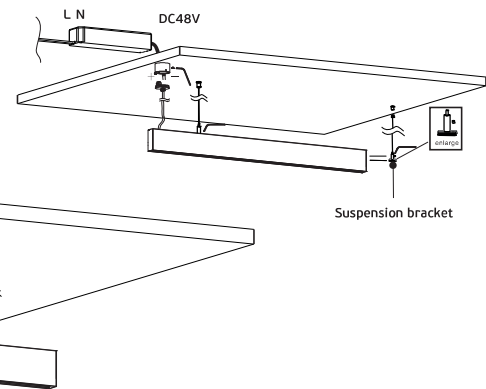

**Σύνδεση 0-10V Dim Dali μαγνητικής ράγας 48V**

**7. 0-10V Dimming/Dali Dimming connection diagram 48V**

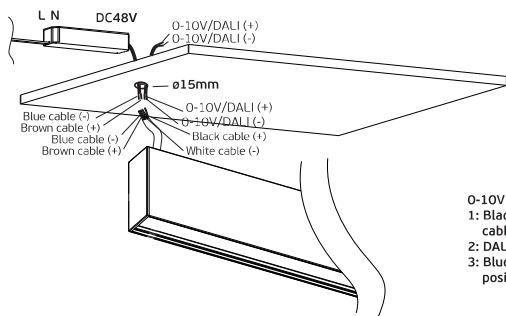

- 0-10V Dimming/DALI Dimming:
- 1: Black cable connect dimming positive pole/white cable connect dimming negative pole.
  - 2: DALI module connect black cable.
  - 3: Blue/Brown cable connect power supply, output positive pole and negative.

**Εγκατάσταση φωτιστικών στη μαγνητική ράγα 48V**

**8. Magnet track system-lights installation 48V**

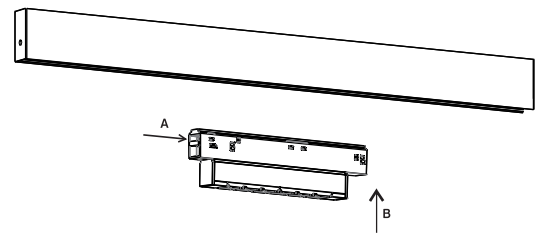





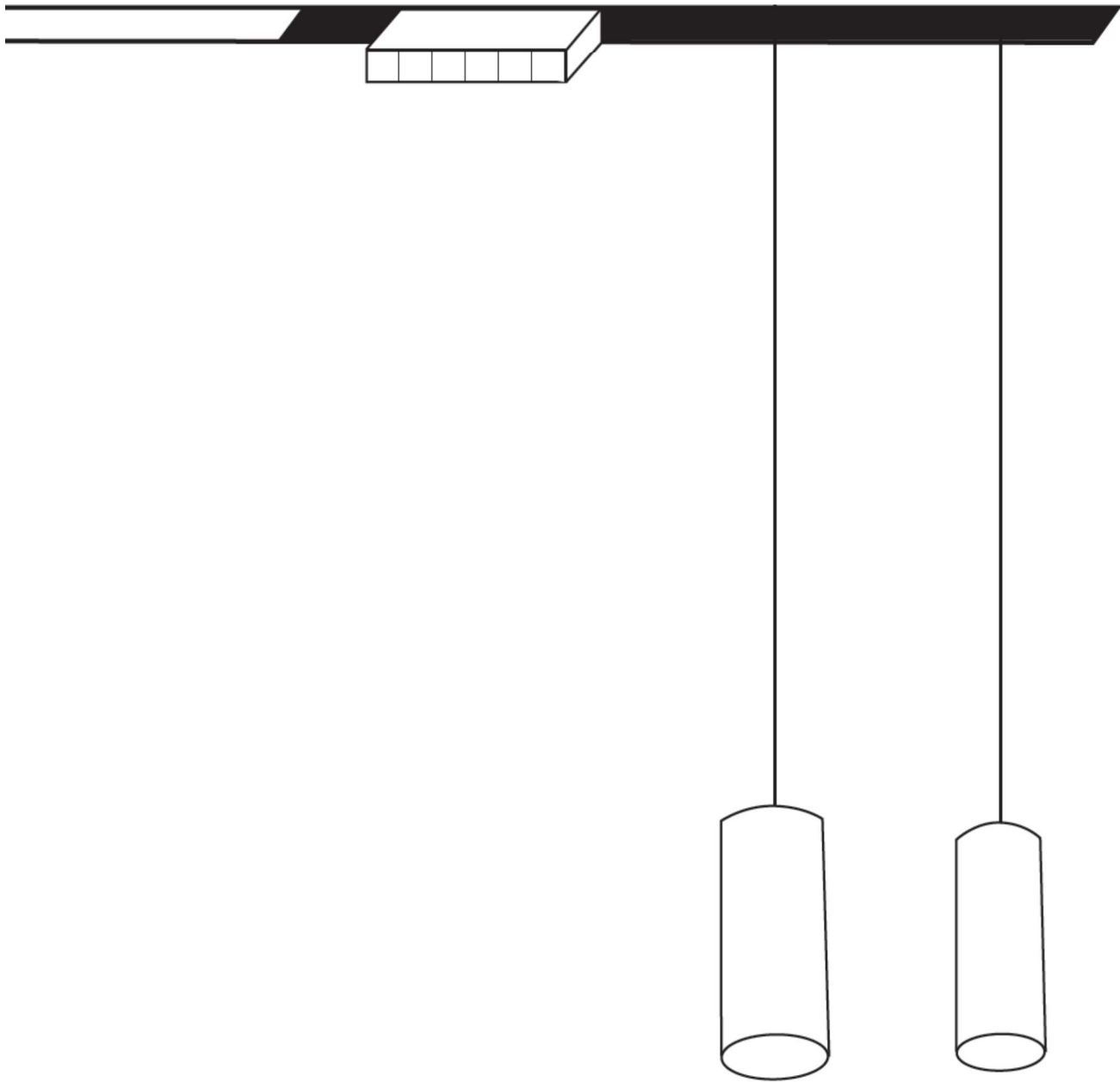

LED Magnetic Track lights 24v



**VK/04203TR/R**



**Product Models**

Code	Model	Box
71164-001721	VK/04203TR/R/1/B ■ Black sand. 24V. 1m (L100.5cm).	1pc
71164-002721	VK/04203TR/R/1.5/B ■ Black sand. 24V. 1.5m (L150.5cm).	1pc
71164-003721	VK/04203TR/R/2/B ■ Black sand. 24V. 2m (L200.5cm).	1pc

**Details**

Magnetic recessed track line 24V. Length 1-2m. IP Rating IP20. Working temperature < 45°C. Material Aluminium.

**IP20.**



4a. Check cut out size, then cut the hole in position.

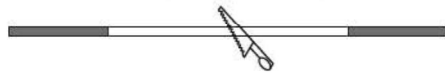

4b. Connect driver output side with track line.

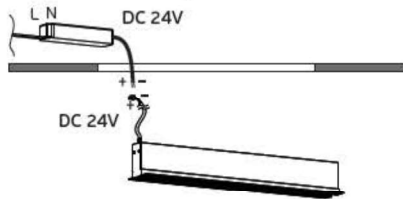

4c. Put the track into the hole, use screw to fix and instal this decorative film into track.

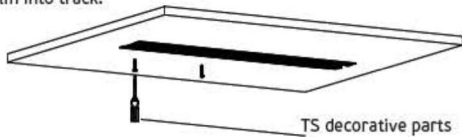

4d. Apply plaster ont the track

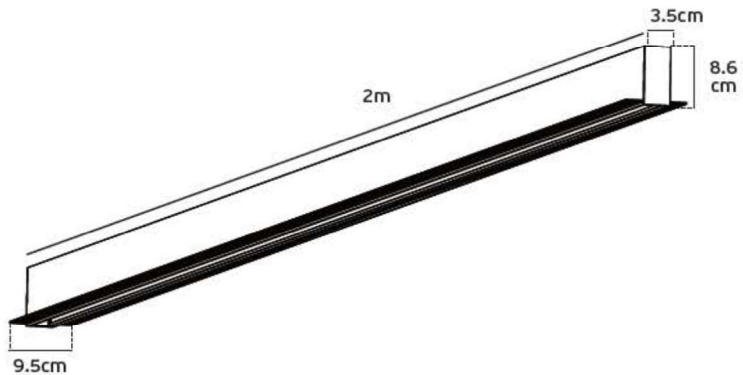
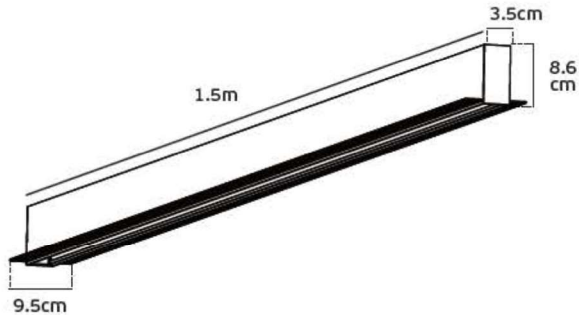
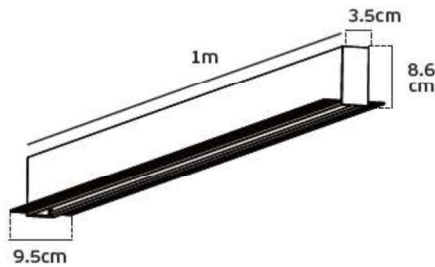

VK/04203TR/S

## Product Models

## surface/pendant



Code	Model	Box
71164-004721	VK/04203TR/S/1/B ■ Black sand. 24V. 1m. (L100.5cm)	1pc
71164-005721	VK/04203TR/S/1.5/B ■ Black sand. 24V. 1.5m (L150.5cm)	1pc
71164-006721	VK/04203TR/S/2/B ■ Black sand. 24V. 2m. (L200.5cm)	1pc

## Details

Magnetic surface mounted track line 24V. Length 1-2m. IP Rating IP20.  
Working temperature < 45°C. Material Aluminium.

IP20.

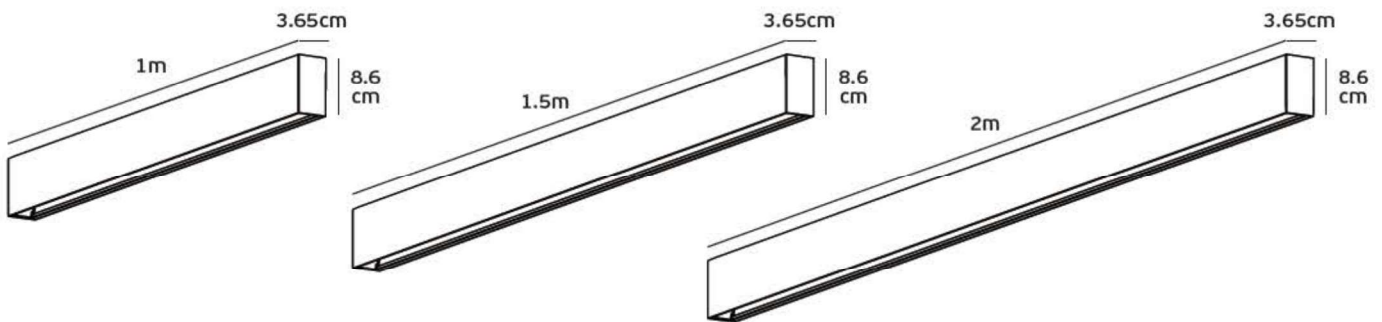

## surface

A. Use screw fix TS-S installation support on the ceiling.

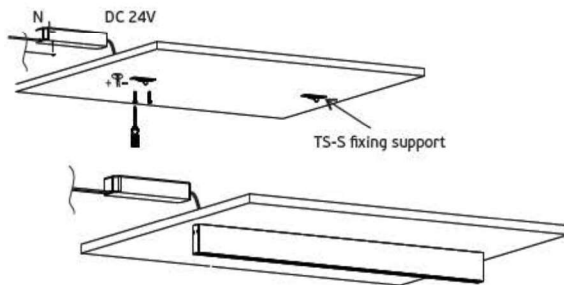

B. Connect driver output side with track power line, then fix TS-TS track with TS-TS support.

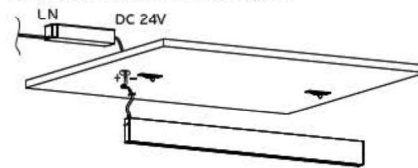

## pendant

A. Fixed TS-TP track ceiling box on ceiling with screw.

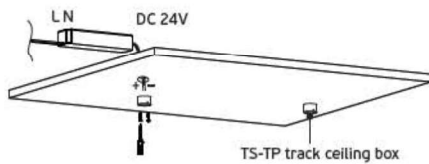

B. Connect driver output side with track line, and fixed TS-TP ceiling cover and TS-TP box cover with M4 screw.

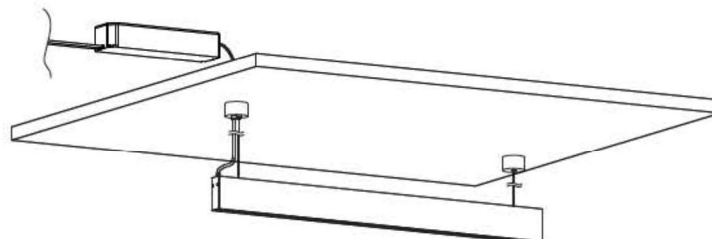
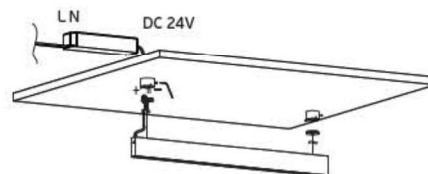

**VK/04212TR/R/INN/B**



**Product Models**

Code	Model	Box
71164-022721	VK/04212TR/R/INN/B ■ Sand Black. Inner Corner recessed.	1pc

**Details**

Inner corner recessed. Connect 2 rails link at an angle of 90°. Material Aluminium.

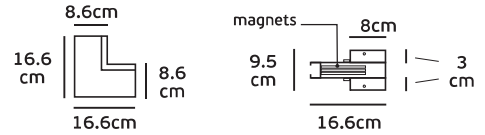

**VK/04212TR/R/OUT/B**



**Product Models**

Code	Model	Box
71164-023721	VK/04212TR/R/OUT/B ■ Sand Black. Outer Corner recessed.	1pc

**Details**

Outer corner recessed. Connect 2 rails link at an angle of 90°. Material Aluminium.

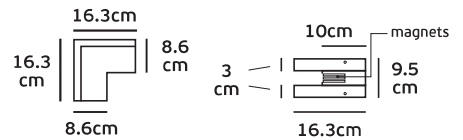

**VK/04213TR/R/L-R/B**



**Product Models**

Code	Model	Box
71164-024721	VK/04213TR/R/L-R/B ■ Sand Black. Left/Right Corner recessed.	1pc

**Details**

Left/Right corner recessed. Connect 2 rails link at an angle of 90°. Material Aluminium.

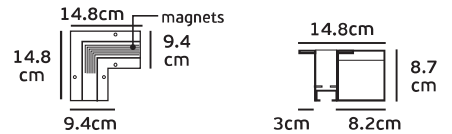

**VK/04214TR/S/INN/B**



**Product Models**

Code	Model	Box
71164-026721	VK/04214TR/S/INN/B ■ Sand Black. Inner Corner.	1pc

**Details**

Inner corner. Connect 2 rails link at an angle of 90°. Material Aluminium.

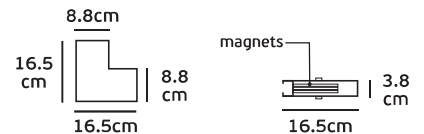

**VK/04214TR/S/OUT/B**



**Product Models**

Code	Model	Box
71164-027721	VK/04214TR/S/OUT/B ■ Sand Black. Outer Corner.	1pc

**Details**

Outer corner. Connect 2 rails link at an angle of 90°. Material Aluminium.

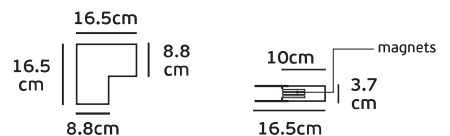

VK/04215TR/S/L-R/B



Product Models

Code	Model	Box
71164-028721	VK/04215TR/S/L-R/B ■ Sand Black. Left/Right corner.	1pc

**Details**  
Left/Right Corner. Connect 2 rails link at an angle of 90°. Material Aluminium.

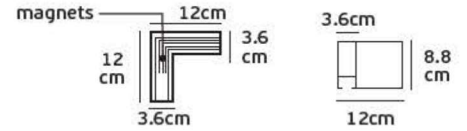

VK/04216TR/R/CON/B



Product Models

Code	Model	Box
71164-030721	VK/04216TR/R/CON/B ■ Sand Black. Connection accessory.	1pc

**Details**  
Connection accessory for magnetic recessed track. Material Aluminium.

VK/04216TR/P/CON/B



Product Models

Code	Model	Box
71164-031721	VK/04216TR/P/CON/B ■ Sand Black. Connection accessory.	1pc

**Details**  
Connection accessory for magnetic recessed track. Material Aluminium.

VK/04217TR/PC/B



Product Models

Code	Model	Box
71164-032721	VK/04217TR/PC/B ■ Sand Black. Power Connection accessory.	1pc

**Details**  
Power Connection accessory for magnetic recessed track. Material Aluminium.

VK/04203TR/SRK

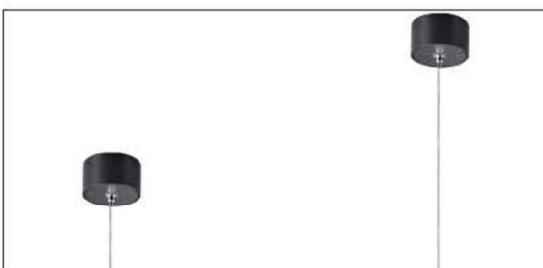

Product Models

Code	Model	Box
71164-007721	VK/04203TR/SRK ■ Sand Black. 1m hanging kit.	1pc

**Details**  
Material Aluminium. 1m hanging kit.

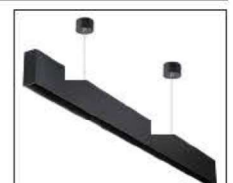

VK/04218TR/COV/B

Product Models

**Code**  
71164-033721

**Model**  
VK/04218TR/COV/B  
■ Black sand. Cover 1 meter.

**Box**  
1pc



Details

Cover for magnetic track lights 24V, decoration bar for recessed or surface tracks.  
IP Rating IP20. Working temperature < 45°C. Material Acrylic.

IP20.

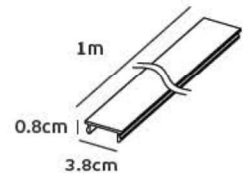



VK/LPV-60

**Product Models**

Code	Model	Box
78000-595663	VK/LPV-60-24 2.5A. 60w. 24V.	32pcs

**Details**

Voltage 100-240V. Watt 60w. Material Plastic housing. 2 years guarantee.



IP67. 60w.



VK/LPV-100

**Product Models**

Code	Model	Box
78000-660255	VK/LPV-100-24 4.2A. 100w. 24V.	20pcs

**Details**

Voltage 100-240V. Watt 100w. Material Plastic housing. 2 years guarantee.



IP67. 100w.



VK/LPV-150

**Product Models**

Code	Model	Box
78000-635255	VK/LPV-150-24 6.3A. 150w. 24V.	20pcs

**Details**

Voltage 180-305V. Watt 150w. Material Plastic housing. 2 years guarantee.



IP67. 150w.



**VK/04207TR/LIN37**



**Product Models**

Code	Model	Box
71164-013721	VK/04207TR/W/LIN37/B ■ Black sand. 3000K. 440lm. 12w. <i>bridgelux</i> . led. 110°. CRI>90	10pcs
71164-040721	VK/04207TR/C/LIN37/B ■ Black sand. 4000K. 440lm. 12w. <i>bridgelux</i> . led. 110°. CRI>90	10pcs

**Details**

Led magnetic track light DC Driver 24V. Watt 12w. Beam Angle 110°. Type of Led *bridgelux*. 2835. Lifetime 50.000hrs. Working temperature < 45°C. Material Aluminium. 2 years guarantee.

**IP20. 12w.**

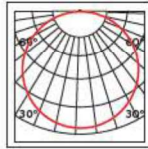

**VK/04207TR/LIN56**



**Product Models**

Code	Model	Box
71164-014721	VK/04207TR/W/LIN56/B ■ Black sand. 3000K. 680lm. 18w. <i>bridgelux</i> . led. 110°. CRI>90	30pcs
71164-041721	VK/04207TR/C/LIN56/B ■ Black sand. 4000K. 680lm. 18w. <i>bridgelux</i> . led. 110°. CRI>90	30pcs

**Details**

Led magnetic track light DC Driver 24V. Watt 18w. Beam Angle 110°. Type of Led *bridgelux*. 2835. Lifetime 50.000hrs. Working temperature < 45°C. Material Aluminium. 2 years guarantee.

**IP20. 18w.**

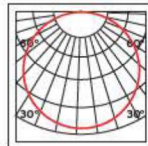

**VK/04207TR/LIN74**



**Product Models**

Code	Model	Box
71164-015721	VK/04207TR/W/LIN74/B ■ Black sand. 3000K. 1.050lm. 24w. <i>bridgelux</i> . led. 110°. CRI>90	12pcs
71164-042721	VK/04207TR/C/LIN74/B ■ Black sand. 4000K. 1.050lm. 24w. <i>bridgelux</i> . led. 110°. CRI>90	12pcs

**Details**

Led magnetic track light DC Driver 24V. Watt 24w. Beam Angle 110°. Type of Led *bridgelux*. 2835. Lifetime 50.000hrs. Working temperature < 45°C. Material Aluminium. 2 years guarantee.

**IP20. 24w.**

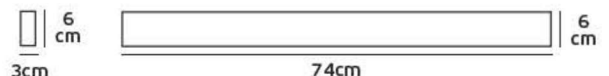
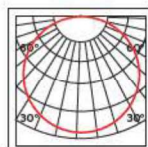

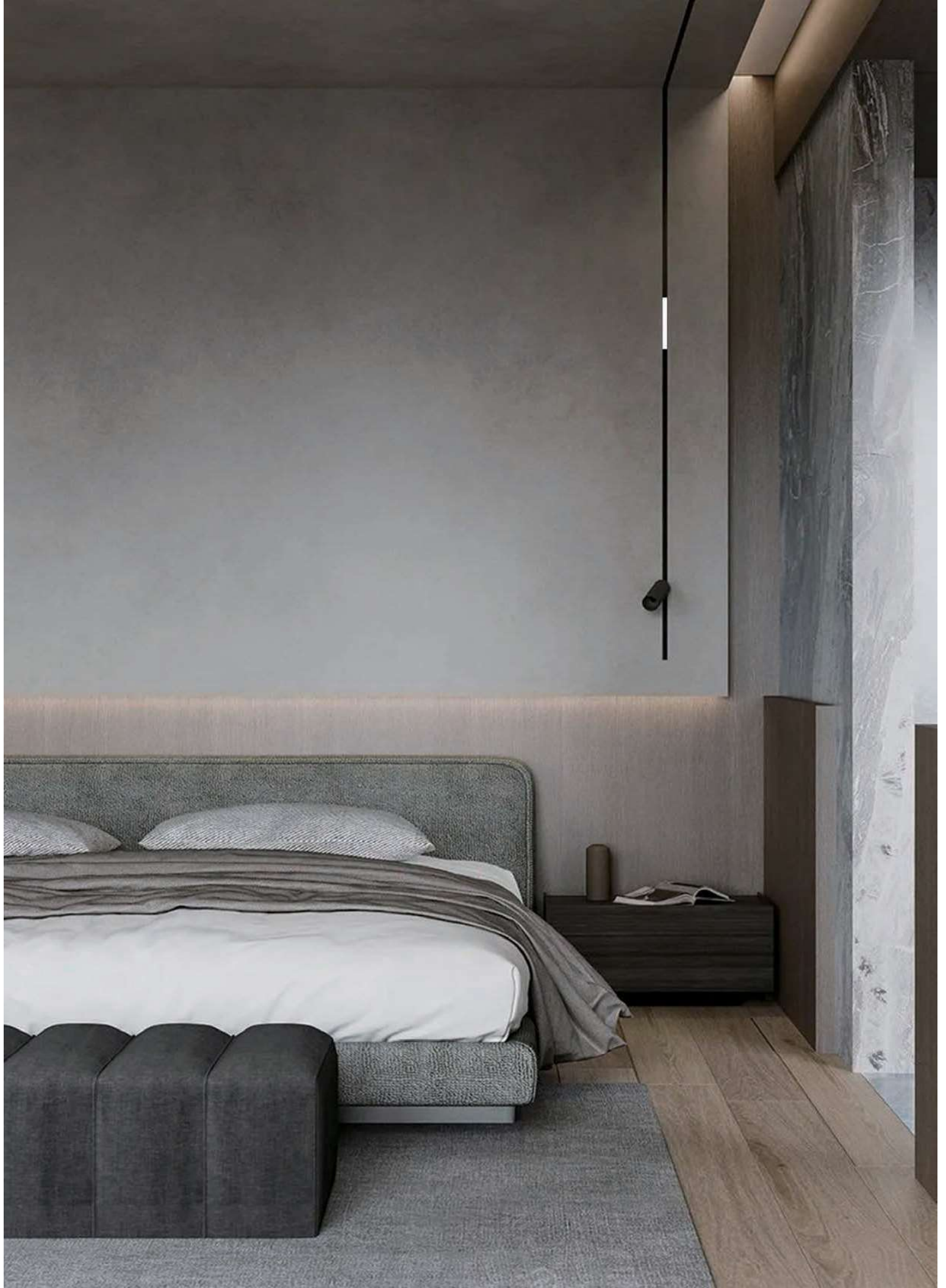



VK/04204TR/3



Product Models

Code	Model	Box
71164-008721	VK/04204TR/W/3/B ■ Black sand. 3000K. 383lm. 6w. <i>bridgelux</i> . led. 8°. CRI>90	20pcs
71164-043721	VK/04204TR/C/3/B ■ Black sand. 4000K. 383lm. 6w. <i>bridgelux</i> . led. 8°. CRI>90	20pcs

Details

Led magnetic track light DC Driver 24V. Watt 6w. Beam Angle 8°. Type of Led *bridgelux*. Lifetime 50.000hrs. Working temperature < 45°C. Material Aluminium. 2 years guarantee.

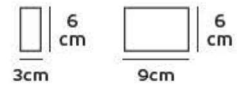
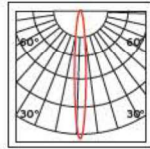

VK/04204TR/6



Product Models

Code	Model	Box
71164-009721	VK/04204TR/W/6/B ■ Black sand. 3000K. 756lm. 12w. <i>bridgelux</i> . led. 8°. CRI>90	50pcs
71164-044721	VK/04204TR/C/6/B ■ Black sand. 4000K. 756lm. 12w. <i>bridgelux</i> . led. 8°. CRI>90	50pcs

Details

Led magnetic track light DC Driver 24V. Watt 12w. Beam Angle 8°. Type of Led *bridgelux*. Lifetime 50.000hrs. Working temperature < 45°C. Material Aluminium. 2 years guarantee.

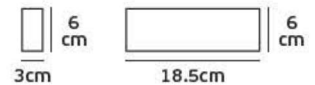
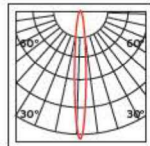

VK/04204TR/12



Product Models

Code	Model	Box
71164-010721	VK/04204TR/W/12/B ■ Black sand. 3000K. 1.408lm. 24w. <i>bridgelux</i> . led. 8°. CRI>90	10pcs
71164-046721	VK/04204TR/C/12/B ■ Black sand. 4000K. 1.408lm. 24w. <i>bridgelux</i> . led. 8°. CRI>90	10pcs

Details

Led magnetic track light DC Driver 24V. Watt 24w. Beam Angle 8°. Type of Led *bridgelux*. Lifetime 50.000hrs. Working temperature < 45°C. Material Aluminium. 2 years guarantee.

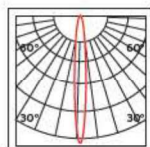

## VK/04205TR/6



## Product Models

Code	Model	Box
71164-011721	VK/04205TR/W/6/B ■ Black sand. 3000K. 756lm. 12w. <i>bridgelux</i> . led. 8°. CRI>90	20pcs
71164-045721	VK/04205TR/C/6/B ■ Black sand. 4000K. 756lm. 12w. <i>bridgelux</i> . led. 8°. CRI>90	20pcs

## Details

Led magnetic track light DC Driver 24V. Watt 12w. Beam Angle 8°. Type of Led *bridgelux*. Lifetime 50.000hrs. Working temperature < 45°C. Material Aluminium. 2 years guarantee.



IP20. 12w.

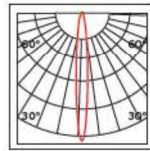

## VK/04206TR



Code	Model	Box
71164-012721	VK/04206TR/W/LIN/B ■ Black sand. 3000K. 348lm. 10w. <i>bridgelux</i> . led. 18°. CRI>90	30pcs
71164-039721	VK/04206TR/C/LIN/B ■ Sand Black. 4000K. 348lm. 10w. <i>bridgelux</i> . led. 18°. CRI>90	30pcs

## Details

Led magnetic track light DC Driver 24V. Watt 10w. CRI>90. Beam Angle 18°. Type of Led *bridgelux*. Lifetime 50.000hrs. Working temperature < 45°C. Material Aluminium. 2 years guarantee.



IP20. 10w.

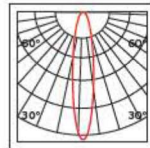

VK/04208TR/SP



Product Models

Code	Model	Box
71164-016721	VK/04208TR/W/SP/B ■ Black sand. 3000K. 480lm. 7w. 24°. CRI>90	30pcs
71164-047721	VK/04208TR/C/SP/B ■ Black sand. 4000K. 480lm. 7w. 24°. CRI>90	30pcs

Details

Led magnetic track light DC Driver 24V. Watt 7w. Beam Angle 24°. Type of Led CREE CXA 1304. Lifetime 50.000hrs. Working temperature < 45°C. Material Aluminium. 2 years guarantee.



IP20. 7w.

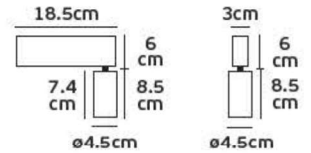
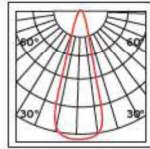

VK/04209TR/SP



Product Models

Code	Model	Box
71164-017721	VK/04209TR/W/SP/B ■ Black sand. 3000K. 850lm. 12w. 24°. CRI>90	20pcs
71164-038721	VK/04209TR/C/SP/B ■ Black sand. 4000K. 850lm. 12w. 24°. CRI>90	20pcs

Details

Led magnetic track light DC Driver 24V. Watt 12w. Beam Angle 24°. Type of Led CREE CXA 1507. Lifetime 50.000hrs. Working temperature < 45°C. Material Aluminium. 2 years guarantee.



IP20. 12w.

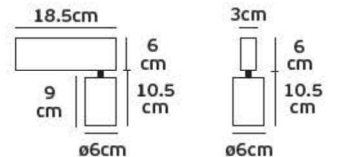
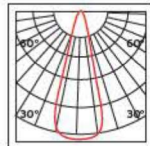

VK/04210TR/SP



Product Models

Code	Model	Box
71164-018721	VK/04210TR/W/SP/B ■ Black sand. 3000K. 2.220lm. 28w. 24°. CRI>90	12pcs
71164-048721	VK/04210TR/C/SP/B ■ Black sand. 4000K. 2.220lm. 28w. 24°. CRI>90	12pcs

Details

Led magnetic track light DC Driver 24V. Watt 28w. Beam Angle 24°. Type of Led CREE CXA 1816. Lifetime 50.000hrs. Working temperature < 45°C. Material Aluminium. 2 years guarantee.



IP20. 28w.

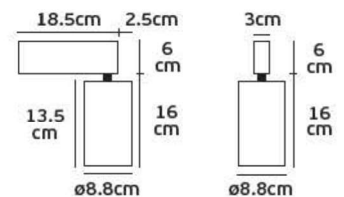
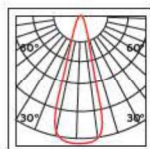



VK/04208TR/SP/3

Product Models

Code	Model							Box
71164-019721	VK/04208TR/W/SP/3/B ■ Black sand.	3000K.	1.100lm.	21w.	24°.		CRI>90	12pcs
71164-049721	VK/04208TR/C/SP/3/B ■ Black sand.	4000K.	1.100lm.	21w.	24°.		CRI>90	12pcs

Details

Led magnetic track light DC Driver 24V. Watt 21w. Beam Angle 24°. Type of Led CREE CXA 1304. Lifetime 50.000hrs. Working temperature < 45°C. Material Aluminium. 2 years guarantee.



IP20. 21w.

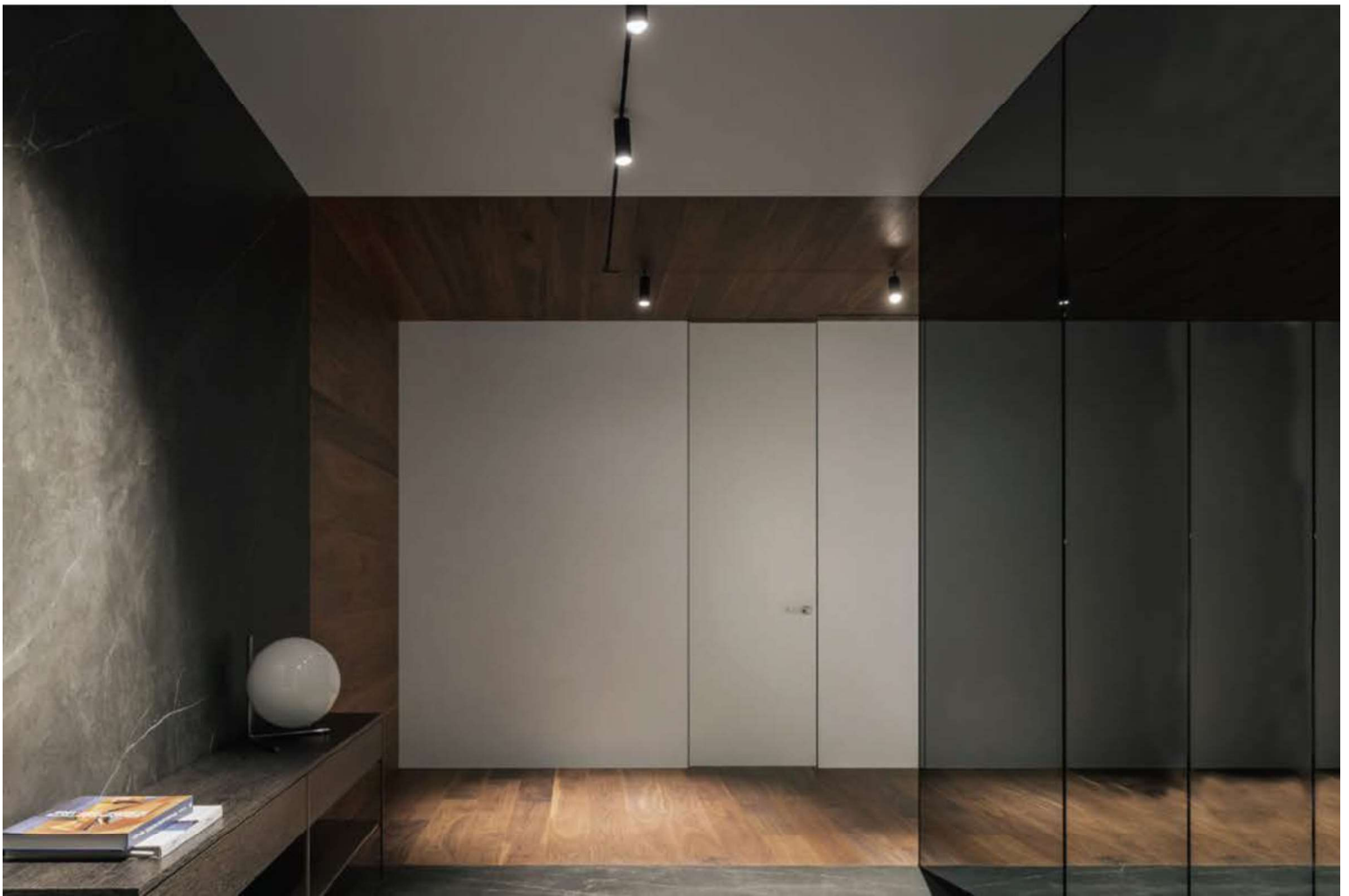
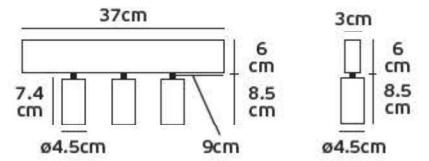
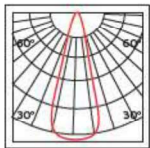

VK/04210TR/PE

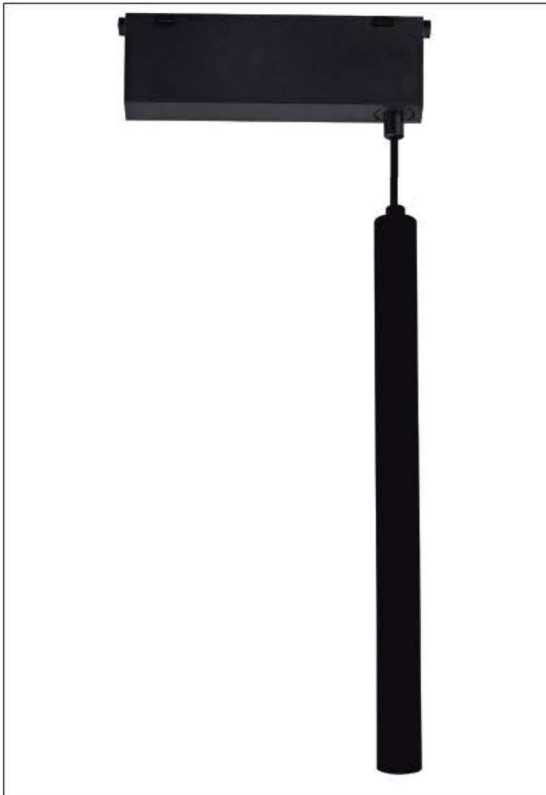

Product Models

Code	Model	Box
71164-020721	VK/04210TR/W/PE/B ■ Black sand. 3000K. 92lm. 3w. 15°. CRI>90	12pcs
71164-050721	VK/04210TR/C/PE/B ■ Black sand. 4000K. 92lm. 3w. 15°. CRI>90	12pcs

Details

Led magnetic track light DC Driver 24V. Watt 3w. Beam Angle 15°. Type of Led CREE XP-E2. Lifetime 50.000hrs. Working temperature < 45°C. Material Aluminium. 2 years guarantee.



**IP20. 3w.**

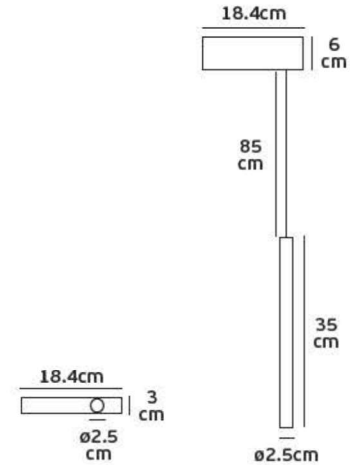
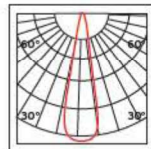

VK/04211TR/PE



Product Models

Code	Model	Box
71164-021721	VK/04211TR/W/PE/B ■ Black sand. 3000K. 558lm. 7w. 24°. CRI>90	10pcs
71164-051721	VK/04211TR/C/PE/B ■ Black sand. 4000K. 558lm. 7w. 24°. CRI>90	10pcs

Details

Led magnetic track light DC Driver 24V. Watt 7w. Beam Angle 24°. Type of Led CREE CXA 1304. Lifetime 50.000hrs. Working temperature < 45°C. Material Aluminium. 2 years guarantee.



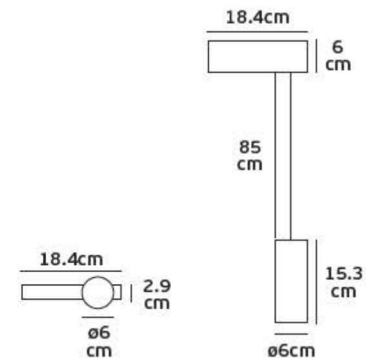
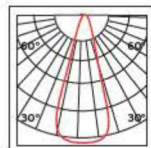

**IP20. 7w.**

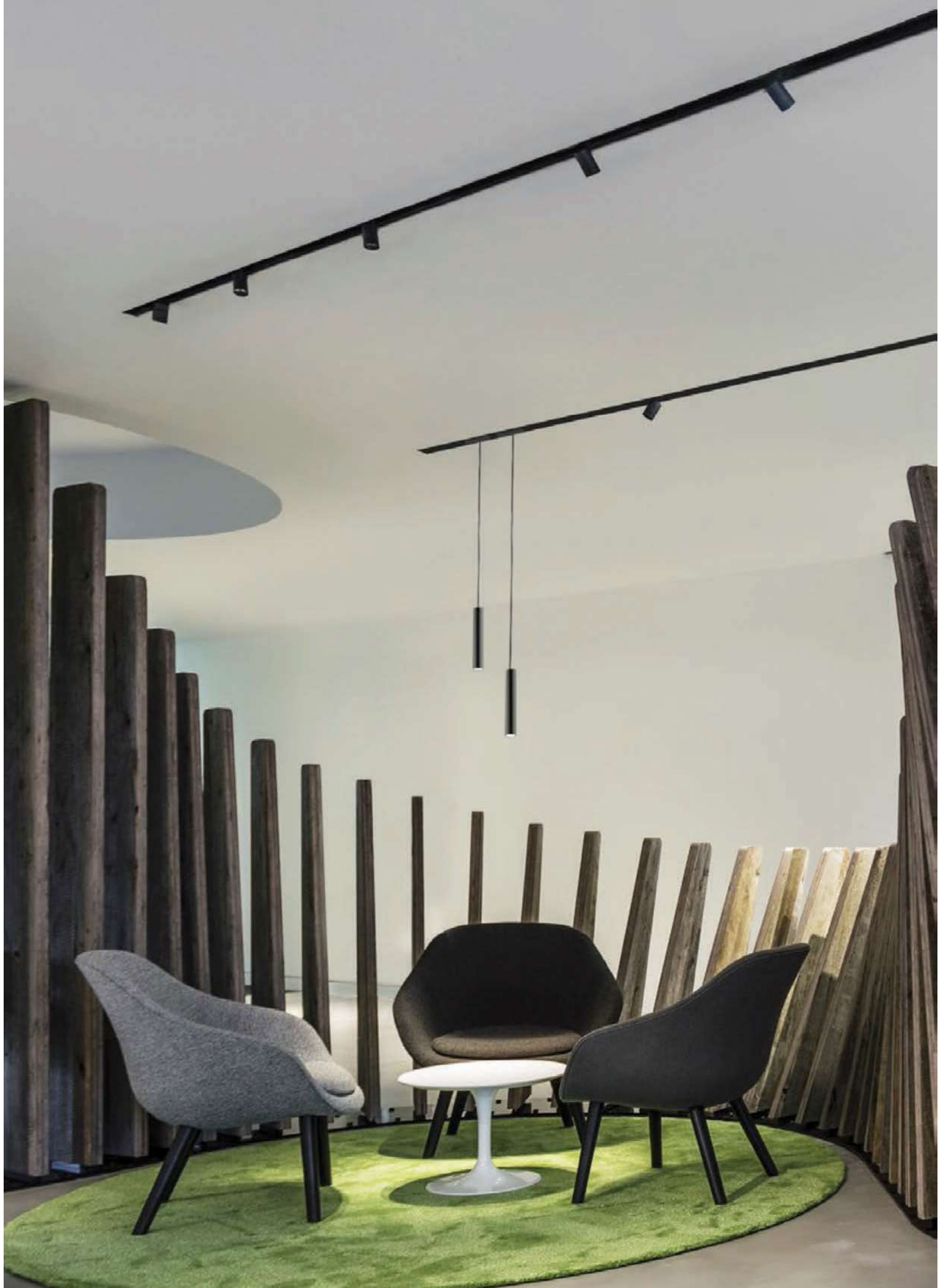

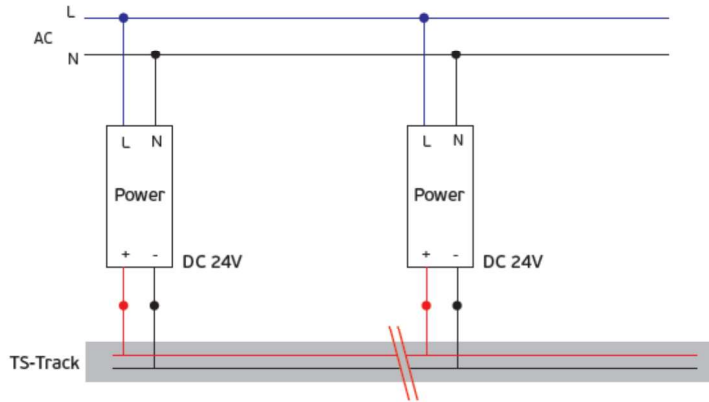

**Συνδεσμολογία Μαγνητικής Ράγας**  
**Magnet Track System Electrical Diagram**



Note: When all lights power is bigger than load power, need to add one new driver into track.

(driver is near track installation position easily to install)  
 Before install track, put the driver into ceiling, caculate driver power and lights power. Lights power must be smaller than driver's power. If is bigger, need to add one more driver.

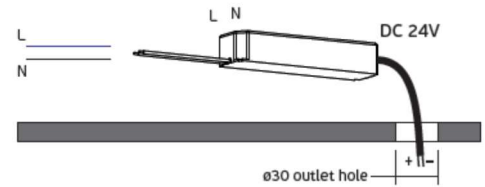

- Driver**  
 LPV-60-24//AC:100-240V DC:60W 24V  
 LPV-100-24//AC:100-240V DC:100W 24V  
 LPV-150-24//AC:100-240V DC:150W 24V

**Cut off electric supply before installation!**

**Πίνακας Διαστάσεων Κοπής**  
**Built-in Magnet Track System Cut out size List**

Product diagram	Model	Cut out size	Cut out figure
	TS-TR Track/1m TS-TR Track/1.5m TS-TR Track/2m	L1010xw 50mm L1510xw 50mm L2010xw 50mm	
	TR-R Inner Corner	L100xw 50mm	
	TR-R Out Corner	L100xw 50mm	
	TR-R90 Left Corner	L125xw 50mm	
	TR-R90 Right Corner	L125xw 50mm	

4a. Check cut out size, then cut the hole in position.

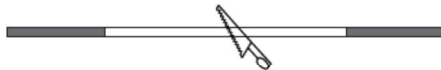

4b. Connect driver output side with track line.

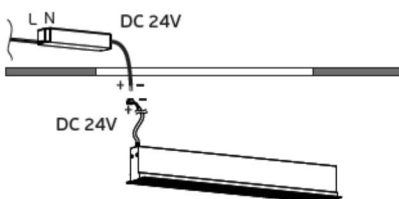

4c. Put the track into the hole, use screw to fix and instal this decorative film into track.

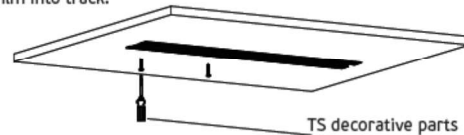

4d. Apply plaster on the track



## Οδηγίες Εγκατάστασης Χωνευτής Μαγνητικής Ράγας Recessed Magnet Track Installation Diagram

Product detail

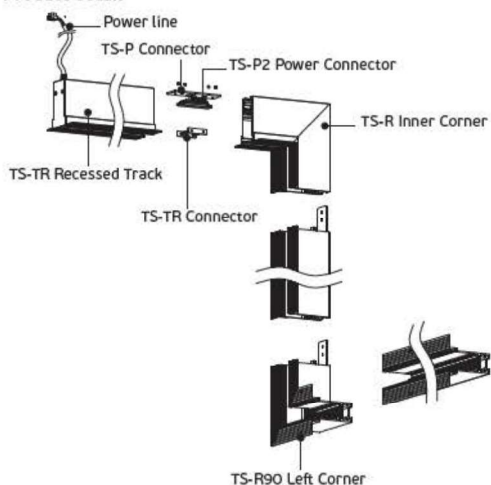

New connect driver: output line diagram

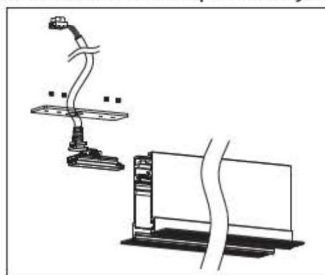

Recessed magnet track system connect

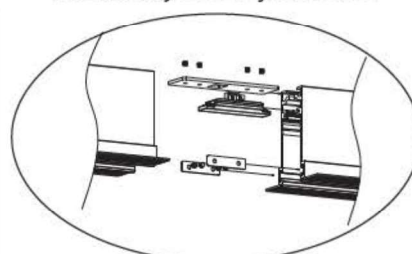

Figure 1

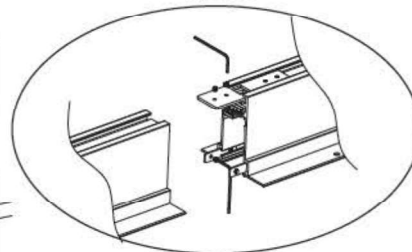
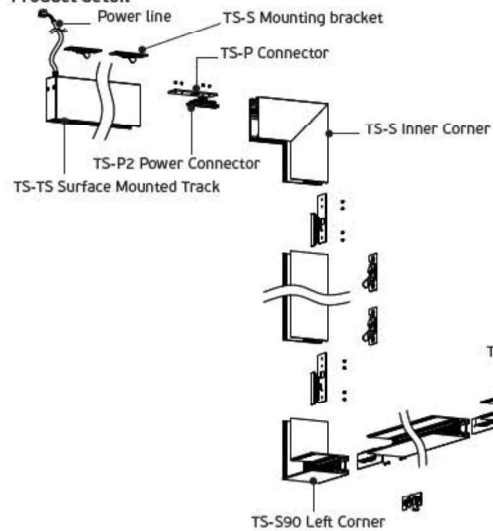

Figure 2

## Οδηγίες Εγκατάστασης Επιτοίχιας Μαγνητικής Ράγας Surface Mounted Magnet Track System Installation diagram

Product detail



New connect driver: output line diagram

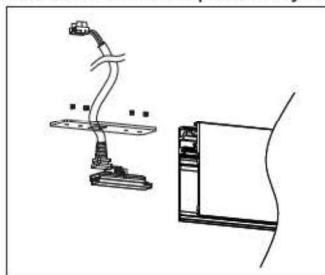

Surface mounted magnet track system connection diagram

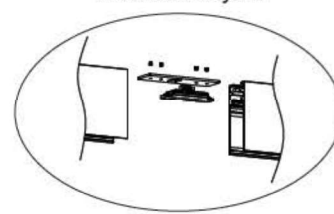

Figure 1

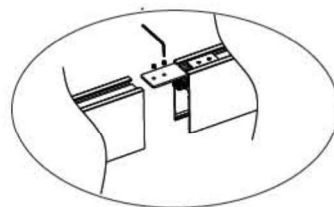
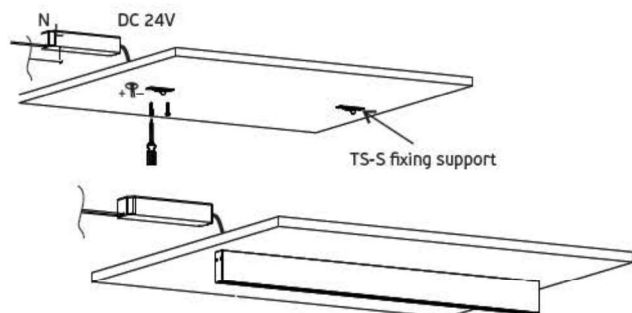
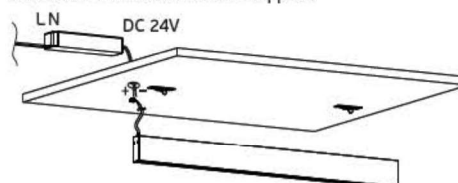

Figure 2

A. Use screw fix TS-S installation support on the ceiling.



B. Connect driver output side with track power line, then fix TS-TS track with TS-TS support.





**Οδηγίες Εγκατάστασης Κρεμαστής Μαγνητικής Ράγας**  
**Hanging Magnet Track System Installation Diagram**

Product detail

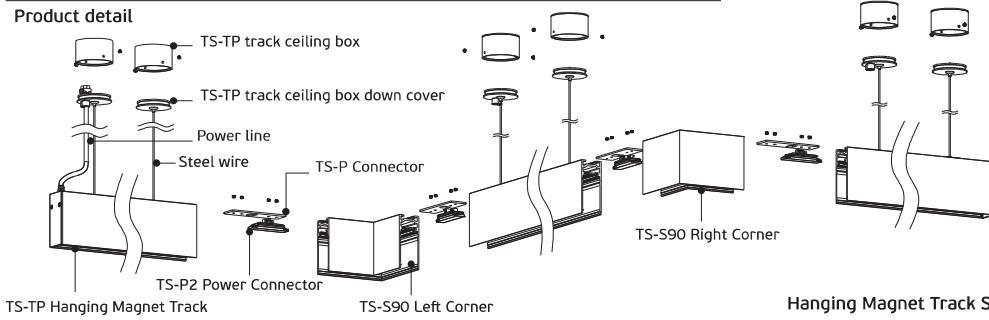

New connect driver: output line diagram

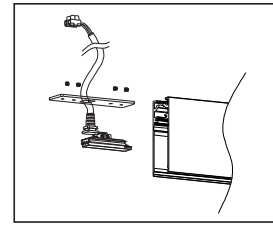

Hanging Magnet Track System Connection Diagram

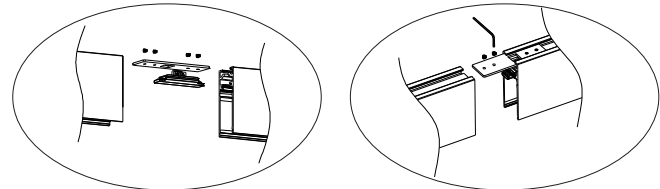
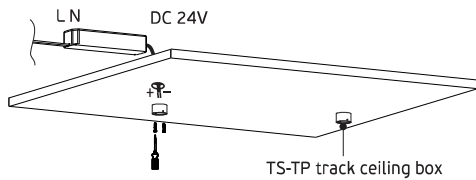

Figure 1

Figure 2

A. Fixed TS-TP track ceiling box on ceiling with screw.



B. Connect driver output side with track line, and fixed TS-TP ceiling cover and TS-TP box cover with M4 screw.

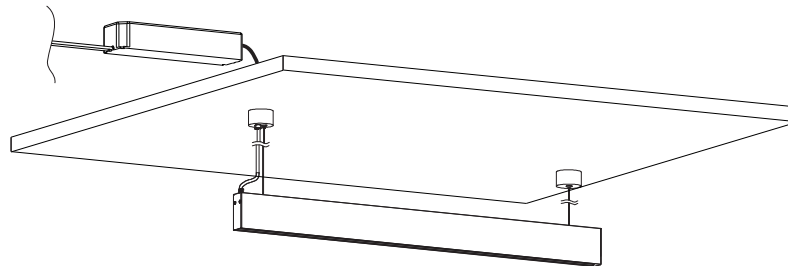
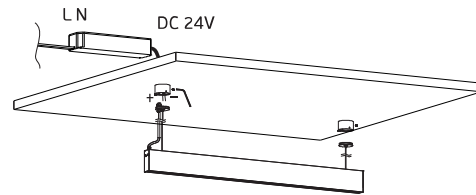

**Τρόπος Τοποθέτησης Φωτιστικών**  
**Magnet Track System-lights Installation**

Magnet track system, lights installation has Magnet and buckle style

